

Group G Controller for ASCO Automatic & Non-Automatic Transfer Switches

User's Guide

381333-400 H
10/2018

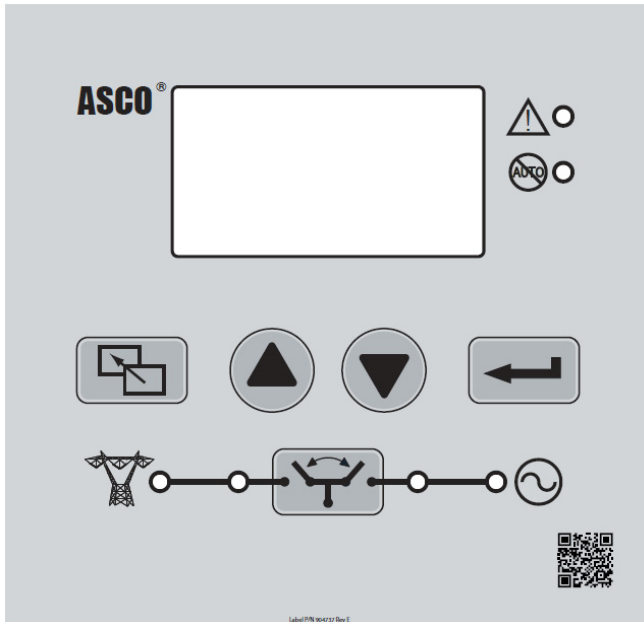

! DANGER

DANGER is used in this manual to warn of a hazard situation which, if not avoided, will result in death or serious injury.

! WARNING

WARNING is used in this manual to warn of a hazardous situation which, if not avoided, could result in death or serious injury.

! CAUTION

CAUTION is used in this manual to warn of a hazardous situation which, if not avoided, could result in minor or moderate injury.

To avoid severe equipment damage, the engine-generator set must have automatic shutdown devices, and the electrical system must have protective devices.

Refer to the outline and wiring drawings provided with the transfer switch for all installation and connection details and accessories.

Refer to the manual provided with the transfer switch for installation, functional testing, and troubleshooting.

Table of Contents

OVERVIEW	
Control Overview.....	2
Status Information.....	3
Source Acceptability.....	3
Screen Navigation.....	4
Sequence of Operation diagrams	
3ATS.....	5
3ADTS.....	6
3NTS.....	7
3NDTS.....	8
SETTINGS	
Settings Overview.....	9
Change a Setting, Password.....	9
Voltage and Frequency.....	10
Timers.....	11-12
General.....	13-14
Features.....	15-16
Engine Exercisers.....	17-18
View Event Log.....	19
View Statistics, View About.....	19
SCREEN MESSAGES	
Screen Messages and their Meanings.....	20-21
Control Messages and their Meanings.....	22
DESCRIPTION of OPERATION	
3ATS.....	23-24
3ADTS.....	25-26
3NTS.....	27-28
3NDTS.....	29-30
OPTIONAL ACCESSORIES	
Advanced Function Software Bundle.....	31
Current, Relay, and UPS Modules.....	32
Load Shed – Optional Accessory 30.....	32
APPENDIX	
Cover removal, DIP switches.....	33
Voltage adjustment and other settings.....	34
Logged Events.....	35
Event Causes and Statistics Kept.....	36
CALIFORNIA PROPOSITION 65 WARNING.....	37
INDEX.....	38-40

The Group G Controller handles the sensing, timing, and control functions for Automatic and Non-Automatic Transfer Switches (3ATS, 3ADTS, 3NTS, 3NDTS). This microprocessor-based controller includes a user interface. All monitoring and control functions can be done with the enclosure door closed for convenience and safety. Voltage pickup and dropout settings and time delay settings can be made through a system of menus.

Control Overview

The user interface includes a graphic display, control buttons, and indicator lights. Five buttons allow access to all monitoring, control, and settings functions. Six lights show status indication of source acceptability, transfer switch position, and alerts. The screens are arranged in three levels. Access to some screens require entering a password (indicated by a closed padlock symbol).

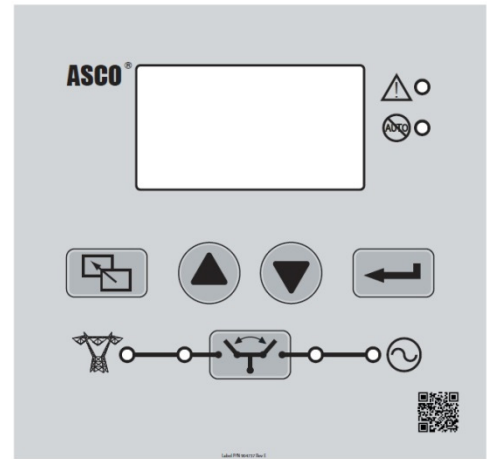

User Interface



Up-down arrows buttons

The up and down arrow buttons are used to navigate the settings. These buttons also increase and decrease a value to modify a parameter while in the settings level screens.



Enter/save settings button (see page 9 for *Are you sure?* screen)

The enter/save settings button moves from the status level to the Main Menu level and other levels. It also is used to select a parameter and to enter or save a new setting.



Escape button (see page 9 for *Are you sure?* screen)

The escape button ignores a change and returns to the previous status level.



Transfer button (see page 9 for *Are you sure?* screen)

The transfer button has several functions. Refer to the control message (bottom line) on the control status / home screen. A closed padlock symbol indicates that a password must be entered (see page 9).

- transfer test function simulates a failure of the normal source.
- for a 3NTS and 3NDTS, press this button to transfer or retransfer the load.
- bypass timer function cancels an active time delay
- abort function cancels a pending operation (inphase transfer, for example)

Four transfer switch status lights (light is on when:)

- Normal source accepted (left light)
- Emergency source accepted (right light)
- Load on normal [transfer switch in normal position]
- Load on emergency [transfer switch in emergency position]



Alert light (light is on when:) Read the display for more information.

- Any alarm condition turns on this light.



Not in automatic light (light is on when:)

- Not in automatic mode (manual); blinking indicates transfer inhibit.
For 3NTS and 3NDTS this light is always on, indicating that it is a manual transfer switch.
If Feature 6DL is active, the light is on when the load is transferred to emergency.

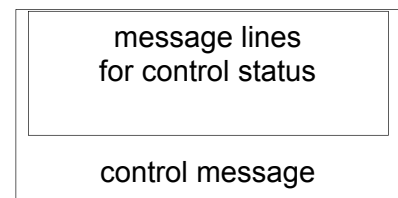

See pages 20, 21, 22

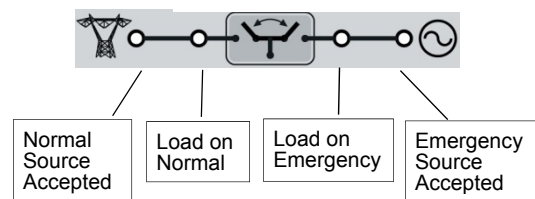

Status Information

The controller provides the status of both power sources (normal and emergency) and the position of the transfer switch. Press the up and down arrow buttons. No password is required to navigate through these screens.

3 message lines
for ATS position
other status

control message

ATS Status Screen

The ATS status is the home screen. It shows the present status of the ATS including: transfer sequence status, and running timers, status of connected source, and position of ATS. A control message appears below the status messages. The control message instructs the user on what action is available.

All other screens automatically return to the ATS Status screen (home screen) after five minutes of inactivity.

Metering Screen

One of several metering screens is provided (a factory setting). It shows the rms voltage and frequency readings of the power sources. If enabled, the voltage unbalance will also be displayed. If the current sensing option is provided, the load current is also displayed.

Alarm Screen

Active alarm message appear or *no active alarms*. A control message appears below the alarm message. If an active alarm must be acknowledged, the screen stays on until you press enter. Some alarms are self clearing.

Controller Screen

Controller information, name, location, present date and time appears. If an optional software key (dongle) is plugged into the controller, a key symbol is shown in upper right corner of this screen. Accessory 11BE is described on page 31.

Key indicates
optional software
key (dongle) installed
(Accessory 11BE)

Source Acceptability

(Feature 1C time delay is described on page 11.)

The controller considers a source unacceptable if any of these conditions are true:

- Any phase voltage of the source is less than the voltage dropout setting for more than the Feature 1C setting.
- Any phase voltage is greater than voltage trip setting for more than 3 seconds.
- Frequency of the source is less than the frequency dropout setting for more than Feature 1C setting.
- Frequency is greater than over-frequency trip setting for more than 3 seconds.
- The phase unbalance is greater than the unbalance dropout setting (only if enabled and 3 phase system).
- The phase rotation of the source does not match the reference phase rotation. (only if enabled and on 3 phase system).

The controller considers a source acceptable again when all these conditions are true:

- Each phase voltage is greater than the voltage pickup setting.
- Each phase voltage is less than over-voltage trip setting by more than 2% of nominal.
- The frequency of the source is greater than the frequency pickup setting.
- Frequency is less than the over-frequency trip setting by more than 2% of nominal.
- The phase unbalance is less than the unbalance pickup setting (only if enabled and 3 phase system).
- The phase rotation of the source matches the reference phase rotation. (only if enabled and on 3 phase system).

Screen Navigation

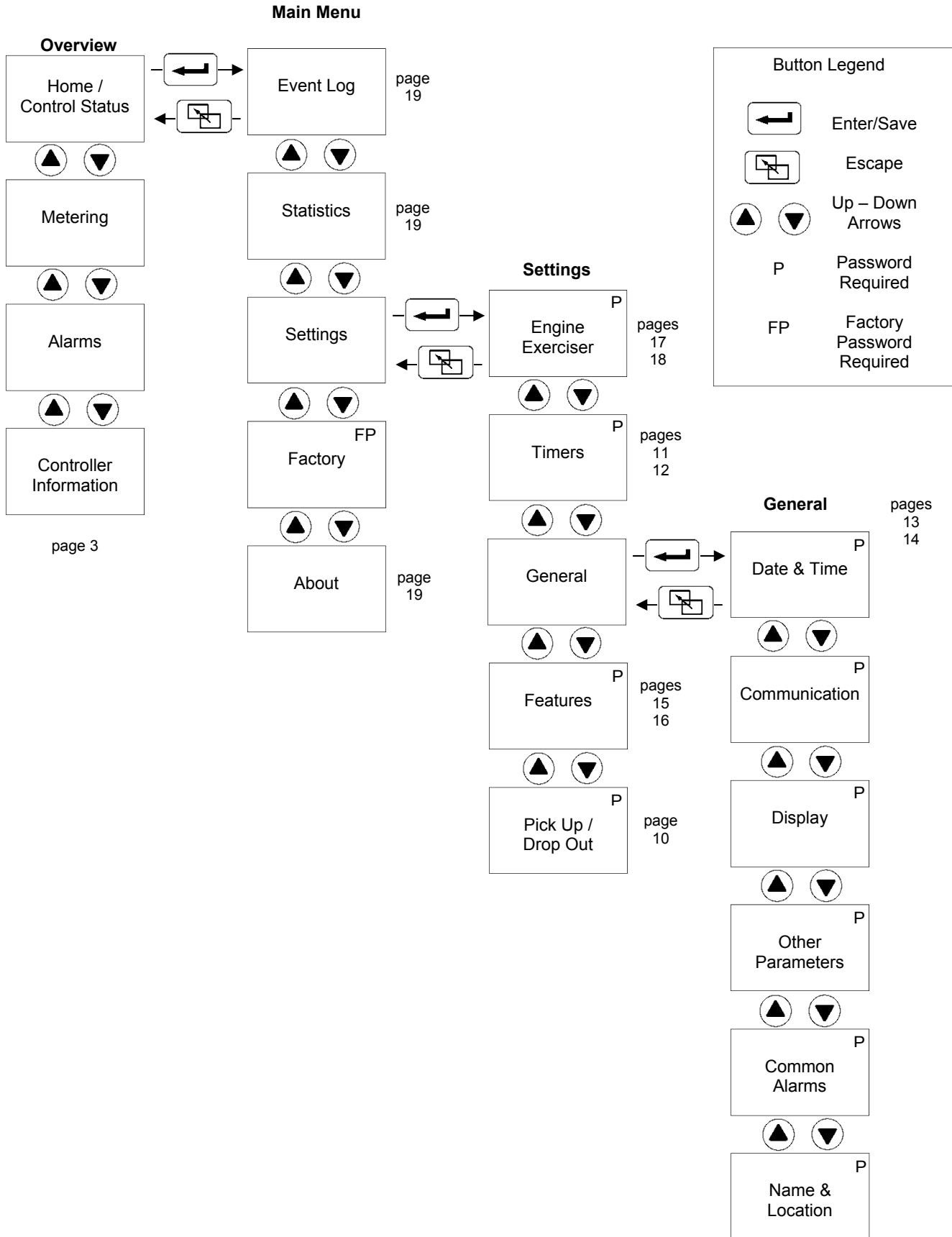

3ATS Sequence of Operation – Normal Source Failure

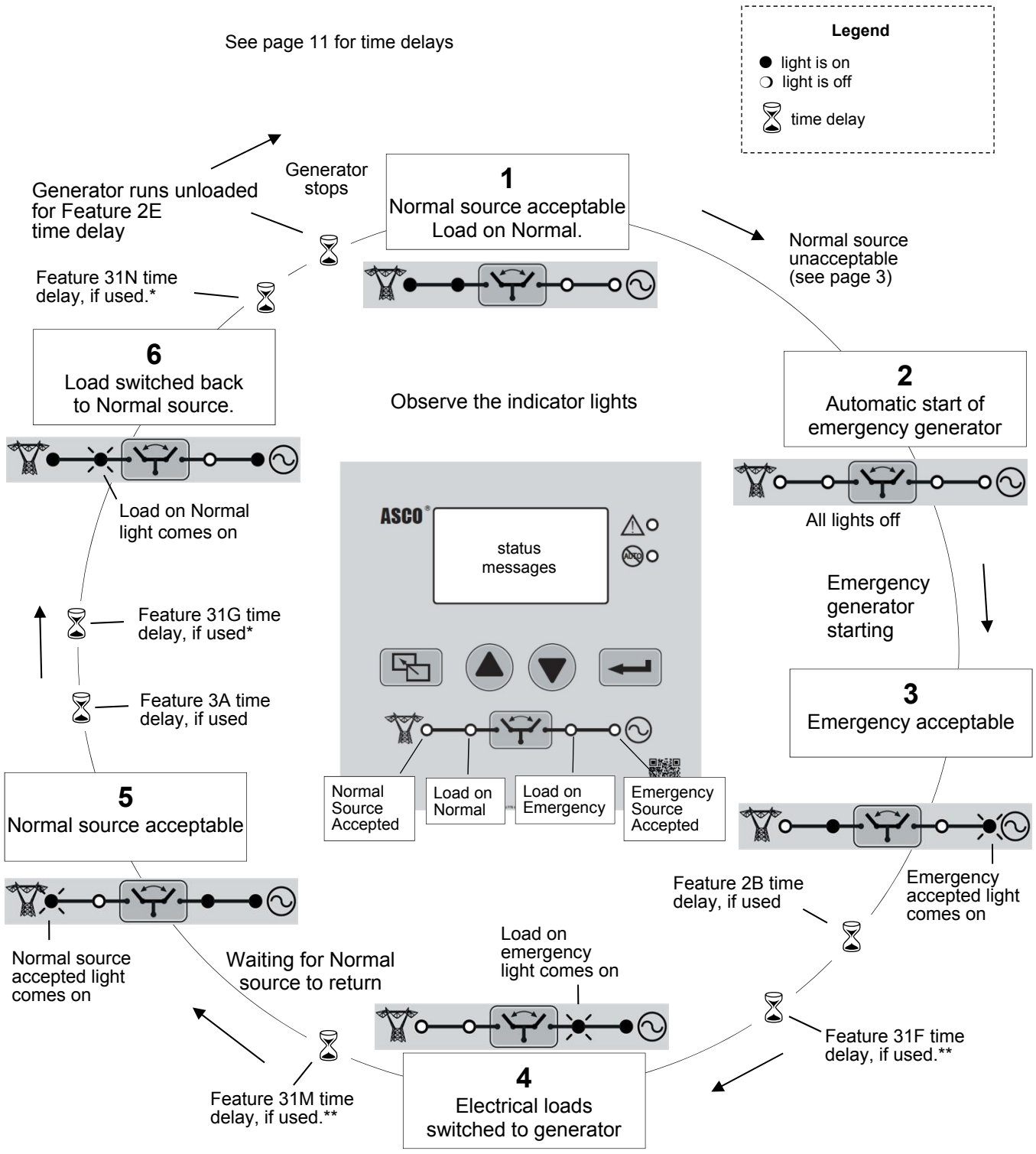

* To bypass **E** → **N** Feature 31G, 31N if connected source fails, set it to **yes** in Features settings.

** To bypass **N** → **E** Feature 31F, 31M if connected source fails, set it to **yes** in Features settings.

3ADTS Sequence of Operation – Normal Source Failure

See page 11 for time delays

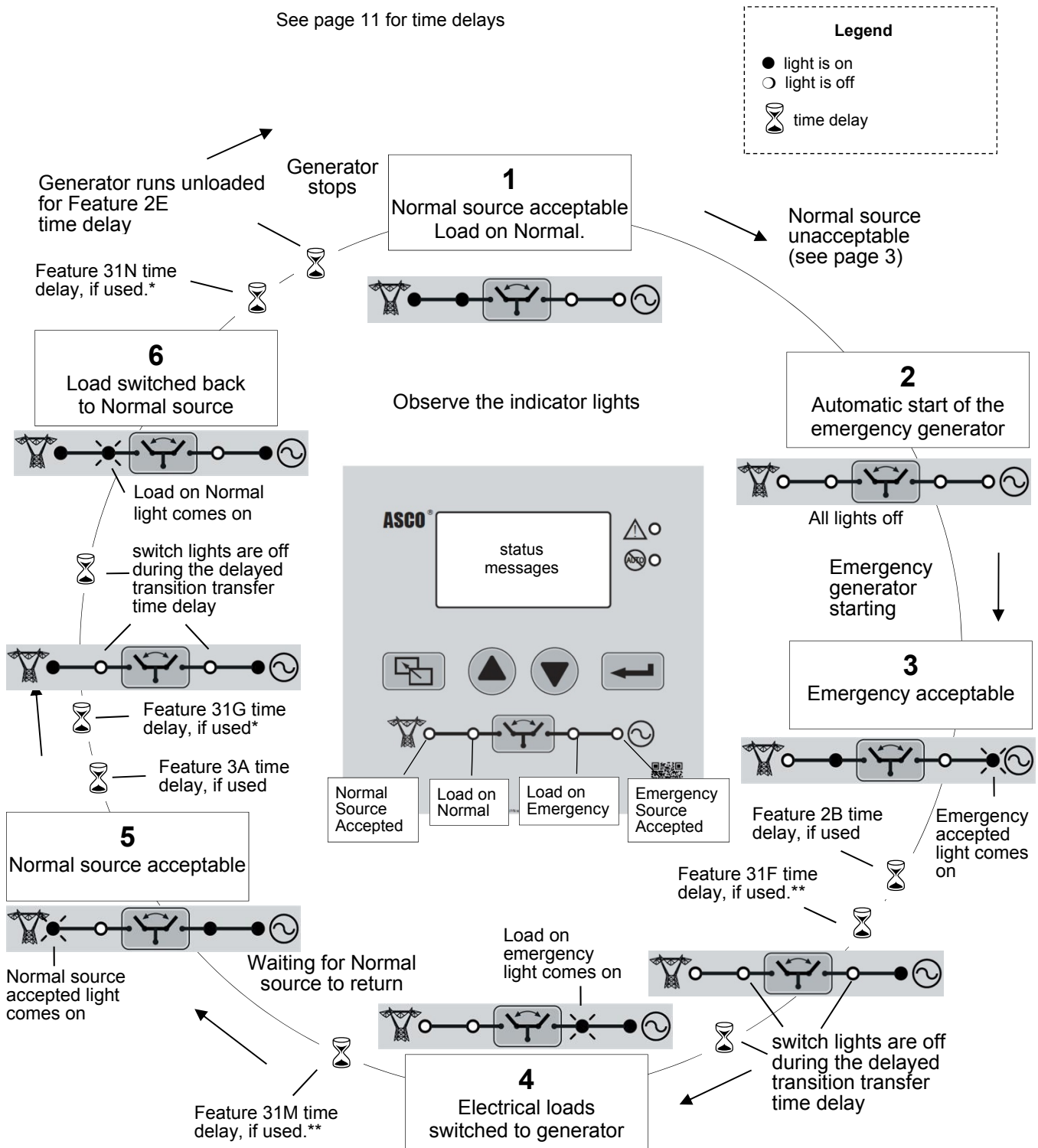

* To bypass E → N Feature 31G, 31N if connected source fails, set it to **yes** in Features settings.

** To bypass N → E Feature 31F, 31M if connected source fails, set it to **yes** in Features settings.

3NTS Sequence of Operation – Normal Source Failure

See page 11 for time delays (usually set to zero for 3NTS)

Legend

- light is on
- light is off
- ☞ press transfer button
- ⌚ time delay

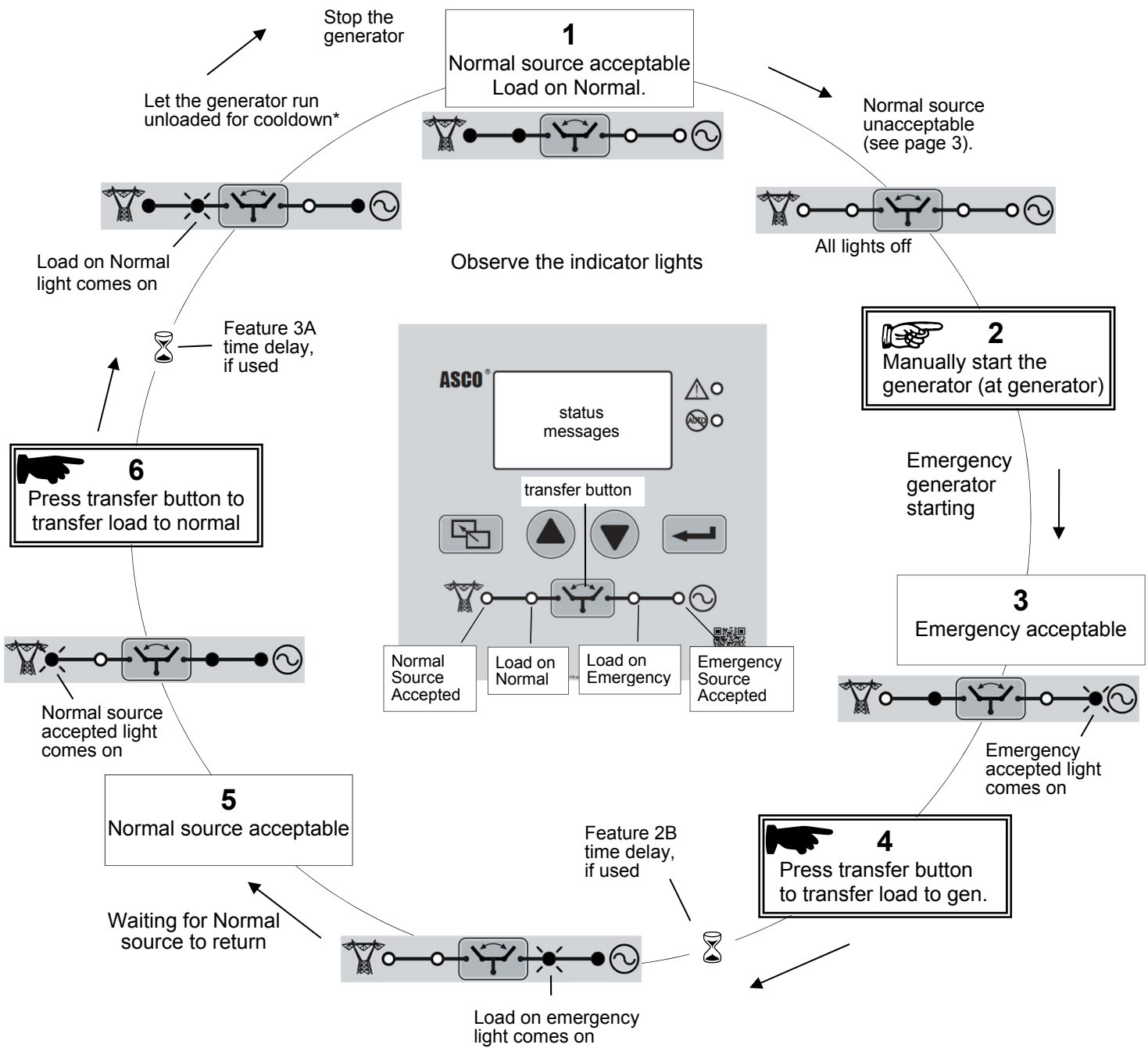

* Follow the generator manufacturer's recommendations.

3NDTS Sequence of Operation– Normal Source Failure

See page 11 for time delays (usually set to zero for 3NDTS)

Legend

- light is on
- light is off
- ☞ press transfer button
- ⌚ time delay
- 

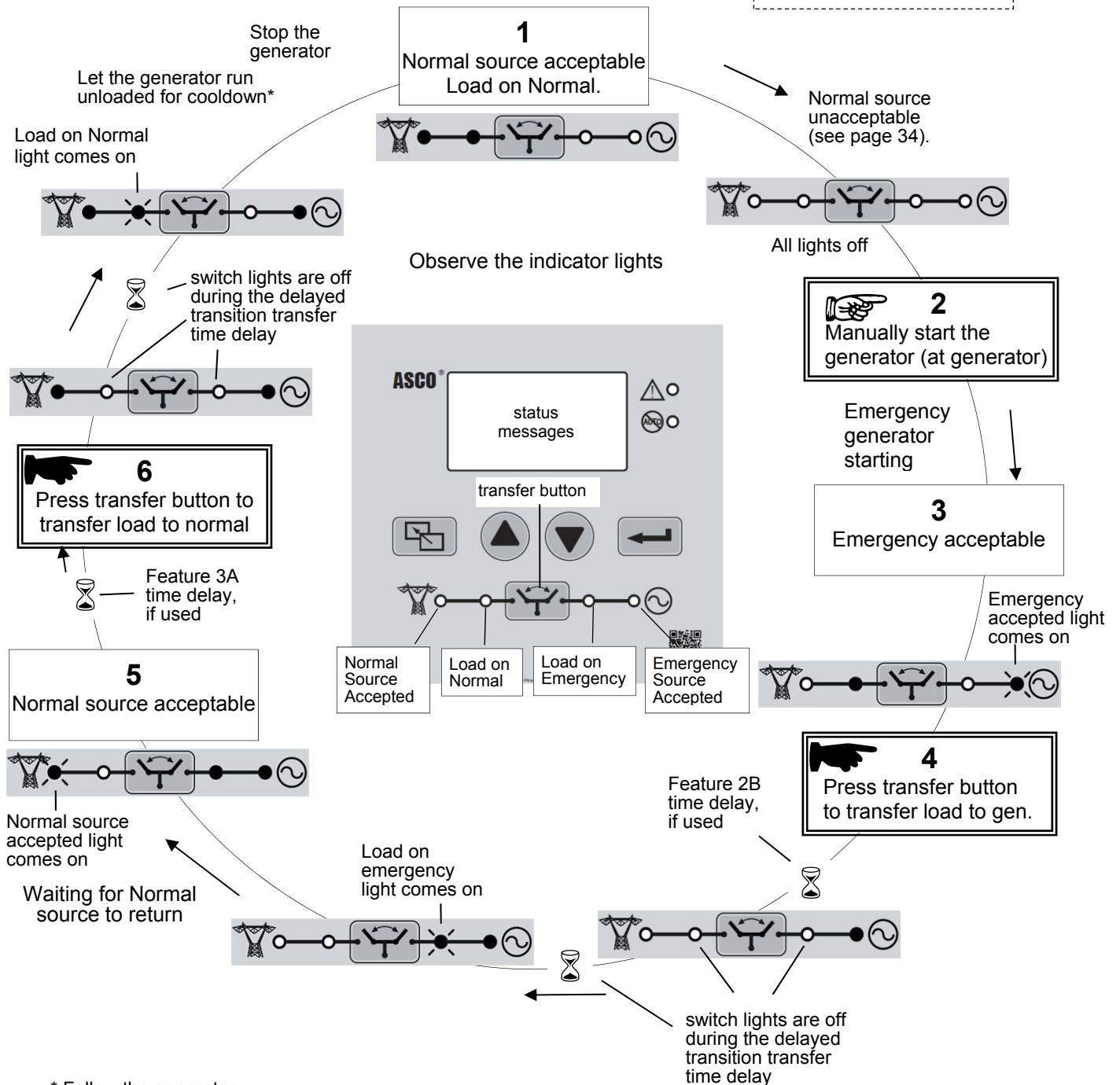

* Follow the generator manufacturer's recommendations.

Settings Overview (Main Menu ⇌ Settings)

NOTICE

Any indiscriminate change in these settings may affect the normal operation of the transfer switch. This change could allow the load circuits to remain connected to an inadequate source.

The settings can be displayed and changed from the user interface. Some settings may require a password.

1. On the ATS Status screen, press the enter/save button to display to the **Main Menu** screen.
2. On the **Main Menu** screen, press the up or down arrow buttons to select **Settings**, then press the enter/save button.
3. On the **Settings** screen, press the up or down arrow buttons to select a parameter, then press the enter/save button.

Change a Setting

To change a setting in the controller:

1. Navigate to the settings screen that you want to change.
2. Press the enter/save settings button to start the first field blinking. If required, enter the password.
3. Press the up and down arrow buttons to change the flashing digit(s) or word, and press the enter/save settings button to move to the next field.
4. Repeat step 3 until all the fields have been entered.

NOTE If a field is blinking, information must be entered. The escape button will end the editing session.

Password The default password is 1111 (see pages 13, 14).

If **Enter Password** displays, you must enter the correct password first.

Use the up and down arrow buttons to change the flashing digit of the password. Press the enter/save settings button to move to the next digit (left to right). The password is accepted when all four digits have been entered correctly and the enter/save settings button is pressed.

If *Login Error Invalid Password* displays, press the enter/save settings button to reenter the password.

You can now change the settings on the selected screen.

NOTE Once the password is entered, it will stay unlocked for 5 minutes so that you do not have to keep entering it. To save time, plan to make all your settings at one time.

If no password is desired, set the password to 0000. This password unlocks the controller so that anyone can change the settings without entering a password. To transfer the load, however, the *Are you sure?* screen appears.

Are you sure?

Once the correct password is entered, the controller stays unlocked for 5 minutes. During that time period if you press the transfer button, the **Are You Sure?** screen appears (instead of *Enter Password*). You can:

- press the enter/save button to confirm (commit) load transfer, or
- press the escape button to cancel the load transfer operation.

Voltage and Frequency Settings (Main Menu ⇨ Settings ⇨ Pick Up / Drop Out)

Unless otherwise specified on the order, the voltage and frequency settings are set at the factory to the default values. If a setting must be changed, follow the procedure below. Some settings may require a password.

NOTICE

Any indiscriminate change in these settings may affect the normal operation of the transfer switch. This change could allow the load circuits to remain connected to an inadequate source.

Description	Settings	Default Setting % of nominal	Adjustment Range increments of 1%	Display Screen (see below)
Normal Source Voltage	Dropout	85%	70 to 98%	N Volt DO
	Pickup	90%	85 to 100%	N Volt PU
	Over Voltage Trip*	off	off, 102 to 116%	N Volt OV
	Unbalance Dropout	20%	5 to 20%	N VUnb DO
	Unbalance Pickup	10%	3 to 18%	N VUNB PU
Emergency Source Voltage	Dropout	75%	70 to 98%	E Volt DO
	Pickup	90%	85 to 100	E Volt PU
	Over Voltage Trip*	off	off, 102 to 116%	E Volt OV
Normal Source Frequency	Dropout	85%	85 to 98%	N Freq DO
	Pickup	86%	86 to 100%	N Freq PU
	Over Frequency Trip*	off	off, 101 to 111%	N Freq OF
Emergency Source Frequency	Dropout	85%	85 to 98%	E Freq DO
	Pickup	95%	86 to 100%	E Freq PU
	Over Frequency Trip*	off	off, 101 to 111%	E Freq OF

* The Over Voltage and Over Frequency reset is fixed at 2% below the trip setting.

The voltage and frequency settings can be displayed and changed from the user interface. See the table above. Some settings may require a password.

1. On the **Main Menu** press the up or down arrow buttons to select **Settings**, then press the enter/save button to move to the **Settings** level of menus.
2. Press the up and down arrow buttons to highlight **Pickup / Dropout**, then press the enter/save settings button to move to the **PU/DO** display.
3. Then you can press the up and down arrow buttons to highlight the voltage and frequency settings screens. An overview explanation of the settings is listed below.

Description	Explanation
Normal Source Voltage	This screen shows dropout, pickup, and over-voltage trip settings for the normal source. They are in percentage of the nominal voltage and volts rms.
Emergency Source Voltage	This screen shows dropout, pickup, and over-voltage trip settings for the emergency source. They are in percentage of the nominal voltage and volts rms.
Normal Source Frequency	This screen shows dropout, pickup, and over-frequency trip settings for the normal source. They are in percentage of the nominal frequency and Hz.
Emergency Source Frequency	This screen shows dropout, pickup, and over-frequency trip settings for the emergency source. They are in percentage of the nominal frequency and Hz.
Normal Voltage Unbalance	This screen shows normal source voltage unbalance. It only appears if voltage unbalance is enabled and the transfer switch is three phase. The values are in percentage.

Timer Settings (Main Menu ⇒ Settings ⇒ Timers)

Unless otherwise specified on the order, the timer (time delay) settings are set at the factory to the default values. If a setting must be changed, carefully follow the procedure on the next page. Some settings may require a password.

NOTICE

Any indiscriminate change in these settings may affect the normal operation of the transfer switch. This change could allow the load circuits to remain connected to an inadequate source.

Feature	Timer	Default Setting	Adjustment Range 1 sec. increments	Display Screen (see next page)
1C ①	override momentary Normal source outages	3 seconds	0 to 6 sec see NOTICE below	N Fail (1C)
1F	override momentary Emergency source outages	4 seconds	0 to 6 sec see NOTICE below	E Fail (1F)
2B	transfer to Emergency (if Normal fails)	0	0 to 60 min 59 sec	N ➔ E N Fail (2B)
	transfer to Emergency (if just a test)	0	0 to 60 min 59 sec	N ➔ E Test (2B)
2E	engine cooldown	5 minutes	0 to 60 min 59 sec	Cool Down (2E)
3A	Retransfer to Normal (if Normal fails)	30 minutes	0 to 60 min 59 sec	E ➔ N N Fail (3A)
	Retransfer to Normal (if just a test) ⑦	30 seconds	0 to 9 hours 59 min 59 sec	E ➔ N Test (3A)
31F ②	Normal to Emergency pre-transfer signal	0	0 to 5 min 59 sec	N ➔ E PreX (31F)
31G ③	Emergency to Normal pre-transfer signal	0	0 to 5 min 59 sec	E ➔ N PreX (31G)
31M	Normal to Emergency post-transfer signal	0	0 to 5 min 59 sec	N ➔ E PosX (31M)
31N	Emergency to Normal post-transfer signal	0	0 to 5 min 59 sec	E ➔ N PosX (31N)
Inphase ④	inphase transfer	1.5 seconds	0 to 3 sec	Inphase
Load ⑤ ⑥ disconnect	delay transition transfer	3 seconds	0 to 5 min 59 sec	LD Disconnect
Fail accept maximum	failure to accept Emergency source alarm	3 seconds	0 to 6 sec see NOTICE below	E Accept Fail

① Standard adjustment up to 6 seconds (total power outage). See *NOTICE* below.

② To bypass Feature 31F if the Normal source fails, set bypass to **yes** in Features settings (page 15).

③ To bypass Feature 31G if the Emergency source fails, set bypass to **yes** in Features settings (page 15).

④ This timer appears only on the display for a 3ATS or 3NTS. Allows time for generator to stabilize before initiating inphase transfer.

⑤ This timer appears only on the display for a 3ADTS or 3NDTS.

⑥ To bypass load disconnect timer on source failures, set bypass to **yes** in Feature settings (page 15).

⑦ This timer is disabled on 3NTS and 3NDTS.

NOTICE

Feature 1C, 1F, and Fail accept maximum timers can be extended to 0 to 60 min 59 sec if an external 24 V dc power supply is included and the *External Battery* check box is selected (*General Settings, Other Parameters*, page 13). Accessory 1UP is available (page 32) if longer than 6 seconds is required.

Timer Settings continued (Main Menu ⇨ Settings ⇨ Timers)

The timer (time delay) settings can be displayed and changed from the user interface. See the table on the previous page. Some settings may require a password.

1. On the **Main Menu** press the up and down arrow buttons to highlight **Settings**, then press the enter/save button to move to the **Settings** menus.
2. Press the up and down arrow buttons to highlight **Timers**, then press the enter/save settings button to move to the list of timers.
3. Then you can press the up and down arrow buttons to highlight the timer settings displays. An overview explanation of the settings is listed below.

Display Screen	Explanation
N Fail (1C)	Momentary Normal source failure timer. It can be bypassed by pressing the transfer / bypass button.
E Fail (1F)	Momentary Emergency source failure timer.
N ➡ E N Fail (2B)	Normal to Emergency transfer timer (when normal source fails). It can be bypassed by pressing the transfer / bypass button.
N ➡ E Test (2B)	Normal to Emergency transfer timer (when transfer button is pressed).
Cool Down (2E)	Engine cool down timer does not run if the load was not transferred. It cannot be bypassed.
E ➡ N N Fail (3A)	Emergency to Normal retransfer timer (when normal source fails). It can be bypassed by pressing the transfer / bypass button.
E ➡ N Test (3A)	Emergency to Normal retransfer timer (when transfer button is pressed).
N ➡ E PreX (31F)	Normal to Emergency pre-transfer signal timer for external equipment. When this timer is running, the transfer can be aborted by pressing the transfer / bypass button. If the inphase feature is enabled, load transfer is prevented until the condition is met. To bypass Feature 31F if the Normal source fails, set bypass to yes in the Feature settings.
E ➡ N PreX (31G)	Emergency to Normal pre-transfer signal timer for external equipment. If the inphase feature is enabled, load transfer is prevented until the condition is met. To bypass Feature 31G if the Emergency source fails, set bypass to yes in the Feature settings.
N ➡ E PosX (31M)	Normal to Emergency post-transfer signal timer for external equipment. To bypass Feature 31M if the Emergency source fails, set it to yes <input checked="" type="checkbox"/> in the Features settings.
E ➡ N PosX (31N)	Emergency to Normal post-transfer signal timer for external equipment. To bypass Feature 31N if the Normal source fails, set it to yes <input checked="" type="checkbox"/> in the Features settings.
Inphase	Inphase timer precedes inphase transfers, if provided. Not available for 3ADTS, 3NDTS.
LD Disconnect	Load disconnect timer only for 3ADTS, 3NDTS delayed-transition transfer switch. The load is not connected to either source.
E Accept Fail	Failure to accept the Emergency source alarm timer turns on alert light when alarm expires

General Settings (Main Menu ⇨ Settings ⇨ General)

Unless otherwise specified on the order, the general settings are set at the factory to the default values.

Parameter	Sub Level	Default Setting	Adjustment Range	Display Screen (see next page)
Date & Time	Time	hh:mm:ss	01-23:00 - 59:00-59	hh:mm:ss
	Date	day mm/dd/yy	01-12 / 01-31 / 00-99	day mm/dd/yy
	Format	US	US ISO EU	mm/dd/yy yy/mm/dd dd/mm/yy
	Daylight Savings Time	Off	Off Apr/Oct Mar/Nov	Off Apr/Oct Mar/Nov
Communication – RS485 Port (optional Accessory 11BE)	Baud Rate	9600	115200 57600 38400 19200 9600 Off	115200 57600 38400 19200 9600 Off
	Device Address (Dev Addr)	1	1 - 247	1 - 247
	Protocol ①	AscoBusII	AscoBusII AscoBusI Modbus	AscoBusII AscoBusI Modbus
	Emulate Grp1 ②	no	yes <input checked="" type="checkbox"/> or no <input type="checkbox"/>	<input checked="" type="checkbox"/> or <input type="checkbox"/>
Display	Language	English	English Korean Chinese Turkish Russian German Italian Portuguese French Canadian French Spanish	English Korean Chinese Turkish Russian German Italian Portuguese French CAN French Spanish
	Contrast	15	1 to 20	1 to 20
	Backlight	On	On, Off, 1 to 59 min	On, Off, 1 to 59 min
	Volt Label	Vab/bc/ca	Vab/bc/ca Uab/bc/ca Uuv/vw/wu	Vab/bc/ca Uab/bc/ca Uuv/vw/wu
	Source 1/2 ③	no	yes <input checked="" type="checkbox"/> or no <input type="checkbox"/>	<input checked="" type="checkbox"/> or <input type="checkbox"/>
Other Parameters	Password	1111	a-z, A-Z, 0-9, 4 characters	* * * *
	External Battery	no	yes <input checked="" type="checkbox"/> or no <input type="checkbox"/>	<input checked="" type="checkbox"/> or <input type="checkbox"/>
	Current Sensing (accessory)	Off	Off, 1CT, 2CT, 3CT	Off, 1CT, 2CT, 3CT
	CT Ratio	400:5	50 - 4000:5	50 - 4000:5
	Clear Events (accessory)			
Common Alarms ⑤	TS on Emergency	no	yes <input checked="" type="checkbox"/> or no <input type="checkbox"/>	<input checked="" type="checkbox"/> or <input type="checkbox"/>
	Normal Failure	no	yes <input checked="" type="checkbox"/> or no <input type="checkbox"/>	<input checked="" type="checkbox"/> or <input type="checkbox"/>
	Emergency Failure	no	yes <input checked="" type="checkbox"/> or no <input type="checkbox"/>	<input checked="" type="checkbox"/> or <input type="checkbox"/>
	Loss E when on E	no	yes <input checked="" type="checkbox"/> or no <input type="checkbox"/>	<input checked="" type="checkbox"/> or <input type="checkbox"/>
	E Accept Fail	no	yes <input checked="" type="checkbox"/> or no <input type="checkbox"/>	<input checked="" type="checkbox"/> or <input type="checkbox"/>
	Engine Input	no	yes <input checked="" type="checkbox"/> or no <input type="checkbox"/>	<input checked="" type="checkbox"/> or <input type="checkbox"/>
Name & Location	Load Disconnected ④	no	yes <input checked="" type="checkbox"/> or no <input type="checkbox"/>	<input checked="" type="checkbox"/> or <input type="checkbox"/>
	Name		a-z, A-Z, 0-9, space, 20 char	
	Location		a-z, A-Z, 0-9, space, 20 char	

① For connectivity to the Group G Controller via Modbus, refer to 381339-310.

② When *Emulate Grp1* box is checked, baud rate is 9600 and protocol is AscoBusII.

③ *Source 1/2* only available for English language.

④ *Load Disconnected* appears only on the display for a 3ADTS, 3NDTS.

⑤ The alert light also turns on for common alarms

General Settings continued (Main Menu ⇨ Settings ⇨ General)

The general settings can be displayed and changed from the user interface. See the table on the previous page. If a setting must be changed follow the procedure below. Some settings may require a password.

1. From the **Main Menu** press the up and down arrow buttons to highlight **Settings**, then press the enter/save button to move to the **Settings** menus.
2. Press the up and down arrow buttons to highlight **General**, then press the enter/save settings button to move to the list of general settings.
3. Then you can press the up and down arrow buttons to highlight the general settings displays. An overview explanation of the settings is listed below.

Parameter	Explanation
Date & Time	This screen allows the user to change the time, date, date format, and daylight savings time.
Communication (Accessory 11BE)	If optional Accessory 11BE was ordered, this screen allows the user to configure the RS485 communication port. The baud rate can be set off, 9600 – 115200. The address can be set 1 to 247. See the Appendix for setting DIP switches S7 and S8. S7 sets the terminating resistor; S8 sets 2 wire or 4 wire.
Display	This screen selects the language for messages (English is the default language). Screen contrast can be set. Three voltage phase labels can be set. Source 1/2 (S1/S2) can be set instead of Normal and Emergency (N/E).
Other Parameters	This screen allows the user to change the password (default password is 1111). There is a setting for an external battery (if connected) for Feature 1C or 1F extended time range. If the optional current sensing module is installed, current sensing should be set for single phase or three phase. The current transformer (CT) ratio should be set for the ampere size of the transfer switch (refer to the label on the CT used). See current transformer WARNING below. All events can be cleared from the controller, if desired.
Common Alarms	This screen shows selected alarm conditions. If enabled, the alarm condition will turn on the alert indicator and deenergize the configured common alarm output relays (OP1, and optional OP2, OP3) for external monitoring.
	TS on Emergency-active when TS is connected to the Emergency source
	Normal Failure-active when the power on the Normal source does not meet acceptability requirements
	Emergency Failure-active when the power on the Emergency source does not meet acceptability requirements
	Loss E when on E-active when there is a loss of Emergency when connected to Emergency.
	E Accept Fail-active when Emergency fails to become acceptable before the timer expires
	Engine Input-(only available when Accessory 30 is not being used) active when the external alarm signal to the engine input is active
	Load Disconnect-(for Delayed Transition Switches only) active when the TS is disconnected from both sources
Name & Location	This screen allows the user to enter a name and location of the Transfer Switch (maximum 20 alphanumeric characters each). If communication is used, the name and location is exported (for ASCO bus II protocol name has an 8 character limit). The name & location parameter is not available (disabled) if English language is not selected.



Never leave an open secondary circuit of a current transformer. Dangerous voltage can cause shocks, burns, and/or death. When disconnected always install a shorting jumper between the current transformer terminals.

Features Settings (Main Menu ⇨ Settings ⇨ Features)

Unless otherwise specified on the order, the features settings are set at the factory to the default values. If a setting must be changed follow the procedure on the next page. Some settings may require a password.

NOTICE

Any indiscriminate change in these settings may affect the normal operation of the transfer switch. This change could allow the load circuits to remain connected to an inadequate source.

Feature	Default Setting	Adjustment Range	Display Screen (see next page)
Bypass Normal to Emergency transfer Feature 31 upon connected source failure	no	yes <input checked="" type="checkbox"/> or no <input type="checkbox"/>	BP N ➔ E F31 N Fail
Bypass Emergency to Normal transfer Feature 31 upon connected source failure	no	yes <input checked="" type="checkbox"/> or no <input type="checkbox"/>	BP E ➔ N F31 E Fail
Commit to transfer	no	yes <input checked="" type="checkbox"/> or no <input type="checkbox"/>	Commit Transfer
Bypass delayed-transition transfer upon a source failure ①	no	yes <input checked="" type="checkbox"/> or no <input type="checkbox"/>	BP DTTS Src Fail
Inphase monitor enable ②	no	yes <input checked="" type="checkbox"/> or no <input type="checkbox"/>	Inphase On
Load Shed Inphase enable ②	no	yes <input checked="" type="checkbox"/> or no <input type="checkbox"/>	Load Shed Inphase
Fail Accept Timer	no	yes <input checked="" type="checkbox"/> or no <input type="checkbox"/>	Fail Accept Timer
External Feature 6B	no	yes <input checked="" type="checkbox"/> or no <input type="checkbox"/>	Ext. Feature 6B
External Feature 17 ③	no	yes <input checked="" type="checkbox"/> or no <input type="checkbox"/>	Ext. Feature 17
Feature 6DL enable	no	yes <input checked="" type="checkbox"/> or no <input type="checkbox"/>	Feature 6DL
Serial Feature 17 enable	no	yes <input checked="" type="checkbox"/> or no <input type="checkbox"/>	Serial Feature 17
Normal Voltage Unbalance enable	no	yes <input checked="" type="checkbox"/> or no <input type="checkbox"/>	Volt Unbalance
Emergency Voltage Unbalance enable⑦	no	yes <input checked="" type="checkbox"/> or no <input type="checkbox"/>	Volt Unbalance
Phase Rotation⑦	disabled	Disabled, ABC or CBA	Phase Rotation
Controller Output contact OP1 (select one)	yes	yes <input checked="" type="checkbox"/> or no <input type="checkbox"/>	Feature 31
	no	yes <input checked="" type="checkbox"/> or no <input type="checkbox"/>	Common Alarm ④
	no	yes <input checked="" type="checkbox"/> or no <input type="checkbox"/>	NR2
	no	yes <input checked="" type="checkbox"/> or no <input type="checkbox"/>	Not In Auto
Relay Expansion Module ④ ⑤ Output contact OP2 (select one)	no	yes <input checked="" type="checkbox"/> or no <input type="checkbox"/>	Feature 31
	yes	yes <input checked="" type="checkbox"/> or no <input type="checkbox"/>	Common Alarm
	no	yes <input checked="" type="checkbox"/> or no <input type="checkbox"/>	NR2
	no	yes <input checked="" type="checkbox"/> or no <input type="checkbox"/>	Not In Auto
	no	yes <input checked="" type="checkbox"/> or no <input type="checkbox"/>	1G
Relay Expansion Module ④ ⑤ Output contact OP3 (select one)	no	yes <input checked="" type="checkbox"/> or no <input type="checkbox"/>	Feature 31
	no	yes <input checked="" type="checkbox"/> or no <input type="checkbox"/>	Common Alarm
	no	yes <input checked="" type="checkbox"/> or no <input type="checkbox"/>	NR2
	yes	yes <input checked="" type="checkbox"/> or no <input type="checkbox"/>	Not In Auto
Manual DTTS ⑥ Load Disconnect Recovery Mode	no	yes <input checked="" type="checkbox"/> or no <input type="checkbox"/>	Manual
	yes	yes <input checked="" type="checkbox"/> or no <input type="checkbox"/>	Auto

① This feature appears only on the display for a 3ADTS.

② This feature appears only on the display for a 3ATS.

③ This feature appears only on the display for a 3ATS or 3ADTS, not on a 3NTS or 3NDTS.

④ The Controller Output contact OP1 can be set to operate with a Common Alarm only if Accessory 11BE is ordered. See page 31.

⑤ The Relay Expansion Module is optional Accessory 18RX for 3ATS and 3NTS. It is included with a 3ADTS and 3NDTS. See page 32.

⑥ This feature appears only on the display for a 3NDTS.

⑦ This feature only for 3 phase systems with optional 11BE bundle.

Features Settings continued (Main Menu ⇨ Settings ⇨ Features)

The features settings can be displayed and changed from the user interface. See the table on the previous page. Some settings may require a password.

1. From the **Main Menu** press the up and down arrow buttons to highlight **Settings**, then press the enter/save button to move to the **Settings** menus.
2. Press the up and down arrow buttons to highlight **Features**, then press the enter/save settings button to move to the list of features.
3. Then you can press the up and down arrow buttons to highlight the feature settings displays. An overview explanation of the settings is listed below.

Display Screen	Explanation
BP N ➡ E F31 N Fail	This display shows the setting for bypass Normal to Emergency transfer Feature 31 if the connected source fails. If set to yes, there is no delay.
BP E ➡ N F31 E Fail	This display shows the setting for bypass Emergency to Normal transfer Feature 31 if the connected source fails. If set to yes, there is no delay.
BP DTTS Src Fail	This display appears only for 3ADTS. It shows the setting for bypassing delayed-transition transfer upon a source failure. If set to yes, there is no delay.
Commit Transfer	This setting affects the transfer sequence as follows: Enabled (yes) - If Normal fails the controller continues transfer sequence to emergency even if Normal returns before Emergency becomes acceptable. Disabled (no) - If Normal fails, the controller cancels the transfer sequence to emergency if Normal returns before Emergency becomes acceptable.
Inphase On	This display appears only for 3ATS, 3NTS. It shows the status of inphase monitor. If it is on, load transfer is delayed until sources are inphase.
Load Shed Inphase	This display appears only for 3ATS. It shows the status of inphase monitor for load shed. If it is on, load transfer is delayed until sources are inphase.
Fail Accept Timer	This display shows the failure to accept Emergency source timer setting. If set to yes, the alert light will turn on after this timer runs out.
Ext. Feature 6B	This display shows the enable setting for external Feature 6B (override switch to manually bypass time delay on retransfer to normal source).
Ext. Feature 17	This display shows the enable setting for external Feature 17 (remote contact which opens to signal ATS to transfer to emergency).
Feature 6DL	This display shows the enable setting for Feature 6DL (retransfer to normal mode). If enabled, manual retransfer is required (indicated by alert light) by pressing the Transfer button. Automatic retransfer occurs if the emergency source fails.
Serial Feature 17	This display shows the enable setting for serial communication Feature 17 (remote signal to ATS to transfer to emergency or normal).
Voltage Unbalance	This display shows the enable setting for voltage unbalance (3 phase TS only). If enabled, voltage unbalance appears on the metering screen.
Phase Rotation Monitor	This option makes the acceptability of the sources also dependent upon their matching the reference phase rotation. It will also display the presently detected rotation of each source on the metering screen. (3 phase TS with 11BE only)
Output OP1, OP2, OP3	This display shows the settings for output contacts OP1, OP2, and OP3. OP1 is in the Group G controller. OP2 and OP3 are in the Relay Expansion Module. This module is included in 3DTS and 3NDTS; it is an optional accessory on 3ATS and 3NTS. Feature 1G is available on OP2. See page 32.
Manual DTTS Load Disconnect Recovery Mode	This display only appears for 3NDTS. It shows the setting for load disconnect recovery. It is normally set to Auto.

Engine Exercisers (Main Menu ⇒ Settings ⇒ Engine Exerciser)

These timers periodically exercise the emergency engine-generator. They can be set to exercise with or without load transfer, or they can be completely disabled. The engine-generator should be exercised under load once a week for a minimum time period of 20 minutes, or follow the recommendations of the engine-generator set manufacturer.

Unless otherwise specified on the order, the engine exerciser settings are set at the factory to the default values. If a setting must be changed follow the procedure on the next page. Some settings may require a password.

NOTICE

Any indiscriminate change in these settings may affect the normal operation of the transfer switch. This change could allow the load circuits to remain connected to an inadequate source.

Standard Exerciser

The standard built-in exerciser provides a once a week (or two week) 20 minute exercise period.

Exercise Parameter	Default Setting	Adjustment Range	Display Screen (see next page)
Enable	no	no <input type="checkbox"/> or yes <input checked="" type="checkbox"/>	Enable <input type="checkbox"/>
With load	no	no <input type="checkbox"/> or yes <input checked="" type="checkbox"/>	With Load <input type="checkbox"/>
Interval	weekly	Weekly or Bi-Weekly	Interval Weekly
Start day	Sun	Sun, Mon, Tue, Wed, Thu, Fri, Sat	Day of Week Sun
Start time	00:00	0 to 23 h, 0 to 59 m (hh:mm)	Time 00:00
Duration	20	not adjustable	

Programmable Exerciser (part of optional Accessory 11BE)

The programmable exerciser provides seven programmable exercise periods. They can be set for once a week (all), alternate weeks (1st, 2nd, 3rd, 4th, 5th week), and each with an adjustable start and exercise period.

Exercise Parameter	Default Setting	Adjustment Range	Display Screen (see next page)
Program number	1	1 to 7	Program No 1
Enable	no <input type="checkbox"/>	no <input type="checkbox"/> or yes <input checked="" type="checkbox"/>	Enable <input type="checkbox"/>
With load	no <input type="checkbox"/>	no <input type="checkbox"/> or yes <input checked="" type="checkbox"/>	With Load <input type="checkbox"/>
Interval / Start week	All	All, Alt (alternate), 1 st , 2 nd , 3 rd , 4 th , 5 th	Start Week All
Start day	Sun	Sun, Mon, Tue, Wed, Thu, Fri, Sat	Day of Week Sun
Start time	00:00	0 to 23 h, 0 to 59 m (hh:mm)	Time 00:00
Duration	00:00	0 to 23 h, 0 to 59 m (hh:mm)	Duration 00:00

Engine Exercisers continued (Main Menu ⇨ Settings ⇨ Engine Exerciser)

The engine exerciser settings can be displayed and changed from the user interface. See the table on the previous page. Some settings may require a password.

1. From the **Main Menu** press the up and down arrow buttons to highlight **Settings**, then press the enter/save button to move to the **Settings** menus.
2. Press the up and down arrow buttons to highlight **Engine Exerciser**, then press the enter/save settings button to move to the *Engine Exerciser* screen.
3. Then you can press the up and down arrow buttons to highlight the engine exerciser settings displays. An overview explanation of the settings is listed below.

Exercise Parameter	Explanation
Program number (Accessory 11BE)	Up to seven independent engine exercise routines can be set. Each routine functions in the same manner. Six parameters need to be configured for <u>each</u> routine (Program No 1, 2, 3, 4, 5, 6, 7 – not all have to be used)
Enable	Enable (turn on) or disable (turn off) the exercise routine. <input checked="" type="checkbox"/> Enables the exerciser. <input type="checkbox"/> Disables the exerciser.
With load	Exercise with or without load transfer. <input checked="" type="checkbox"/> The load will be transferred to Emergency. <input type="checkbox"/> No load transfer. The load will not be transferred to Emergency.
Interval (standard exerciser)	Exercise week: Weekly or Bi-weekly.
Start week (Accessory 11BE exerciser)	Exercise week: All, Alternate, 1st, 2nd, 3rd, 4th, or 5th week
Start day	Exercise day: Sun, Mon, Tue, Wed, Thu, Fri, Sat
Start time	Exercise start time: hh:mm 0-23 hour 0-59 minute
Duration (standard exerciser)	Exercise run time (length of time) that the generator will run. 20 minutes (not adjustable).
Duration (Accessory 11BE exerciser)	Exercise run time (length of time) that the generator will run. hh:mm 0-23 hour 0-59 minute

View Event Log Accessory 11BE, page 31 (Main Menu ⇨ Event Log)

Event Log is used to view events; use the up and down buttons to navigate the event list.

If optional Accessory 11BE was ordered, the controller event log can be viewed from the user interface.

1. From the **Main Menu** screen press the up and down arrow buttons to highlight **Event Log**, then press the enter/save button to move to the **Event Log**.
2. Press the up and down arrow buttons to scroll through the **Event Log**.

Logged Events

The display shows the last 300 events. Each event displays shows the event number (1 is the most recent, 300 is the oldest), the time and date of the event, the event type, and the cause or reason (if applicable) under the event type.

Refer to **Appendix (page 35)** for a list of the event types recorded.

Refer to **Appendix (page 36)** for a list of the event causes.

View Statistics (Main Menu ⇨ Statistics)

Statistics is used to view transfer switch (TS) history and statistics.

The statistics log can be viewed from the user interface.

1. From the **Main Menu** display press the up and down arrow buttons to highlight **Statistics**, then press the enter/save button to view the list.
2. Press the up and down arrow buttons to scroll through the **Statistics**.

Refer to **Appendix (page 35)** for a list of the statistics kept.

View About (Main Menu ⇨ About)

About is used to view controller information; use the up and down buttons to navigate the *About* list.

The *About* screen can be viewed from the user interface.

1. From the **Main Menu** screen press the up and down arrow buttons to highlight **About**, then press the enter/save button to view the **About** screen.
2. Press the up and down arrow buttons to scroll through the **About** screens.

About screens

The display shows the nominal voltage and frequency, the transfer switch ampere size, the type of transfer switch, the transfer switch name, location, the software version, bootloader version, and the serial number.

Screen Messages and their Meanings

The following messages (in alphabetical order) can appear on the controller display:

Screen Message	Meaning or Explanation	Refer to Pages
Access denied Option not installed Press the escape key to cancel.	If optional Accessory 11BE was not ordered, this message displays if Acc. 11BE features are selected. Press escape key to return to previous screen.	2
Are you sure?	This may appear when you press the transfer button.	9, 22
Emergency → Normal Timer	The emergency to normal load transfer time delay (Feature 3A) is running. The time remaining is shown.	11, 12
Engine Exerciser / With Load	The engine exerciser is running the engine-generator set with load (transfer switch transfers load to generator).	17, 18
Engine Exerciser / Without Load	The engine exerciser is running the engine-generator set without load (the transfer switch does <u>not</u> transfer the load to the generator).	17, 18
Engine Cooldown Timer	The engine-generator set unloaded cooldown time delay (Feature 2E) is running. The time remaining is shown.	11, 12
Fail Acquire E	Controller is unable to accept the emergency source within the time specified.	13, 14
Feature 6DL Active	Automatic load retransfer to normal source is inhibited.	15, 16
Invalid Password	An incorrect password has been entered.	9
Load Disconnect	The load is disconnected. (3ADTS, 3NDTS)	
Load Disconnect Timer	The load disconnect time delay is running. The time remaining is shown. (3ADTS, 3NDTS)	11, 12
Load on Emergency	The load is connected to the emergency source.	
Load on Normal	The load is connected to the normal source.	
Load Shed / From Emergency	Load shed from emergency, Acc. 30. (3ATS, 3ADTS)	32
Load Shed / From Normal	Load shed from normal, Acc. 30. (3ATS, 3ADTS)	32
Loss E When on E	The emergency source has failed with the load connected to emergency.	13, 14
Manual Transfer	In the manual transfer mode.	
Manual Transfer Enabled	The transfer switch is in the manual mode.	
No Active Alarms	There are no active alarms.	3
Normal → Emergency Timer	The normal to emergency load transfer time delay (Feature 2B) is running. The time remaining is shown.	11, 12
Normal Fail Timer	The normal source failure time delay (Feature 1C) is running. The time remaining is shown.	11, 12
Normal Failed / Under Voltage	The normal source is not acceptable.	20
Normal OK	The normal source is accepted.	20
Post Transfer Timer	The post-transfer time delay (Feature 31M or 31N) is running. The time remaining is shown.	11, 12
Pre Transfer Timer	The pre-transfer time delay (Feature 31F or 31G) is running. The time remaining is shown.	11, 12
Sources Not Acceptable	The controller has powered up and has recognized an error condition (both sources are not accepted).	See HELP in INDEX
Switch Position Unknown	The controller has powered up and has recognized an error condition (cannot determine switch position).	See HELP in INDEX
Test Mode / Test Circuit 5	Occurs briefly during a transfer test.	Installation Manual
Test Mode / Test Circuit 17	Test circuit Feature 17 is active (remote test).	15, 16
Time to Run	The engine exerciser time remaining is shown.	









Screen Messages and their Meanings (continued)

The following messages (in alphabetical order) can appear on the controller display:

Screen Message	Meaning or Explanation	Refer to Pages
Transfer → Emergency Inhibited	Load transfer to emergency source is inhibited.	
Waiting for Emergency Acceptable	The controller is waiting for the emergency source to become acceptable so that it can continue in the transfer sequence.	20
Waiting for Inphase	The controller is waiting for the sources to come inphase so that it can make an inphase load transfer. The phase angle and frequency difference are also displayed. This message will be displayed until the sources come inphase. (3ATS, 3NTS)	20
Waiting for Inphase Timer	The inphase transfer timer is running. (3ATS,3NTS)	11, 12
Waiting for Retransfer	The controller is waiting for the transfer button to be pressed. (3NTS, 3NDTS)	7, 8, 28, 30

Control Messages and their Meanings

The following control messages (in alphabetical order) can appear on the controller display:

Control Message	Meaning or Explanation	Refer to Pages
Enter Password	A password is required to proceed further in the change process. Enter the correct password to continue or press the escape button.	2, 4, 9
Press  Abort Transfer 3ADTS & 3NDTS	Press the transfer button to stop an impending load transfer when any of these screens appear: <ul style="list-style-type: none"> • normal OK, waiting for inphase timer • normal OK, running pre-transfer timer • normal failed, waiting for emergency • test mode & load shed pre transfer timer • engine exerciser with load pre transfer timer • normal → emergency load disconnect timer • emergency → normal load disconnect timer 	10, 11
Press  Bypass Timer	Press the transfer button to cancel a running time delay when any of these screens appear: <ul style="list-style-type: none"> • normal OK, emergency → normal timer • normal failed, normal fail timer • normal failed, normal → emergency timer • normal failed, emergency → normal timer • engine exerciser time to run timer • test mode & load shed, normal → emergency timer • test mode & load shed, emergency → normal timer 	
Press  Re-Transfer 3NTS, 3NDTS	Press the transfer button to retransfer the load to normal when any of these screens appear: <ul style="list-style-type: none"> • normal failed, waiting for re-transfer • Feature 17 transfer, waiting for re-transfer • Feature 6DL active, waiting for re-transfer • manual transfer, waiting for re-transfer 	
Press  Test Transfer (3ATS, 3ADTS)	Press the transfer button to perform a test load transfer when any of these screens appear: <ul style="list-style-type: none"> • normal OK, load on normal, waiting for retransfer signal, engine cooldown timer • load shed, load on normal, normal → emergency timer, engine cooldown timer 	Transfer Switch Installation Manual
Press  Transfer (3NTS, 3NDTS)	Press the transfer button to perform a test load transfer when any of these screens appear: <ul style="list-style-type: none"> • normal OK, load on normal 	Transfer Switch Installation Manual
Press  to acknowledge alarms	The display freezes if an active alarm needs to be acknowledged. Note it, then press the enter button.	3
Press  to Test (3ATS, 3ADTS)	Press the transfer button to confirm load transfer.	3
Press  to Transfer (3NTS, 3NDTS)	Press the transfer button to confirm load transfer.	3
Press  to Cancel	Press the escape button to return to previous screen.	2, 4, 9

Open-Transition Automatic Transfer (3ATS)

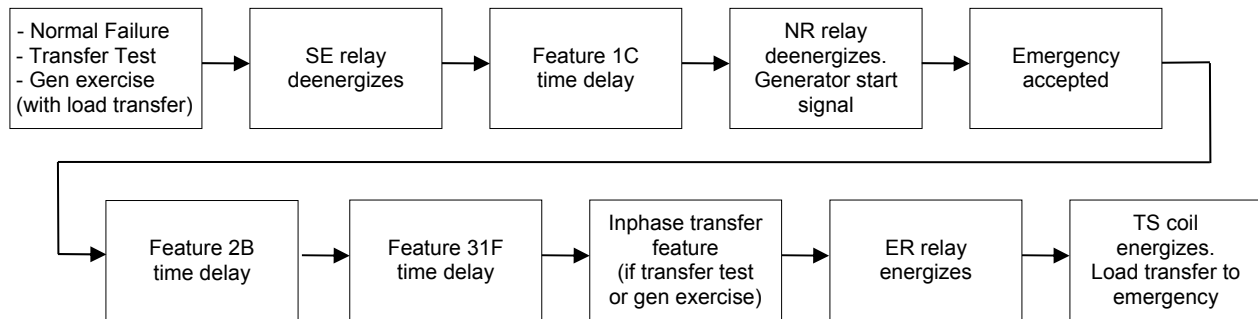

Load Transfer to Emergency

The sequence for load transfer to the emergency source begins automatically when the controller detects a normal source failure, a transfer test signal (either local or remote), a remote transfer to emergency signal, or a generator exercise (with load transfer).

Normal Source Failure. The Normal source is considered unacceptable when any one of four voltage or frequency conditions occur (see page 3).

Transfer Test Signal. The test transfer signal can be from the transfer button, the engine-generator exerciser, or via the optional serial port (Accessory 11BE).

The controller begins the load transfer sequence by de-energizing the SE relay and starting the Feature 1C time delay. Feature 1C time delay on engine starting prevents nuisance starting of the engine-generator set and load transfer to emergency due to momentary failures of the normal source. If the normal source is restored (voltage returns above the dropout point) while Feature 1C time delay is running, the SE relay is re-energized and the transfer sequence is terminated. (For transfer test the Feature 1C time delay is bypassed.)

Engine Start Signal. When the Feature 1C time delay ends, the controller de-energizes the NR relay which signals the engine-generator to start. The controller monitors the emergency source, waiting for it to become acceptable. Usually about 10 seconds elapse from dropout of the NR relay to acceptance of the emergency source. This interval occurs because the engine-generator must crank, start, and run up to nominal pickup points. If the emergency source is available immediately, the controller will accept it as soon as the NR relay drops out.

When the emergency source becomes acceptable, the controller starts the Feature 2B time delay on transfer to emergency (if desired). Feature 2B time delay allows the emergency source to stabilize before load transfer. If the emergency source fails while Feature 2B time delay is running, the controller again waits for the emergency source to become acceptable again and restarts Feature 2B.

At the conclusion of the Feature 2B time delay, the controller is ready to transfer the load to emergency. If enabled, Feature 31F time delay will run prior to transfer and the Feature 31 output will be active while the time delay runs. Also, if the inphase transfer feature (for motor loads) is enabled, the controller will inhibit transfer until the sources are inphase.

Load Transfer. To transfer the load to the emergency source the controller energizes ER relay. The transfer switch TS coil energizes, and all transfer switch contacts (mains, controls, auxiliaries) reverse position. Transfer switch is now supplying the load from emergency source. Feature 1F time delay ignores a momentary voltage drop of the emergency source when load is added to the generator.

If enabled, Feature 31M time delay will run after the transfer and the Feature 31 output will be active while the time delay runs.

Open-Transition Automatic Transfer (3ATS) continued

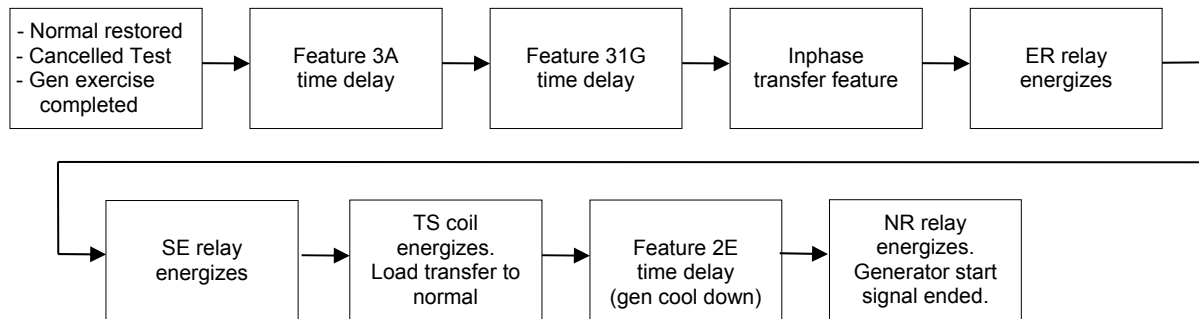

Load Retransfer to Normal

The sequence for load retransfer to the normal source begins automatically when the controller detects a restored normal source, a cancelled transfer test signal (local or remote), a cancelled remote transfer to emergency signal, or a completed generator exercise (with load transfer).

Normal Source Restoration. The Normal source is considered acceptable again when all four voltage and frequency conditions occur (see page 3).

Cancel Transfer Test. Removal of the test transfer signal can be by pressing the transfer button again, ending a remote test, complete engine-generator exercise period, or via the optional serial port (Accessory 11BE).

The controller begins the load retransfer sequence by starting the Feature 3A time delay. Feature 3A time delay on retransfer to normal allows the normal source to stabilize. If the normal source fails while the Feature 3A time delay is running, the controller waits for the normal source again to become acceptable and restarts the Feature 3A time delay. If the emergency source fails while Feature 3A is running, the controller bypasses the time delay for immediate load transfer. To bypass Feature 3A time delay press the transfer button (bypass timer).

At the conclusion of the Feature 3A time delay, the controller is ready to transfer the load to normal. If enabled, Feature 31G time delay will run prior to retransfer and the Feature 31 output will be active while the time delay runs. Also, if the inphase transfer feature is enabled, the controller will prevent transfer until the sources are inphase.

Load Retransfer. To retransfer the load to the normal source the controller de-energizes ER relay and energizes SE relay. The transfer switch TS coil energizes, and all transfer switch contacts (mains, controls, auxiliaries) reverse position. The transfer switch is now supplying the load from the normal source again.

Engine Cooldown and Stop. After load retransfer to the normal source, the controller starts Feature 2E time delay. Feature 2E time delay provides an unloaded cooldown running period for the engine-generator. At the end of the time delay, the controller energizes the NR relay and the engine-generator is signaled to shutdown.

Delayed-Transition Automatic Transfer (3ADTS)

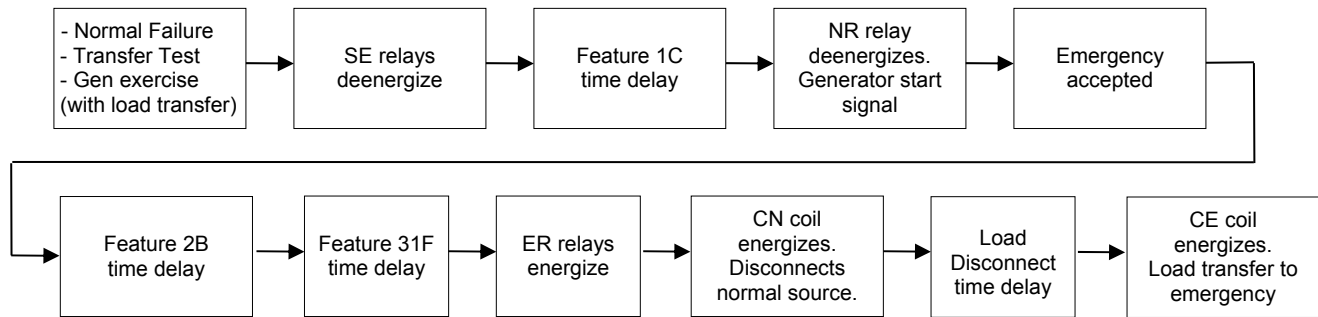

Load Transfer to Emergency

The sequence for load transfer to the emergency source begins automatically when the controller detects a normal source failure, a transfer test signal (either local or remote), a remote transfer to emergency signal, or a generator exercise (with load transfer).

Normal Source Failure. The Normal source is considered unacceptable when any one of four voltage or frequency conditions occur (see page 3).

Transfer Test Signal. The test transfer signal can be from the transfer button, the engine-generator exerciser, or via the optional serial port (Accessory 11BE). The controller begins the load transfer sequence by de-energizing the SE relays and starting the Feature 1C time delay. Feature 1C time delay on engine starting prevents nuisance starting of the engine-generator set and load transfer to emergency due to momentary failures of the normal source. If the normal source is restored (voltage returns above the dropout point) while Feature 1C time delay is running, the SE relays is re-energized and the transfer sequence is terminated. (For transfer test the Feature 1C time delay is bypassed.)

Engine Start Signal. When the Feature 1C time delay ends, the controller de-energizes the NR relay which signals the engine-generator to start. The controller monitors the emergency source, waiting for it to become acceptable. Usually about 10 seconds elapse from dropout of the NR relay to acceptance of the emergency source. This interval occurs because the engine-generator must crank, start, and run up to nominal pickup points. If the emergency source is available immediately, the controller will accept it as soon as the NR relay drops out.

When the emergency source becomes acceptable, the controller starts the Feature 2B time delay on transfer to emergency (if desired). Feature 2B time delay allows the emergency source to stabilize before load transfer. If the emergency source fails while Feature 2B time delay is running, the controller again waits for the emergency source to become acceptable again and restarts Feature 2B.

At the conclusion of the Feature 2B time delay, the controller is ready to transfer the load to emergency. If enabled, Feature 31F time delay will run prior to transfer and the Feature 31 output will be active while the time delay runs.

Load Transfer. To transfer the load to the emergency source in a delayed-transition mode the controller energizes the ER relays. The transfer switch CN coil energizes and opens the CN transfer switch main contacts. The load is disconnected from both sources. The load disconnect time delay starts. When this time delay ends, the controller energizes the ER relays. The transfer switch CE coil energizes and closes the CE transfer switch main contacts. Transfer switch is now supplying the load from emergency source. Feature 1F time delay ignores a momentary voltage drop of the emergency source when load is added to the generator.

Delayed-Transition Automatic Transfer (3ADTS) continued

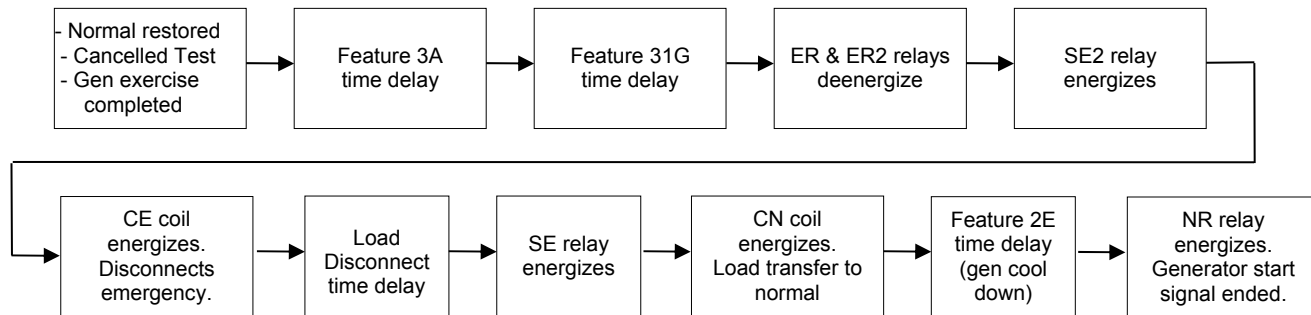

Load Retransfer to Normal

The sequence for load retransfer to the normal source begins automatically when the controller detects a restored normal source or a cancelled transfer test signal (local or remote), a cancelled remote transfer to emergency signal, or a completed generator exercise (with load transfer).

Normal Source Restoration. The Normal source is considered acceptable again when all four voltage and frequency conditions occur (see page 3).

Cancel Transfer Test. Removal of the test transfer signal can be by pressing the transfer button again, ending a remote test, complete engine-generator exercise period, or via the optional serial port (Accessory 11BE).

The controller begins the load retransfer sequence by starting the Feature 3A time delay. Feature 3A time delay on retransfer to normal allows the normal source to stabilize. If the normal source fails while the Feature 3A time delay is running, the controller waits for the normal source again to become acceptable and restarts the Feature 3A time delay. If the emergency source fails while Feature 3A is running, the controller bypasses the time delay for immediate load transfer. To bypass Feature 3A time delay press the transfer test button (bypass timer).

At the conclusion of the Feature 3A time delay, the controller is ready to transfer the load to normal. If enabled, Feature 31G time delay will run prior to retransfer and the Feature 31 output will be active while the time delay runs.

Load Retransfer. To retransfer the load to the normal source in a delayed-transition mode the controller de-energizes the ER and ER2 relay and energizes the SE2 relay. The transfer switch CE coil energizes and opens the CE transfer switch main contacts. The load is disconnected from both sources. The load disconnect time delay starts. When this time delay ends the controller energizes the SE relay. The transfer switch CN coil energizes and closes the CN transfer switch main contacts. The transfer switch is now supplying the load from the normal source again.

Engine Cooldown and Stop. After load retransfer to the normal source, the controller starts Feature 2E time delay. Feature 2E time delay provides an unloaded cooldown running period for the engine-generator. At the end of the time delay, the controller energizes the NR relay and the engine-generator is signaled to shutdown.

Open-Transition Non-Automatic Transfer (3NTS)

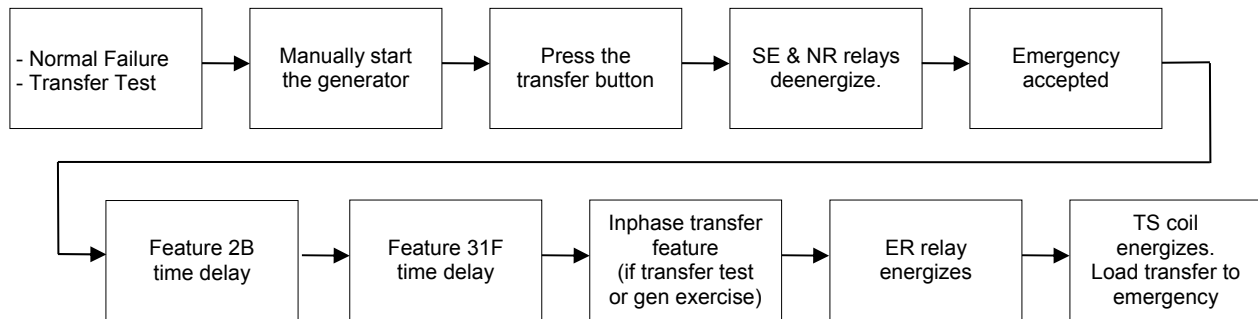

Load Transfer to Emergency

The transfer switch does not transfer the electrical load automatically. The generator is not started automatically. The sequence for load transfer to the emergency source begins when the controller detects a normal source failure, emergency source available, and a transfer test signal (either local or remote), a remote transfer to emergency signal.

Normal Source Failure. The Normal source is considered unacceptable when any one of four voltage or frequency conditions occur (see page 3).

Manually Start the Generator. If the Normal source has failed or to perform a transfer test, manually start the engine-generator first.

Transfer Test Signal. The test transfer signal can be from the transfer button or via the optional serial port (Accessory 11BE). The controller de-energizes the SE relay and NR relay. The controller monitors the emergency source, waiting for it to become acceptable.

When the emergency source becomes acceptable, the controller starts the Feature 2B time delay on transfer to emergency (if desired). Feature 2B time delay allows the emergency source to stabilize before load transfer. If the emergency source fails while Feature 2B time delay is running, the controller again waits for the emergency source to become acceptable again and restarts Feature 2B.

At the conclusion of the Feature 2B time delay, the controller is ready to transfer the load to emergency. If enabled, Feature 31F time delay will run prior to transfer and the Feature 31 output will be active while the time delay runs. Also, if the inphase transfer feature (for motor loads) is enabled, the controller will prevent transfer until the sources are inphase.

Load Transfer. To transfer the load to the emergency source the controller energizes ER relay. The transfer switch TS coil energizes, and all transfer switch contacts (mains, controls, auxiliaries) reverse position. Transfer switch is now supplying the load from emergency source.

If enabled, Feature 31M time delay will run after the transfer and the Feature 31 output will be active while the time delay runs.

Open-Transition Non-Automatic Transfer (3NTS) continued

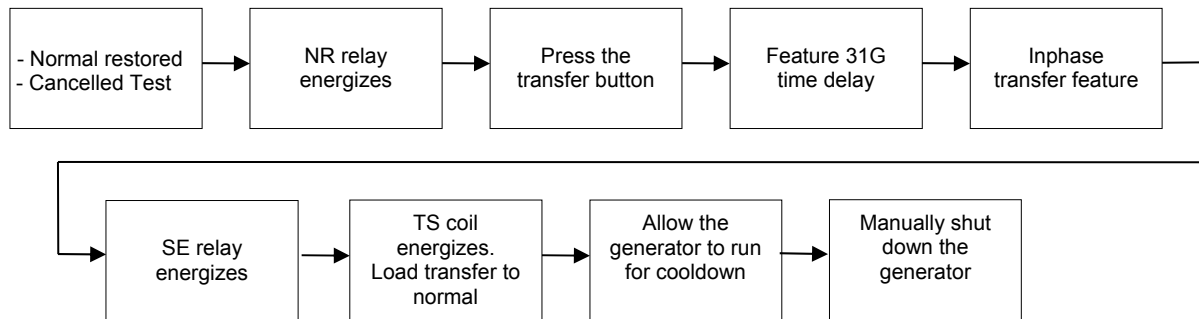

Load Retransfer to Normal

The transfer switch does not retransfer the electrical load automatically. The generator is not stopped automatically. The sequence for load retransfer to the normal source begins when the transfer button is pressed again. A password may need to be entered first.

Normal Source Restoration. The Normal source is considered acceptable again when all four voltage and frequency conditions occur (see page 3).

Transfer Test Signal. The test transfer signal can be from the transfer button or via the optional serial port (Accessory 11BE). The controller monitors the normal source, waiting for it to become acceptable. The controller energizes the NR relay. The controller is ready to transfer the load to normal. If enabled, Feature 31G time delay will run prior to retransfer and the Feature 31 output will be active while the time delay runs. Also, if the inphase transfer feature is enabled, the controller will prevent transfer until the sources are inphase.

Load Retransfer. To retransfer the load to the normal source the controller de-energizes ER relay and energizes SE relay. The transfer switch TS coil energizes, and all transfer switch contacts (mains, controls, auxiliaries) reverse position. The transfer switch is now supplying the load from the normal source again.

Engine Cooldown and Stop. After load retransfer to the normal source, allow the generator to run for a cool down period. Then manually shut down the engine-generator.

Delayed-Transition Non-Automatic Transfer (3NDS)

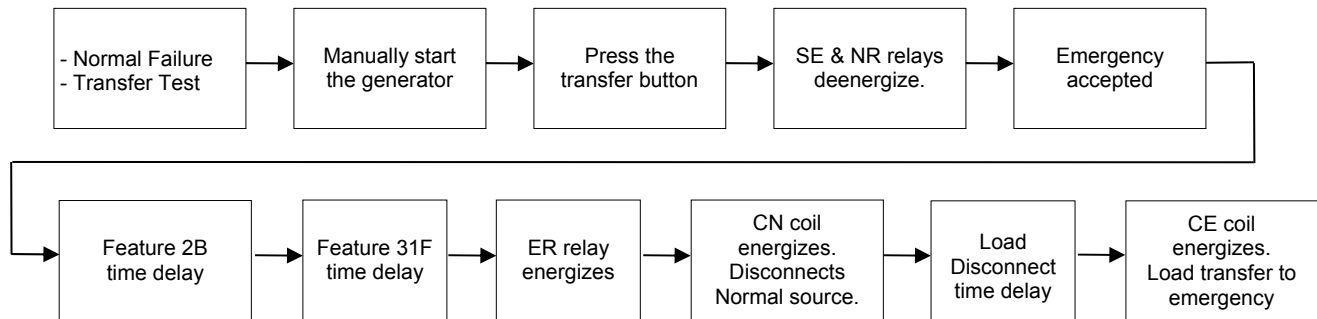

Load Transfer to Emergency

The transfer switch does not transfer the electrical load automatically. The generator is not started automatically. The sequence for load transfer to the emergency source begins when the controller detects a normal source failure, emergency source available, and a transfer test signal (either local or remote), a remote transfer to emergency signal.

Normal Source Failure. The Normal source is considered unacceptable when any one of four voltage or frequency conditions occur (see page 3).

Manually Start the Generator. If the Normal source has failed or to perform a transfer test, manually start the engine-generator first.

Transfer Test Signal. The test transfer signal can be from the transfer button or via the optional serial port (Accessory 11BE). The controller de-energizes the SE relay and NR relay. The controller monitors the emergency source, waiting for it to become acceptable.

When the emergency source becomes acceptable, the controller starts the Feature 2B time delay on transfer to emergency (if desired). Feature 2B time delay allows the emergency source to stabilize before load transfer. If the emergency source fails while Feature 2B time delay is running, the controller again waits for the emergency source to become acceptable again and restarts Feature 2B.

At the conclusion of the Feature 2B time delay, the controller is ready to transfer the load to emergency. If enabled, Feature 31F time delay will run prior to transfer and the Feature 31 output will be active while the time delay runs.

Load Transfer. To transfer the load to the emergency source in a delayed-transition mode the controller energizes ER relay. The transfer switch CN coil energizes and opens the CN transfer switch main contacts. The load is disconnected from both sources. The load disconnect time delay starts. When this time delay ends, the controller energizes the ER relay. The transfer switch CE coil energizes and closes the CE transfer switch main contacts. Transfer switch is now supplying the load from emergency source.

Delayed-Transition Non-Automatic Transfer (3NDTS) continued

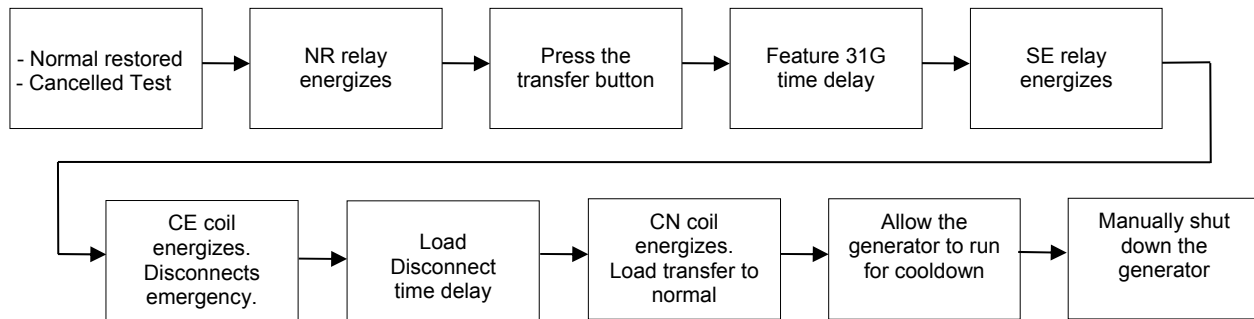

Load Retransfer to Normal

The transfer switch does not retransfer the electrical load automatically. The generator is not stopped automatically. The sequence for load retransfer to the normal source begins when the transfer button is pressed again. A password may need to be entered first.

Normal Source Restoration. The Normal source is considered acceptable again when all four voltage and frequency conditions occur (see page 3).

Transfer Test Signal. The test transfer signal can be from the transfer button or via the optional serial port (Accessory 11BE). The controller monitors the normal source, waiting for it to become acceptable. The controller energizes the NR relay. The controller is ready to transfer the load to normal. If enabled, Feature 31G time delay will run prior to retransfer and the Feature 31 output will be active while the time delay runs.

Load Retransfer. To retransfer the load to the normal source in a delayed-transition mode the controller de-energizes ER and ER2 relays and energizes the SE2 relay. The transfer switch CE coil energizes and opens the CE transfer switch main contacts. The load is disconnected from both sources. The load disconnect time delay starts. When this time delay ends the controller energizes the SE relay. The transfer switch CN coil energizes and closes the CN transfer switch main contacts. The transfer switch is now supplying the load from the normal source again.

Engine Cooldown and Stop. After load retransfer to the normal source, allow the generator to run for a cool down period. Then manually shut down the engine-generator.

Optional Accessories

Several optional accessories are available for the Group G Controller. They can be factory installed or most can be ordered later as an accessory kit.



Deenergize both Normal and Emergency power sources before installing an accessory kit.

Advanced Function Software Bundle

(Accessory 11BE or Kit 935147)

If optional Accessory 11BE software was ordered, the controller is factory configured with additional functions: communication, programmable exerciser, event log, common alarm output contact option OP1 (in the controller). On three pole switches the following additional functions are also enabled: three phase emergency sensing, emergency source unbalance, and phase rotation sensing. The controller has additional screens for these functions.

Communication. Under the *General* settings, a screen allows the user to configure *Communication* (RS485 port). The baud rate can be set off, 9600 – 115200. The address can be set 1 to 247. See the Appendix for setting DIP switches S7 and S8. S7 sets the terminating resistor; S8 sets 2 wire or 4 wire. See pages 4 and 13.

Programmable Exerciser. Under the *Engine Exerciser* settings, a screen allows the user to configure the optional exerciser. This exerciser provides seven programmable exercise periods. They can be set for once a week (all), alternate weeks (1st, 2nd, 3rd, 4th, 5th week), and each with an adjustable start and exercise period. See pages 4, 17 and 18.

Event Log. Under the *Event Log* main menu, a screen allows the user to view events. Use the up and down keys to navigate the event list (last 300 events). See pages 4, 19, 35 (Appendix event types), and 36 (Appendix event causes).

Engine/Common Alarm Input* The Engine/Common Alarm Input is used to connect an external alarm signal from separate equipment to the Transfer Switch controller. This status is visible via screen, alert LED, communications, and will also be logged as an event. Refer to the wiring diagram provided with the transfer switch for connection and rating details. If allowable this setting can be enabled under the Common Alarms section of the General Settings.

**This physical input is shared with the load shed (Acc 30) functionality and as a result only one of these can be used at a time and they cannot be used simultaneously.*

Common Alarm Output. Under the *General* settings, a screen allows the user to configure *Common Alarms*. The Output OP1 contact (in the controller) can be configured to operate when a common alarm occurs. Refer to the wiring diagram provided with the transfer switch for connections and rating of the OP1 contact. See pages 5, 15, 16 and 17 for settings (*Settings, Features*).

3 Phase Emergency Sensing On controllers configured for 3 phase the 11BE will enable the controller to display all three line to line voltages for the emergency source on the screen.

Phase Rotation Monitor Under the *Features* menu the 11BE will allow for 3 phase switches to enable the phase rotation monitor. This feature will allow the user to select between an ABC or CBA phase rotation and will not consider a source acceptable unless it matches the selected rotation orientation.

Emergency Source Unbalance Under the *features* menu the user will be allowed to enable emergency source unbalance for 3 phase switches with 11BE. When enabled the emergency source will not be considered acceptable if the line to line voltages are unbalanced beyond the user configured unbalance drop **3 Phase Emergency Sensing** On controllers configured for 3 phase the 11BE will enable the controller to display all three line to line voltages for the emergency source on the screen.

Emergency Source Unbalance Under the *features* menu the user will be allowed to enable emergency source unbalance for 3 phase switches with 11BE. When enabled the emergency source will not be considered acceptable if the line to line voltages are unbalanced beyond the user configured unbalance dropout.

5140 Quad-Ethernet Module

(Accessory 72EE or Kit 948551)

This accessory provides a 10/100 Mbit Ethernet interface to the transfer switch. It includes embedded web pages and access to Modbus registers for monitoring and control. It is mounted on a DIN rail.

Current Sensing Module

(Accessory 23GA – 1 phase, 23GB – 3 phase, or Kit 935150)

This accessory is a current sensing module that is mounted on the controller (lower part). The customer-supplied current transformer(s) attach to the load cables of the transfer switch. With this accessory installed the controller measures and displays the load current (1 phase, 3 phase, or off). This accessory is not available when a Power Meter is provided. See pages 4, 13 and 14 for settings (*Other Parameters*).

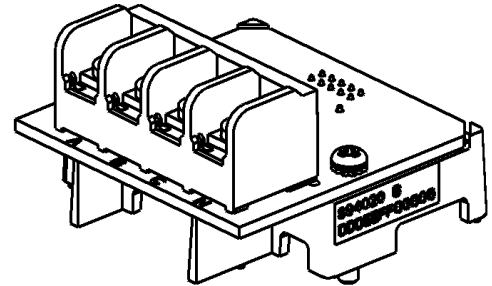

Never leave an open secondary circuit of a current transformer. Dangerous voltage can cause shocks, burns, and/or death. When disconnected always install a shorting jumper between the current transformer terminals.

Relay Expansion Module (Included on 3ADTS & 3NDTS)

(Optional Accessory 18RX for 3ATS & 3NTS or Kit 935148)

This accessory consists of a relay module mounted on a DIN rail. The module interfaces with the controller for dual-operator transfer switches (3ADTS & 3NDTS). It also provides some commonly used accessory relays (18B, 18G, etc.). Output OP2 and OP3 contacts can be configured for common alarms. See pages 4, 15 and 16 for settings (*Features, Output OP1, OP2, OP3*). Refer to transfer switch wiring diagram for connections and rating of OP2 and OP3 contacts.

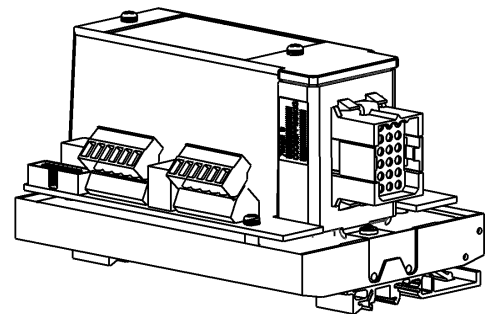

Uninterruptable Power Supply Module

(Accessory 1UP or Kit 935149)

This accessory consists of a module that attaches on a DIN rail. The module provides limited reserve power (approximately 3 minutes) to the controller and some accessories during a power outage until the generator starts. The built-in battery recharges when power is restored.

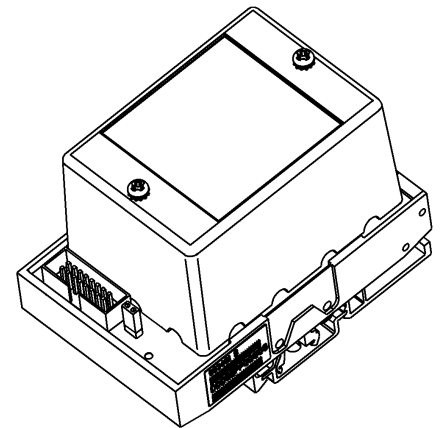

Load Shed (from emergency source)

(Accessory 30AA and 30BA on 3ATS or 3ADTS only, kit not available)

If optional Accessory 30AA or 30BA was ordered, the controller is factory configured for Load Shed. The home / control status screen displays the load shed operation. Load shed can be set to occur only when the sources are inphase (see pages 15 and 16). Refer to the wiring diagram provided with the transfer switch for connections to these accessories.

Accessory 30AA is a load shedding circuit initiated by opening of a customer-supplied contact.

Accessory 30BA* is a load shedding circuit initiated by removal of customer-supplied voltage (*specify voltage).

⚠ DANGER

Hazardous voltage capable of causing shock, burns, or death is used in this switch. Deenergize both Normal and Emergency power sources before making any changes.

NOTICE

Do not make any setting changes while the controller is energized. Any change in these settings may affect the normal operation of the transfer switch. This change could allow the load circuits to remain connected to low voltage source.

This appendix shows the controller DIP switch settings and jumper block settings for input voltage, frequency, phases, and type of transfer switch used. These controls should only be used by trained technicians from ASCO Power Services, Inc. (1-800-800-2726).

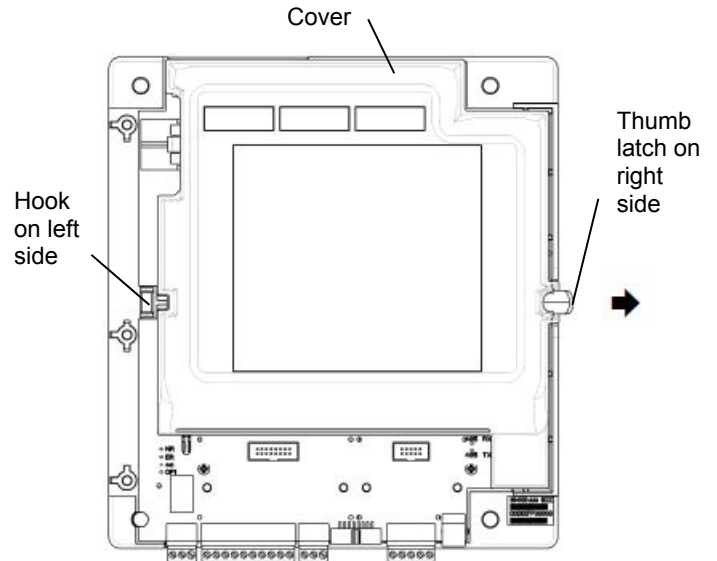

Figure A-1. Cover removal.

Controller Cover Removal

1. Deenergize the controller.
2. Release the cover by pressing the latch outward on the right side with your thumb. Figure A-1.
3. Pull the cover outward and unhook it from the left side.

Controller Cover Installation

1. Position the cover so that the hole on left side engages the hook on the base.
2. Press the cover inward until it latches on the right side. See Figure A-1.
3. Reenergize the controller.

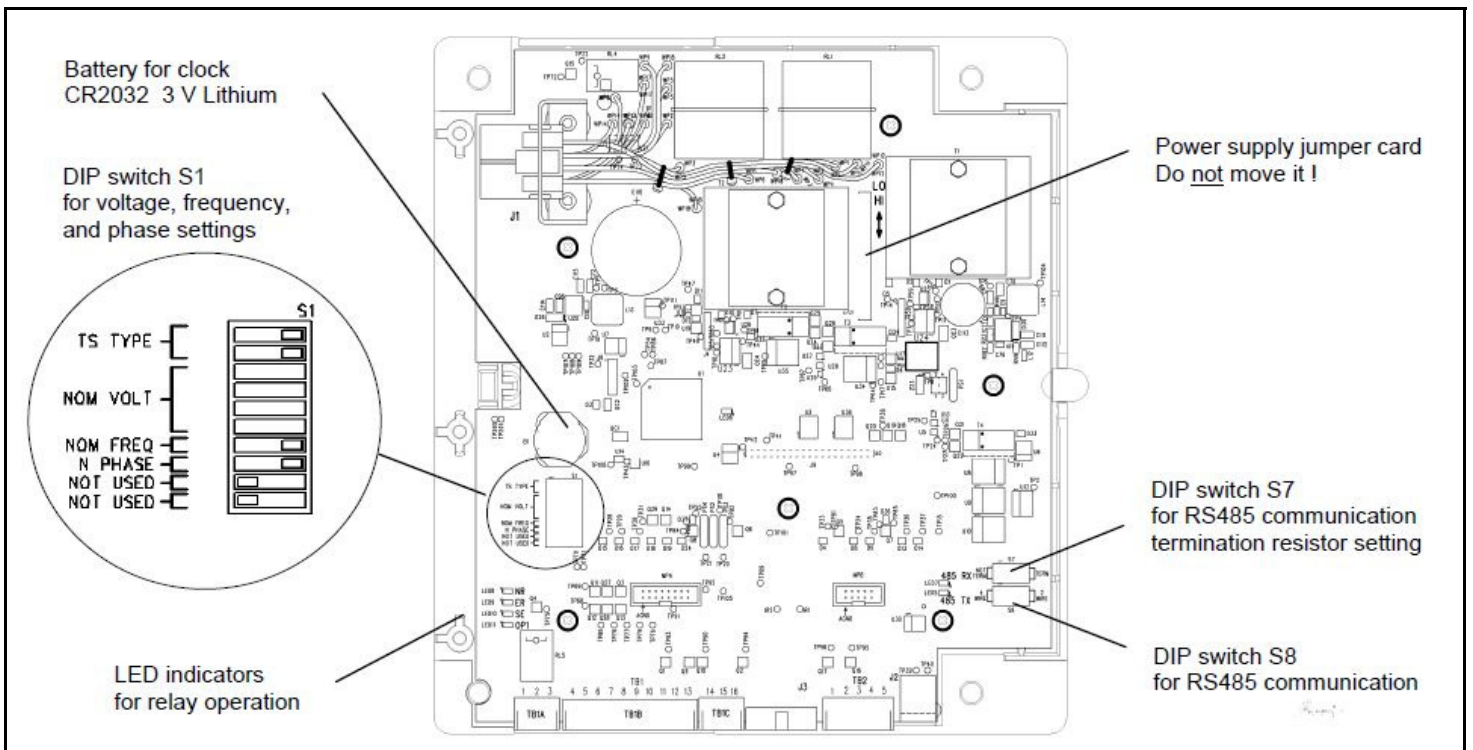

Figure A-2. Location of DIP switches

Power Supply Jumper Card

The power supply jumper card is positioned during manufacture for the customer system voltage. Do not move this card.

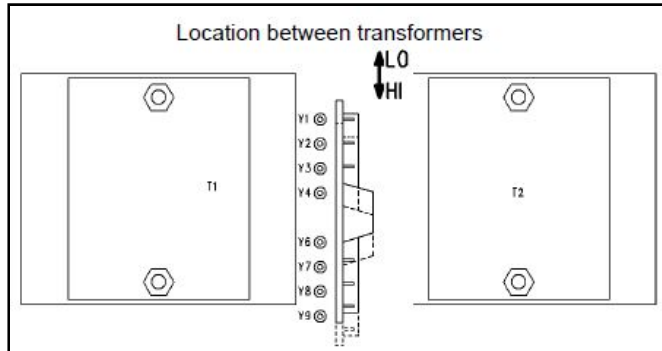

Figure A-3. Power Supply Jumper Card.

Table A-1 shows the appropriate position of the power supply jumper card for different controller part numbers and system voltages.

NOTICE

To avoid permanent damage, be certain that the voltage setting matches the transfer switch system voltage. **Do not apply HI voltage with the jumper card in the LO position.**

Table A-1. Position of Jumper Card.

Controller Part No. 894000-	Position of Jumper Card for system voltage	
	Up ↑ (LO) toward the top	Down ↓ (HI) toward the bottom
001	115V, 120 V	--
002	208V, 220V 230V, 240V	380V, 400V, 415V 440V, 460V, 480V
003	277V	550V, 575V, 600V

Transfer Switch Type Setting

DIP switch S1, actuators 1 and 2 select the type of transfer switch used with the controller (open-transition or delayed-transition). See Table A-2.

NOTICE

To avoid permanent damage be certain that the setting matches the transfer switch type.

Table A-2. Transfer switch type
DIP switch S1, actuators 1 and 2

S1 DIP	Open transition	Delayed transition
1	⇒ on	⇒ on
2	⇒ on	⇐ off

Frequency Setting

DIP switch S1 actuator 7 selects either 50 or 60 Hz source frequency sensing. See Table A-3.

Table A-3. Source Frequency
DIP switch S1, actuator 7

S1 DIP	50 Hz	60 Hz
7	⇐ off	⇒ on

Phase Configuration Setting

DIP switch S1 actuator 8 selects either 1 phase or 3 phase for the Normal source. DIP switch S1 actuator 9 selects either 1 phase or 3 phase for the Emergency source. The 3 phase sensing of the Emergency source is also dependent of the presence of the 11BE option regardless of actuator position. See Table A-4.

Table A-4. Phase Configuration position
DIP switch S1, actuator 8 and 9

S1 DIP	1 Phase	3 Phase
8	⇐ off	⇒ on
9	⇐ off	⇒ on

Voltage Setting

DIP switch S1, actuators 3, 4, 5, and 6 select the voltage setting. See Table A-5.

NOTICE

To avoid permanent damage be certain that the voltage setting matches the transfer switch system voltage.

Table A-5. Voltage setting, DIP switch S1, actuators 3, 4, 5, and 6

S1 DIP switch actuators	115	120	208	220	230	240	277	380	400	415	440	460	480	550	575	600
3	⇐	⇒	⇐	⇒	⇐	⇒	⇐	⇒	⇐	⇒	⇐	⇒	⇐	⇒	⇐	⇒
4	⇐	⇐	⇒	⇒	⇐	⇐	⇒	⇒	⇐	⇐	⇒	⇒	⇐	⇐	⇒	⇒
5	⇐	⇐	⇐	⇐	⇒	⇒	⇒	⇒	⇐	⇐	⇐	⇐	⇒	⇒	⇒	⇒
6	⇐	⇐	⇐	⇐	⇐	⇐	⇐	⇐	⇒	⇒	⇒	⇒	⇒	⇒	⇒	⇒

Logged Events and Causes

See page 19 for how to view logged events and their causes. The following table lists in alphabetical order the **Event Types** that are displayed. The meaning is shown at the right. The next page lists the **Event Causes** (reasons) that are displayed under the event type.

Recorded Event Types

Displayed Event Type	Meaning
Alarm Reset	The alarms were acknowledged.
Clear Event	The event log database was cleared (erased) by a local or remote user.
Clear Statistics	The statistics data was cleared (erased) by a local or remote user.
Clock Set	The clock was set by a local or remote user.
DST Off	The Daylight Savings Time setting was turned off by a local or remote user.
DST On	The Daylight Savings Time setting was turned on by a local or remote user.
DTTS Type Set	The delayed-transition transfer switch type was set.
E Source Accepted	The emergency source has become acceptable.
E Source Not Accepted	The emergency source not acceptable (voltage or frequency dropout or pickup)
Engine Start	The controller has signaled the engine to start.
Engine Stop	The controller has signaled the engine to stop.
Fail to Accept Timer	The emergency source was not accepted within the time setting.
Firmware Updated	The Firmware was updated.
Inphase OFF	The inphase setting was turned off by a local or remote user.
Inphase On	The inphase setting was turned on by a local or remote user.
Internal Error	See HELP in INDEX.
Load Connected	The load was connected to the transfer switch.
Load Disconnected	The load was disconnected from the transfer switch.
Local Transfer Override	Load transfer was cancelled by a local user.
N Source Accepted	The normal source has become acceptable.
N Source Not Accepted	The normal source not acceptable (voltage dropout or pickup).
Not in Automatic	The manual mode enabled or Feature 34B activated.
NVM Defaults Loaded	NVM defaults were loaded.
OTTS Type Set	The open-transition transfer switch type was set.
Password Changed	The password was changed.
Position Error	See HELP in INDEX.
Return to Automatic	The automatic mode was enabled.
Timer 2B Bypass	Feature 2B was bypassed by a local or remote user.
Timer 3A Bypass	Feature 3A was bypassed by a local or remote user.
Timer 31 Bypass	Feature 31 was bypassed by a local or remote user.
Transfer Abort	The transfer has been aborted or cancelled by a local user.
Transfer Committed	Load transfer has been committed by a local or remote user.
Transfer E to N	Transfer from emergency to normal (E source failure, or manual transfer).
Transfer Failure	See HELP in INDEX.
Transfer N to E	Transfer from normal to emergency (N source failure, test, exercise, manual transfer)
TS Initial Position	See HELP in INDEX.

continued on the next page

The following table lists in alphabetical order the **Event Causes** that are displayed under the event type (previous page). The meaning is shown at the right.

Event Cause

Displayed Event Cause	Meaning
Acknowledge Alarms	Alarms acknowledged.
Cancel Test	Test cancelled.
E Not Accepted	Emergency source not accepted.
E Over Frequency	Emergency source over frequency
E Over Voltage	Emergency source over voltage
E Under Frequency	Emergency source under frequency
E Under Voltage	Emergency source under voltage
Engine Exercise	The generator is being exercised.
F6 Aborts NE Transfer	Load transfer cancelled; F6
F34B Inhibit Active	Not in automatic; Feature 34B activated.
Feature 5	Test requested (Feature 5)
Feature 17	Test requested (Feature 17)
Local User	Local user active
Manual Mode Enabled	The manual transfer mode is enabled.
Manual Transfer	The transfer switch is in manual transfer mode.
N Not Accepted	Normal source not accepted.
N Over Frequency	Normal source over frequency
N Over Voltage	Normal source over voltage
N Under Frequency	Normal source under frequency
N Under Voltage	Normal source under voltage
Position Error	See HELP in INDEX.
Remote User	Remote user active
Serial 17	Serial 17 active.
Switch on Center Off	The load is disconnected (for 3DTS, 3NDTS only)
Switch on Emergency	The load is connected to the emergency source.
Switch on Normal	The load is connected to the normal source.

Statistics Kept

See page 19 for how to view the statistics kept. The following table lists the statistics that are displayed. The meaning is shown at the right.

Statistics

Displayed Statistics	Meaning
TS Total Transfers	Number of times the transfer switch has transferred the load.
TS Transfer Time	Total time (sec.) it took to transfer the load between sources.
Source Fail Transfers	Number of times transfer switch has transferred load due to source unacceptable.
Days Energized	Total number of days the ATS has been energized.
Time Normal Available	Total time (hours & minutes) the Normal source has been available.
Total Time On Normal	Total time (hours) the load has been connected to the Normal source.
Time Emerge. Available	Total time (hours & minutes) the Emergency source has been available.
Total Time On Emerg.	Total time (hours) the load has been connected to the Emergency source.
Last Gen Start	Last time (date & time) the generator started.
Gen Starting Time	At that time, how long it took for the generator to become acceptable.
Inphase Time	Time (sec.) it took to run the inphase monitor achieve inphase transfer.

California Proposition 65 Warning—Lead and Lead Compounds

Advertencia de la Proposición 65 de California—Plomo y compuestos de plomo

Avertissement concernant la Proposition 65 de Californie—Plomb et composés de plomb

 **WARNING:** This product can expose you to chemicals including lead and lead compounds, which are known to the State of California to cause cancer and birth defects or other reproductive harm. For more information go to: www.P65Warnings.ca.gov

 **ADVERTENCIA:** Este producto puede exponerle a químicos incluyendo plomo y compuestos de plomo, que es (son) conocido(s) por el Estado de California como causante(s) de cáncer y defectos de nacimiento u otros daños reproductivos. Para mayor información, visite : www.P65Warnings.ca.gov.

 **AVERTISSEMENT:** Ce produit peut vous exposer à des agents chimiques, y compris plomb et composés de plomb, identifiés par l'État de Californie comme pouvant causer le cancer et des malformations congénitales ou autres troubles de l'appareil reproducteur. Pour de plus amples informations, prière de consulter: www.P65Warnings.ca.gov

INDEX

A

About, 4, 19
 Accessories
 1UP, 11, 32
 11BE, 13, 14, 17 thru -11, 31
 18RX, 32
 23GA, 23B, 32
 30AA, 30BA, 32
 dongle, optional, 3
 acknowledge alarms, 3
Alarm Reset, 35
 alarms, 3, 4
 Appendix, 33, 34, 35, 36
 alert light, 2
 acknowledge alarm screen, 3
 Appendix
 battery, 33
 cover removal, 33
 DIP switches, 33, 34
 frequency setting, 34
 LED indicators, 33
 logged events, 35, 36
 phase setting, 34
 statistics, 36
 transfer switch type, 34
 voltage hi-lo card, 33, 34
 voltage setting, 34
Are you sure?, 9, 20
 arrow buttons, 2, 4
 ASCO Power Services Inc.
 800-800-2726(ASCO)
 customer@ascopower.com
 ATS status screen, 3, 4

B

battery, internal, 33
 battery, external, 11, 13, 14, 32
 baud rate, communication, 13, 14
 buttons, 2
Bypass, Features, 11, 12, 15, 16
Bypass Timer button, 2

C

Cancel Test, 36
 change password, 9, 13, 14
Clear Events, 13, 14, 35
Clear Statistics, 35
Clock Set, 35
Commit Transfer, 15, 16
Common Alarms settings, 4, 13,
 14, 31
Communication settings, 4, 13,
 14, 31
 connectivity via Modbus, 13
 refer to 381339-310
Contrast, Display, 13, 14
 control messages, 22
 control overview, 2, 4
 cooldown, engine, 11, 12, 21, 24
 cover removal, 33
CT Ratio, 13, 14
 current sensing, 3, 13, 14, 32

D

DANGER statements, cover, 33
Date & Time settings, 3, 4,
 13, 14
Day of Week, exerciser, 17, 18
 daylight savings time, 13, 14, 35
 decrease value button, 2
 delayed transition transfer, 25,
 26, 29, 30, 34
 description of operation
 3ATS, 23, 24
 3ADTS, 25, 26
 3NTS, 27, 28
 3NDTS, 29, 30
 shed load, 31
 DIP switches, 33, 34
 display messages, 21, 22
Display settings, 4, 13, 14
 Contrast, 13, 14
 Language, 13, 14
 Source 1/2, 13, 14
 Volt Label, 13, 14
 dongle, optional, 3
 drop out settings, 4, 10
DST, 13, 14, 35
Duration, exerciser, 17, 18

E

E Accept Fail, 13, 14, 20
E Source Accepted, 35
E Source Not Accepted, 35
E Accept Fail, 13, 14, 20
Emergency → *Normal Timer*, 11,
 12, 21
Enable, exerciser, 17, 18
Engine Cooldown Timer, 11, 12,
 21, 24
Engine Exerciser settings, 17, 18
 Day of Week, 17, 18
 Duration, 17, 18
 Enable, 17, 18
 Program No, 17, 18
 Time, 17, 18
 With Load, 17, 18
Enter Password, 4, 9, 13, 14, 21
 enter/save button, 2, 4
 escape button, 2, 4
Event Log, 19, 31, 35, 36
Exerciser, Engine, 17, 18, 31
 explanations
 engine exercisers, 18
 features, 16
 general, 14
 screen messages, 20
 time delays, 12
 voltage and frequency, 10
Ext. Battery, 11, 13, 14
Ext. Feature 6B, 15, 16
Ext. Feature 17, 15, 16

F

Fail Accept Timer, 15, 16
Fail Acquire E, 21
Features settings, 15, 16
 BP E→N F31 E Fail, 15, 16
 BP N→E F31 N Fail, 15, 16
 Commit Transfer, 15, 16
 Ext. Feature 6B, 17, 15, 16
 Fail Accept Timer, 15, 16
 Inphase On, 15, 16
 Output OP4, 15, 16
 6DL, 2, 15, 16, 20
Feature 6DL Active, 20
Format, Date & Time, 13, 14
 frequency, 3, 10, 34

INDEX

G

General settings, 4, 13, 14
Common Alarms, 13, 14
Communication, 13, 14
Date & Time, 13, 14
Display, 13, 14
Name & Location, 13, 14
Other Parameters, 13, 14

H

HELP 800-800-2726(ASCO)
 customercare@ascopower.co

m

home screen (main menu), 4, 9

I

increase value key, 2
 Inphase, 11, 12, 15, 16, 32, 36
Internal Error, 35
 interval, exerciser, 17, 18
 increase value button, 2
Invalid Password, 9, 13, 14, 21

K

key symbol, dongle, optional, 3

L

Language, Display, 13, 14
 legend, 4, 5, 6, 7, 8
 lights, 2, 33
Ld Disconnect setting, 13, 14, 21
Load Connected, 35
Load Disconnect Timer, 21
Load Disconnected, 32, 35
Load on Emergency, 21
Load on Normal, 3, 21
Load Shed, 32
Load Transfer Override, 36
Local User, 36
Location, Name &, 4, 13, 14
Loss E when on E, 13, 14, 20

M

Main Menu, 4, 9
Manual Mode Enabled, 36
 manual operation, 2
 3NTS, 7, 27, 28
 3NDTS, 8, 29, 30
 Feature 6DL, 15, 16, 20
Manual Transfer, 36
 messages, display, 3, 20, 21
 metering screen, 3, 4
 Modbus connectivity, 13
 refer to 381339-310









N

N Not Accepted, 36
N Over Frequency, 36
N Over Voltage, 36
N Source Accepted, 35
N Source Not Accepted, 35
N Under Frequency, 36
N Under Voltage, 36
Name & Location, 13, 14
 navigation, screen, 4
No Active Alarms, 3, 21
 non-automatic operation
 3NTS, 27
 3NDTS, 29
Normal → Emergency Timer, 11, 12, 21
Normal Fail Timer, 11, 12, 21
Normal Failed, 21, 23
Normal OK, 3, 20, 21, 24
Not in Automatic, 36
 not in automatic light, 2
NVM Defaults Loaded, 36

O

operation, description of
 3ATS, 23, 24
 3ADTS, 25, 26
 3NTS, 27, 28
 3NDTS, 29, 30
 optional accessories, 31, 32
Other Parameters, 4, 13, 14
 Clear Events, 13, 14
 CT Ratio, 13, 14
 Current Sensing, 13, 14
 Ext. Battery, 13, 14
 Password, 13, 14
OF over frequency trip, 10
OTTS Type Set, 36
Output OP, 15, 16
OV over voltage trip, 10
 overview, 2, 4

P

password, 4, 9, 13, 14, 21
 General → *Other Parameters*
 password, default, **1111**
 phase setting, configuration, 34
 phase rotation monitor, 16, 31
 pick up settings, 4, 10
Position Error, 35, 36
Post Transfer Timer, 11, 12, 21
 power supply, 32, 33, 34
Pre Transfer Timer, 11, 12, 21
Present Time, exerciser, 17, 18
 Press  *Abort Transfer*, 22
 Press  *Bypass Timer*, 22
 Press  *Re-Transfer*, 22
 Press  *Test Transfer*, 22
 Press  *Transfer*, 22
 Press  to acknowledge
 alarms, 22
 Press  to Test, 22
 Press  to Transfer, 22
 Press  to Cancel, 22
Program No, exerciser, 17, 18
 programmable engine exerciser,
 17, 18, 31
 protocol, communication, 13
PU/DO pick up/drop out, 10

R

relay expansion module, 32
 retransfer button, 2
Return to Automatic, 35
RS-485, Communication, 15, 16

INDEX

S

screen messages, 20, 21
 screen navigation, 4
 sequence of operation, 5 thru 8
Serial 17, 36
Serial Feature 17, 15, 16
Settings, 4, 9, 10
 General, 4, 13, 14
 Engine Exerciser, 4, 17, 18
 Features, 4, 15, 16
 Pick Up / Drop Out, 4, 10
 Timers, 4, 11, 12
Source 1/2, Display, 13, 14
 source acceptability, 3, 20
Start Week, exerciser, 17, 18
Statistics, 91, 36
 status information, 3, 4, 20
 status lights, 2
Switch on Center Off, 36
Switch on Emergency, 36
Switch on Normal, 36

T

Test Mode, 21, 23
3 Phase Emergency Setting, 31
Time, Date & Time, 4, 13, 14
Time, start, exerciser, 17, 18
Time Delay 2B Bypass, 35
Time Delay 3A Bypass, 35
Time Delay 31 Bypass, 35
Timers (time delays) settings, 4
 1C & 1F, 11, 12, 23
 2B, 11, 12
 2E, 11, 12
 3A, 11, 12
 31F, 11, 12
 31G, 11, 12
 31M, 11, 12
 31N, 11, 12
 Fail Accept Max, 11, 12
 Inphase, 11, 12
 Ld Disconnect, 11, 12
Transfer Abort, 35
 transfer button, 2
Transfer Committed, 36
Transfer E to N, 35
Transfer Failure, 35
Transfer Inhibit Signal, 21
Transfer N to E, 35
 transfer switch, 2
 see *Installation Manual*
 type setting, 34
 transfer test, 2
Transfer to Emergency Inhibited, 21
Transfer to Normal Inhibited, 21
 transformers, jumper card, 34
TS Initial Position, 35

U

unbalance, 3, 10
 ups, 31

V

Volt Label, Display, 13, 14
Volt Unbalance, 10, 15, 16
 voltage, 3, 10, 13, 14, 20,
 23 through 30, 33, 34, 35
 jumper card, 34
 setting, 34

W

Waiting for Emergency Available,
 21, 23
Waiting for Inphase, 21, 4-9
Waiting for Retransfer Signal, 21
With Load, exerciser, 17, 18