

CIG – 100kW

CUMMINS / C100D6C 100



**Sales and
Service**

Cummins Sales and Service

NOTICE

A COPY OF THIS GENERATOR SET SUBMITTAL MUST BE RETURNED TO OUR OFFICE, APPROVED IN ITS ENTIRETY AND BEARING THE DATE OF APPROVAL, STAMP OR SIGNATURE AND TITLE OF THE APPROVING AUTHORITY, BEFORE ANY ITEM WILL BE RELEASED FOR MANUFACTURE OR SHIPMENT. WE ASSUME NO RESPONSIBILITY FOR DELAYS IN OUR FORECASTED SHIPPING SCHEDULES ON ANY ITEM ON WHICH SUBMITTAL APPROVAL IS BEYOND THIRTY (30) DAYS FROM THE SUBMISSION DATE ON THE COVER PAGE.

THIS SUBMITTAL IS BASED UPON OUR INTERPRETATION OF THE PROJECT REQUIREMENTS AND/OR SPECIFICATIONS AND IS IN ACCORDANCE WITH YOUR ORDER AND PRODUCT AVAILABILITY OF FROM OUR VENDORS. PLEASE REVIEW THE ENCLOSED DATA COMPLETELY AND CAREFULLY. SHOULD ADDITIONAL INFORMATION OR CLARIFICATION BE REQUIRED PLEASE FORWARD A SUBMITTAL COPY, COMPLETE WITH YOUR NOTATIONS, TO OUR OFFICE WITHIN THIRTY (30) DAYS FOR A PROMPT RESPONSE AND/OR RESUBMITTAL.

CONSIDERABLE ATTENTION IS GIVEN TO THE PREPARATION OF THIS SUBMITTAL TO ENSURE IT IS COMPLETE, CONCISE AND CORRECT AS IS POSSIBLE. PLEASE REVIEW IT CAREFULLY AND THOROUGHLY.

Table of Contents

CIG – 100kW

	Page
Cover Letter	1
Notice Letter	2
Table of Contents	3
Bill of Materials	4-5
Generator Specification Sheet	6-11
Generator Data Sheet	12-14
Generator PowerCommand Control - PCC 1.1	15-20
Generator Alternator Data Sheet	21-22
Prototype Test Certificate	23
Prototype Test Summary Report	24
Generator Open Unit Drawing	25-26
Generator Circuit Breaker Specification Sheet	27-29
Generator Circuit Breaker Drawing	30
Generator Accessories Option Drawing.pdf	31-32
Generator Enclosure Sound Data Sheet	33-34
Generator Fuel Tank Specification Sheet	35-37
Generator Enclosure Drawing	38-39
Generator Fuel Tank Drawing	40-42
Generator Battery Charger Specification Sheet	43-44
Generator Warranty Statement - Base	45-46



Bill of Materials

Product Code	DESCRIPTION	QTY
	Diesel Genset, 60Hz, 100kW	2
	U.S. EPA, Stationary Emergency Application	2
C100D6C	C100D6C, Diesel Genset, 60Hz, 100kW	2
_R002-2	Voltage - 277 / 480, 3 Phase, Wye, 4 Wire	2
_B943-2	Alternator - 60Hz, 12L, 480 / 277V, 120C, 40C Ambient	2
_BB89-2	Battery Charger - 6 Amp, Regulated	2
_A333-2	Battery Charging Alternator	2
_KV42-2	Circuit Breaker, Location A, 150A, 3P, 600 Volts AC, 80%, UL	2
_H609-2	Control Mounting - Left Facing	2
_H700-2	PowerCommand1.1 Controller	2
_E153-2	Coolant Heater	2
_L169-2	Emissions Cert, EPA, Tier 3, NSPS CI Stationary Emergency	2
_P176-2	Enclosure Color - Green, Aluminum	2
_F252-2	Enclosure - Wind Load 180 MPH, ASCE7-10	2
_A366-2	Engine Governor - Electronic, Isochronous	2
_D041-2	Engine Air Cleaner - Normal Duty	2
_H669-2	Engine Coolant - 50% Antifreeze, 50% Water Mixture	2
_E125-2	Engine Cooling - Radiator, High Ambient Air Temperature, Ship Fitted	2
_H706-2	Engine Oil	2
_A422-2	Engine Starter - 12 Volt DC Motor	2
_H536-2	Control Display Language - English	2
_L050-2	Literature - English	2
_B184-2	Exciter / Regulator - Permanent Magnet Generator, 3 Phase Sensor	2
_E089-2	Extension - Coolant Drain	2
_H268-2	Extension - Oil Drain	2
_C319-2	UL142 Sub Base Dual Wall Basic, Diesel Fuel Tank, 24 Hour Minimum	2
_H012-2	Gauge - Oil Pressure	2
_L028-2	Genset Warranty - 2 Years Base	2
_F217-2	Aluminum Sound Attenuated Level 2 Enclosure, with Exhaust System	2
_L090-2	Listing - UL 2200	2
_KV03-2	Load Connection - Single	2
_C312-2	Mechanical Fuel Gauge	2
_L193-2	NFPA 110 Type 10 Level 1 Capable	2
_F253-2	Larger Battery Rack	2
_C127-2	Fuel Water Separator	2



Product Code	DESCRIPTION	QTY
_L260-2	Green Sound Level 2 Intake Baffle - Ship Loose	2
_F179-2	Skidbase - Housing Ready	2
_A331-2	Duty Rating - Standby Power (ESP)	2
_K796-2	Stop Switch - Emergency	2
_C318-2	Switch - Fuel Tank, Rupture Basin	2
_C310-2	Low Fuel Level Switch, 40%	2
_H527-2	Warning - Low Coolant Level	2



Diesel Generator Set

QSB5 Series Engine
50-125 kW Standby
EPA Tier 3 Emissions



Description

Cummins® generator sets are fully integrated power generation systems providing optimum performance, reliability and versatility for stationary Standby applications.

Features

Heavy duty engine - Rugged 4-cycle industrial diesel delivers reliable power and fast response to load changes.

Alternator - Several alternator sizes offer selectable motor starting capability with low reactance 2/3 pitch windings, low waveform distortion with non-linear loads and fault clearing short-circuit capability.

Control system - The PowerCommand® 1.1 electronic control is standard equipment and provides total generator set system integration including automatic remote starting/stopping, precise frequency and voltage regulation, alarm and status message display, output metering, auto-shutdown at fault detection and NFPA 110 Level 1 compliance. The PowerCommand 2.3 control is also optional and is UL 508 Listed and provides AmpSentry™ protection.

Cooling system - Standard cooling package provides reliable running at up to 50 °C (122 °F) ambient temperature.

Enclosures - The aesthetically appealing enclosure incorporates special designs that deliver one of the quietest generators of its kind. Aluminium material plus durable powder coat paint provides the best anti-corrosion performance. The generator set enclosure has been evaluated to withstand 180 MPH wind loads in accordance with ASCE7 -10. The design has hinged doors to provide easy access for service and maintenance.

Fuel tanks - Dual wall sub-base fuel tanks are offered as optional features, providing economical and flexible solutions to meet extensive code requirements on diesel fuel tanks.

NFPA - The generator set accepts full rated load in a single step in accordance with NFPA 110 for Level 1 systems.

Warranty and service - Backed by a comprehensive warranty and worldwide distributor network.

Model	Standby 60 Hz		Prime 60 Hz		Data sheets
	kW	kVA	kW	kVA	
C50D6C	50	63	45	56	NAD-6333-EN
C60D6C	60	75	54	68	NAD-6334-EN
C80D6C	80	100	72	90	NAD-6335-EN
C100D6C	100	125	90	113	NAD-6336-EN
C125D6C	125	156	112.5	141	NAD-6216-EN

Generator Set Specifications

Governor regulation class	ISO8528 Part 1 Class G3
Voltage regulation, no load to full load	± 1.0%
Random voltage variation	± 1.0%
Frequency regulation	Isochronous
Random frequency variation	± 0.50%
Radio frequency emissions compliance	FCC code title 47 part 15 class A and B

Engine Specifications

Design	Turbocharged and charge air cooled
Bore	107 mm (4.21 in.)
Stroke	124 mm (4.88 in.)
Displacement	4.5 L (272 in ³)
Cylinder block	Cast iron, in-line 4 cylinder
Battery capacity	850 amps per battery at ambient temperature of 0 °C (32 °F)
Battery charging alternator	100 amps
Starting voltage	2 x 12 volt in parallel, negative ground
Lube oil filter type(s)	Spin-on with relief valve
Standard cooling system	High ambient radiator
Rated speed	1800 rpm

Alternator Specifications

Design	Brushless, 4 pole, drip proof, revolving field
Stator	2/3 pitch
Rotor	Direct coupled, flexible disc
Insulation system	Class H per NEMA MG1-1.65
Standard temperature rise	120 °C (248 °F) Standby
Exciter type	Torque match (shunt) with PMG as option
Alternator cooling	Direct drive centrifugal blower
AC waveform Total Harmonic Distortion (THDV)	< 5% no load to full linear load, < 3% for any single harmonic
Telephone Influence Factor (TIF)	< 50 per NEMA MG1-22.43
Telephone Harmonic Factor (THF)	< 3%

Available Voltages

1-phase		3-phase			
• 120/240	• 120/208	• 120/240	• 277/480	• 347/600	• 127/220

Generator Set Options

Fuel system

- Basic fuel tanks
- Regional fuel tanks

Engine

- Engine air cleaner – normal or heavy duty
- Shut down – low oil pressure
- Extension – oil drain
- Engine oil heater

Alternator

- 120 °C temperature rise alternator
- 105 °C temperature rise alternator
- PMG excitation
- Alternator heater, 120 V
- Reconnectable full 1 phase output alternator

Control

- AC output analog meters
- Stop switch – emergency
- Auxiliary output relays (2)
- Auxiliary configurable signal inputs (8) and relay outputs (8)

Electrical

- One, two or three circuit breaker configurations
- 80% rated circuit breakers
- 80% or 100% rated LSI circuit breakers
- Battery charger

Enclosure

- Sound Level 1 or Level 2 enclosure, sandstone or green color
- Weather protective enclosure with muffler installed, green color
- Winter protective enclosure, green color

Cooling system

- Shutdown – low coolant level
- Warning – low coolant level
- Extension – coolant drain
- Coolant heater options:
 - <4 °C (40 °F) – cold weather
 - <-18 °C (0 °F) – extreme cold

Exhaust system

- Exhaust connector NPT
- Exhaust muffler mounted

Generator set application

- Base barrier – elevated genset
- Radiator outlet duct adapter

Warranty

- Base warranty – 2 year/1000 hours, Standby
- Base warranty – 1 year/unlimited hours, Prime
- 3 year Standby warranty options
- 5 year Standby warranty options

Generator Set Accessories

• Coolant heater

- Battery heater kit
- Engine oil heater
- Remote control displays
- Auxiliary output relays (2)
- Auxiliary configurable signal inputs (8) and relay outputs (8)
- Annunciator – RS485
- Audible alarm

- Remote monitoring device – PowerCommand 500/550
- Battery charger – stand-alone, 12 V

• Circuit breakers

- Enclosure Sound Level 1 to Sound Level 2 upgrade kit
- Base barrier – elevated generator set

- Mufflers – industrial, residential or critical

• Alternator PMG excitation

- Alternator heater

Control System PowerCommand 1.1

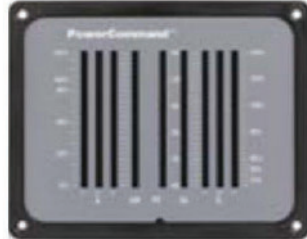

PowerCommand control is an integrated generator set control system providing voltage regulation, engine protection, operator interface and isochronous governing (optional). Major features include:

- Battery monitoring and testing features and smart starting control system.
- Standard PCCNet interface to devices such as remote annunciator for NFPA 110 applications.
- Control boards potted for environmental protection.
- Control suitable for operation in ambient temperatures from -40 °C to +70 °C (-40 °F to +158 °F) and altitudes to 5000 meters (13,000 feet).
- Prototype tested; UL, CSA, and CE compliant.
- InPower™ PC-based service tool available for detailed diagnostics.

Operator/display panel

- Manual off switch
- Alpha-numeric display with pushbutton access for viewing engine and alternator data and providing setup, controls and adjustments (English or international symbols)
- LED lamps indicating generator set running, not in auto, common warning, common shutdown, manual run mode and remote start
- Suitable for operation in ambient temperatures from -40 °C to +70 °C

- Bargraph display (optional)

AC protection

- Over current warning and shutdown
- Over and under voltage shutdown
- Over and under frequency shutdown
- Over excitation (loss of sensing) fault
- Field overload

Engine protection

- Overspeed shutdown
- Low oil pressure warning and shutdown
- High coolant temperature warning and shutdown
- Low coolant level warning or shutdown

- Low coolant temperature warning
- High, low and weak battery voltage warning
- Fail to start (over crank) shutdown
- Fail to crank shutdown
- Redundant start disconnect
- Cranking lockout
- Sensor failure indication
- Low fuel level warning or shutdown

Alternator data

- Line-to-Line and Line-to-neutral AC volts
- 3-phase AC current
- Frequency
- Total kVA

Engine data

- DC voltage
- Lube oil pressure
- Coolant temperature
- Engine speed

Other data

- Generator set model data
- Start attempts, starts, running hours
- Fault history
- RS485 Modbus® interface
- Data logging and fault simulation (requires InPower service tool)

Digital governing (optional)

- Integrated digital electronic isochronous governor
- Temperature dynamic governing

Digital voltage regulation

- Integrated digital electronic voltage regulator
- 2-phase Line-to-Line sensing
- Configurable torque matching

Control functions

- Time delay start and cooldown
- Cycle cranking
- PCCNet interface
- (2) Configurable inputs
- (2) Configurable outputs
- Remote emergency stop
- Automatic Transfer Switch (ATS) control
- Generator set exercise, field adjustable

Options

- Auxiliary output relays (2)
- Remote annunciator with (3) configurable inputs and (4) configurable outputs
- **PMG alternator excitation**
- PowerCommand 500/550 for remote monitoring and alarm notification (accessory)
- Auxiliary, configurable signal inputs (8) and configurable relay outputs (8)
- AC output analog meters (bargraph)
 - Color-coded graphical display of:
 - 3-phase AC voltage
 - 3-phase current
 - Frequency
 - kVa
- Remote operator panel
- PowerCommand 2.3 control with AmpSentry protection

Ratings Definitions

Emergency Standby Power (ESP):

Applicable for supplying power to varying electrical load for the duration of power interruption of a reliable utility source. Emergency Standby Power (ESP) is in accordance with ISO 8528. Fuel Stop power in accordance with ISO 3046, AS 2789, DIN 6271 and BS 5514.

Limited-Time Running Power (LTP):

Applicable for supplying power to a constant electrical load for limited hours. Limited Time Running Power (LTP) is in accordance with ISO 8528.

Prime Power (PRP):

Applicable for supplying power to varying electrical load for unlimited hours. Prime Power (PRP) is in accordance with ISO 8528. Ten percent overload capability is available in accordance with ISO 3046, AS 2789, DIN 6271 and BS 5514.

Base Load (Continuous) Power (COP):

Applicable for supplying power continuously to a constant electrical load for unlimited hours. Continuous Power (COP) in accordance with ISO 8528, ISO 3046, AS 2789, DIN 6271 and BS 5514.

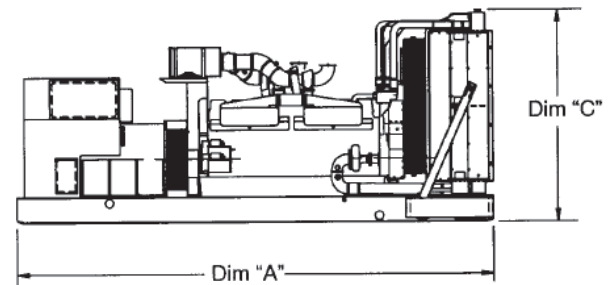
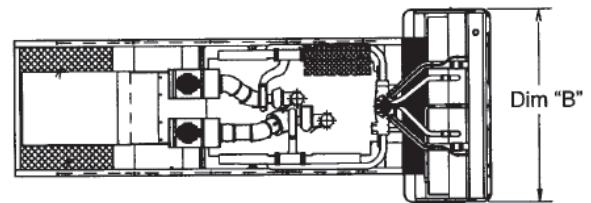

This outline drawing is for reference only. See respective model data sheet for specific model outline drawing number.





Do not use for installation design

Model	Dim "A" mm (in.)	Dim "B" mm (in.)	Dim "C" mm (in.)	Set weight* kg (lbs.)
Open set				
C50D6C	2482 (98)	1016 (40)	1321 (52)	958 (2113)
C60D6C	2482 (98)	1016 (40)	1321 (52)	1006 (2217)
C80D6C	2482 (98)	1016 (40)	1321 (52)	1054 (2324)
C100D6C	2482 (98)	1016 (40)	1321 (52)	1106 (2439)
C125D6C	2482 (98)	1016 (40)	1321 (52)	1173 (2586)
Weather protective enclosure				
C50D6C	2482 (98)	1016 (40)	1473 (58)	1039 (2290)
C60D6C	2482 (98)	1016 (40)	1473 (58)	1087 (2396)
C80D6C	2482 (98)	1016 (40)	1473 (58)	1135 (2503)
C100D6C	2482 (98)	1016 (40)	1473 (58)	1187 (2618)
C125D6C	2482 (98)	1016 (40)	1473 (58)	1254 (2765)
Sound attenuated enclosure Level 1				
C50D6C	3016 (119)	1016 (40)	1473 (58)	1221 (2693)
C60D6C	3016 (119)	1016 (40)	1473 (58)	1137 (2507)
C80D6C	3016 (119)	1016 (40)	1473 (58)	1185 (2614)
C100D6C	3016 (119)	1016 (40)	1473 (58)	1237 (2729)
C125D6C	3016 (119)	1016 (40)	1473 (58)	1304 (2876)
Sound attenuated enclosure Level 2				
C50D6C	3456 (136)	1016 (40)	1473 (58)	1228 (2708)
C60D6C	3456 (136)	1016 (40)	1473 (58)	1144 (2522)
C80D6C	3456 (136)	1016 (40)	1473 (58)	1192 (2629)
C100D6C	3456 (136)	1016 (40)	1473 (58)	1244 (2744)
C125D6C	3456 (136)	1016 (40)	1473 (58)	1311 (2891)
Winter protective enclosure				
C50D6C	3701 (146)	1016 (40)	1473 (58)	1254 (2758)
C60D6C	3701 (146)	1016 (40)	1473 (58)	1169 (2572)
C80D6C	3701 (146)	1016 (40)	1473 (58)	1218 (2679)
C100D6C	3701 (146)	1016 (40)	1473 (58)	1270 (2794)
C125D6C	3701 (146)	1016 (40)	1473 (58)	1337 (2941)

* Weights above are average. Actual weight varies with product configuration.

Codes and Standards

Codes or standards compliance may not be available with all model configurations – consult factory for availability.

	<p>This generator set is designed in facilities certified to ISO 9001 and manufactured in facilities certified to ISO 9001 or ISO 9002.</p>		<p>The generator set is available Listed to UL 2200, Stationary Engine Generator Assemblies.</p>
	<p>The Prototype Test Support (PTS) program verifies the performance integrity of the generator set design. Cummins products bearing the PTS symbol meet the prototype test requirements of NFPA 110 for Level 1 systems.</p>	<p>U.S. EPA</p>	<p>Engine certified to U.S. EPA SI Stationary Emission Regulation 40 CFR, Part 60.</p>
	<p>All low voltage models are CSA certified to product class 4215-01.</p>	<p>International Building Code</p>	<p>The generator set is certified to International Building Code (IBC) 2012.</p>

Warning: Back feed to a utility system can cause electrocution and/or property damage. Do not connect to any building's electrical system except through an approved device or after building main switch is open.

For more information contact your local Cummins distributor or visit power.cummins.com

Our energy working for you.™





Generator set data sheet

Model:	C100D6C
Frequency:	60 Hz
Fuel type:	Diesel
KW rating:	100 standby 90 prime
Emissions level:	EPA Tier 3, Stationary emergency

Exhaust emission data sheet:	EDS-2029
Exhaust emission compliance sheet:	EPA-3042
Sound performance data sheet:	MSP-1303
Cooling performance data sheet:	MCP-1403
Prototype test summary data sheet:	PTS-450

Fuel consumption	Standby				Prime			
	kW (kVA)				kW (kVA)			
Ratings	100 (125)				90 (113)			
Load	1/4	1/2	3/4	Full	1/4	1/2	3/4	Full
US gph	2.80	4.80	6.90	8.90	2.40	4.30	6.40	7.70
L/hr	10.60	18.17	26.12	33.69	9.08	16.28	24.23	29.15

Engine	Standby rating	Prime rating
Engine manufacturer	Cummins Inc.	
Engine model	QSB5-G13	
Configuration	Cast iron, in-line, 4 cylinder	
Aspiration	Turbocharged and charge air cooled	
Gross engine power output, kWm (bhp)	129 (173)	113 (152)
BMEP at set rated load, kPa (psi)	1965 (285)	1696 (246)
Bore, mm (in)	107 (4.21)	
Stroke, mm (in)	124 (4.88)	
Rated speed, rpm	1800	
Piston speed, m/s (ft/min)	7.44 (1464)	
Compression ratio	17.3:1	
Lube oil capacity, L (qt)	12.2 (12.9)	
Overspeed limit, rpm	2250	

Fuel flow

Maximum fuel flow, L/hr (US gph)	133 (35.0)
Maximum fuel inlet restriction with clean filter, mm Hg (in Hg)	127 (5.0)

Air	Standby rating	Prime rating
Combustion air, m ³ /min (scfm)	9.995 (353)	10.11 (357)
Maximum air cleaner restriction with clean filter, kPa (in H ₂ O)	1.25 (5)	

Exhaust

Exhaust flow at set rated load, m ³ /min (cfm)	24.9 (878)	22.4 (790)
Exhaust temperature, °C (°F)	489 (913)	431 (808)
Maximum back pressure, kPa (in H ₂ O)	10 (40.18)	10 (40.18)
Available exhaust back pressure with CPG sound level 2 enclosure muffler, kPa (in H ₂ O)	0 (0)	1.0 (4)
Available exhaust back pressure with CPG weather enclosure muffler, kPa (in H ₂ O)	1.0 (4)	2.0 (8)

Standard set-mounted radiator cooling

Ambient design, °C (°F)	50 (122)	
Fan load, kW _m (HP)	5.22 (7)	
Coolant capacity (with radiator), L (US Gal)	16 (4.2)	
Cooling system air flow, m ³ /min (scfm)	218.04 (7700)	
Total heat rejection, MJ/min (Btu/min)	12.22 (11584)	11.33 (10736)
Maximum cooling air flow static restriction, kPa (in H ₂ O)	0.12 (0.5)	

Weight²

Unit wet weight kgs (lbs)	1106 (2439)
---------------------------	-------------

see below drawings for overall shipping weight and dimensions

Notes:

¹ For non-standard remote installations contact your local Cummins Power Generation representative.

² Weights represent a set with standard features. See outline drawing for weights of other configurations.

Derating factors

Standby	Engine power available to 1295 m (4250 ft) and ambient temperatures up to 40° C (104° F). Above these conditions, derate at 17.5% per 300 m (1000 ft) until 1700 m (5600 ft) and then derate at 2.2% per 300 m (1000 ft). Also derate 16.1% per 10° C (18° F)
Prime	Engine power available to 1448 m (4750 ft) and ambient temperatures up to 40° C (104° F). Above these conditions, derate at 17.5% per 300 m (1000 ft) until 1700 m (5600 ft) and then derate at 2.3% per 300 m (1000 ft). Also derate 18.8% per 10° C (18° F)

Ratings definitions

Emergency standby power (ESP):	Limited-time running power (LTP):	Prime power (PRP):	Base load (continuous) power (COP):
Applicable for supplying power to varying electrical load for the duration of power interruption of a reliable utility source. Emergency Standby Power (ESP) is in accordance with ISO 8528. Fuel Stop power in accordance with ISO 3046, AS 2789, DIN 6271 and BS 5514.	Applicable for supplying power to a constant electrical load for limited hours. Limited Time Running Power (LTP) is in accordance with ISO 8528.	Applicable for supplying power to varying electrical load for unlimited hours. Prime Power (PRP) is in accordance with ISO 8528. Ten percent overload capability is available in accordance with ISO 3046, AS 2789, DIN 6271 and BS 5514.	Applicable for supplying power continuously to a constant electrical load for unlimited hours. Continuous Power (COP) is in accordance with ISO 8528, ISO 3046, AS 2789, DIN 6271 and BS 5514.

Alternator data

Standard Alternators	Single phase ²		Three phase ¹				
Maximum temperature rise above 40 °C ambient	120 °C	120 °C	120 °C	120 °C	120 °C	120 °C	120 °C
Feature code	BB88-2 ³	BB90-2	B946-2	B986-2	B943-2	B952-2	BB86-2
Alternator data sheet number	ADS-209	ADS-207	ADS-207	ADS-207	ADS-207	ADS-207	ADS-207
Voltage ranges	120/240	120/240	120/208	120/240	277/480	347/600	127/220
Voltage feature code	R104-2	R104-2	R098-2	R106-2	R002-2	R114-2	R020-2
Surge kW	112.4	111.6	116.1	116.1	117.5	117.5	116.7
Motor starting kVA (at 90% sustained voltage) Shunt			360	360	360	360	360
Motor starting kVA (at 90% sustained voltage) PMG			423	423	423	423	423
Full load current amps at standby rating	417	417	347	301	150	120	328

Alternator data

Standard Alternators	Single phase ²	Three phase ¹				
Maximum temperature rise above 40 °C ambient	105 °C	105 °C	105 °C	105 °C	105 °C	105 °C
Feature code	BB91-2	BB93-2	BB94-2	BB95-2	BB92-2	BB85-2
Alternator data sheet number	ADS-208	ADS-208	ADS-208	ADS-207	ADS-207	ADS-207
Voltage ranges	120/240	120/208	120/240	277/480	347/600	127/220
Voltage feature code	R104-2	R098-2	R106-2	R002-2	R114-2	R020-2
Surge kW	113.2	118.1	118.1	117.5	117.5	116.7
Motor starting kVA (at 90% sustained voltage) Shunt		422	422	360	360	360
Motor starting kVA (at 90% sustained voltage) PMG		497	497	423	423	423
Full load current amps at standby rating	417	347	301	150	120	328

Notes:

¹ Single phase power can be taken from a three phase generator set at up to 2/3 set rated 3-phase kW at 1.0 power factor

² Full single phase output up to full set rated 3-phase kW at 1.0 power factor

³ Reconnectable option

Formulas for calculating full load currents:

$$\frac{\text{Three phase output}}{\text{Voltage} \times 1.73 \times 0.8} = \frac{\text{Single phase output}}{\text{Voltage}}$$

$$\frac{\text{kW} \times 1000}{\text{Voltage} \times 1.73 \times 0.8} = \frac{\text{kW} \times \text{SinglePhaseFactor} \times 1000}{\text{Voltage}}$$

Warning: Back feed to a utility system can cause electrocution and/or property damage. Do not connect to any building's electrical system except through an approved device or after building main switch is open.

North America
1400 73rd Avenue N.E.
Minneapolis, MN 55432
USA

Phone 763 574 5000
 Fax 763 574 5298

Our energy working for you.™

©2018 Cummins Inc. All rights reserved.
 Cummins is a registered trademarks of Cummins Inc. PowerCommand, AmpSentry, InPower and "Our energy working for you." are trademarks of Cummins. Other company, product, or service names may be trademarks or service marks of others. Specifications are subject to change without notice.
 NAD-6336-EN (03/18) A059X437



power.cummins.com



PowerCommand[®]

1.1 Control System



Description

The PowerCommand control system is a microprocessor-based generator set monitoring, metering and control system designed to meet the demands of today's engine driven generator sets. The integration of all control functions into a single control system provides enhanced reliability and performance compared to conventional generator set control systems. These control systems have been designed and tested to meet the harsh environment in which gensets are typically applied.

Features

Easy to view: HMI 211RS for residential use. 128 x 64 pixel graphic LED backlight LCD.

Easy to use: Tactile buttons for generator set start/stop. Residential Standby display for convenient use.

Modbus[®] interface: Eliminates need for MODLON.

Progressive protective functions: Advanced Overcurrent Protection – Generator set monitoring & protection.

Digital voltage regulation: Single phase full wave SCR type regulator compatible with either shunt or PMSG systems.

Digital engine speed governing: Provides isochronous frequency regulation.

12 and 24 VDC battery operation.

Automatic mains failure: Smooth & automatic transfer and re-transfer of load from utility to generator set & vice-versa.

Exerciser clock: Runs generator set exerciser routines for dependability of operation.

Warranty and service: Backed by a comprehensive warranty and worldwide distributor service network.

Certification: Suitable for use on generator sets that are designed, manufactured, tested and certified to relevant UL, NFPA, ISO, IEC Mil Std., CE and CSA standards.

PowerCommand Digital Generator Set Control PCC 1302

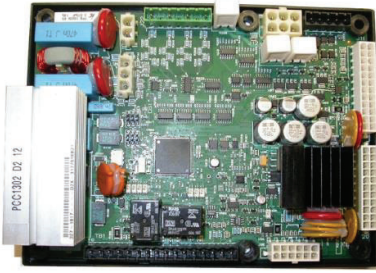

Description

The PowerCommand generator set control is suitable for use on a wide range of generator sets in non-paralleling applications. The PowerCommand control is compatible with shunt or PMG excitation style. It is suitable for use with reconnectable or non-reconnectable generators, and it can be configured for any frequency, voltage and power connection from 120-600 VAC Line-to-Line.

Power for this control system is derived from the generator set starting batteries. The control functions over a voltage range from 8 VDC to 30 VDC.

Features

- 12 and 24 VDC battery operation.
- Digital voltage regulation.
- Digital engine speed governing (where applicable) - Provides isochronous frequency regulation.
- Full authority engine communications (where applicable) - Provides communication and control with the Engine Control Module (ECM).
- Common harnessing - with higher feature Cummins controls allows for easy field upgrades.
- Generator set monitoring - Monitors status of all critical engine and alternator functions.
- Digital genset metering (AC and DC).
- Genset battery monitoring system - to sense and warn against a weak battery condition.
- Engine starting - Includes relay drivers for starter, fuel shut off (FSO), glow plug/spark ignition power and switch B+ applications.
- Generator set protection - Protects engine and alternator.
- Advanced serviceability - using InPower™, a PC-based software service tool.
- Environmental protection - The control system is designed for reliable operation in harsh environments. The main control board is a fully encapsulated module that is protected from the elements.
- Exerciser function – Routine exercising of generator set.
- Supports dual fuel control.
- Automatic Mains Failure function built in generator set controller. Modbus interface - for interconnecting to customer equipment.

- Configurable inputs and outputs - Four discrete inputs and two dry contact relay outputs.
- Warranty and service - Backed by a comprehensive warranty and worldwide distributor service network.
- Certifications - Suitable for use on generator sets that are designed, manufactured, tested and certified to relevant UL, NFPA, ISO, IEC, Mil Std., CE and CSA standards.

Base Control Functions

HMI capability

Operator adjustments - The HMI includes provisions for many set up and adjustment functions.

Generator set hardware data - Access to the control and software part number, generator set rating in kVA and generator set model number is provided from the HMI or InPower™.

Data logs - Includes engine run time, controller on time, number of start attempts.

Fault history - Provides a record of the most recent fault conditions with control hours time stamp. Up to 10 events are stored in the control non-volatile memory.

Alternator data

- Voltage (single or three phase Line-to-Line and Line-to-Neutral)
- Current (single or three phase)
- kVA (three phase and total)
- Frequency
- Engine data
- Starting battery voltage
- Engine speed
- Engine temperature
- Engine oil pressure
- Partial Full Authority Engine (FAE) data (where applicable)
- Service adjustments - The HMI includes provisions for adjustment and calibration of generator set control functions. Adjustments are protected by a password. Functions include:
 - Engine speed governor adjustments
 - Voltage regulation adjustments
 - Cycle cranking
 - Configurable fault set up
 - Configurable output set up
 - Meter calibration
 - Units of measurement

Engine control

SAE-J1939 CAN interface to full authority ECMs (where applicable) - Provides data swapping between genset and engine controller for control, metering and diagnostics.

12 VDC/24 VDC battery operations - PowerCommand will operate either on 12 VDC or 24 VDC batteries.

Isochronous governing (where applicable) - Capable of controlling engine speed within +/-0.25% for any steady state load from no load to full load. Frequency drift will not exceed +/-0.5% for a 33 °C (60 °F) change in ambient temperature over an 8 hour period.

Temperature dependent governing dynamics (with electronic governing) - Modifies the engine governing control parameters as a function of engine temperature. This allows the engine to be more responsive when warm and more stable when operating at lower temperature levels.

Remote start mode - Accepts a ground signal from remote devices to automatically start the generator set and immediately accelerate to rated speed and voltage. The remote start signal will also wake up the control from sleep mode. The control can incorporate a time delay start and stop.

Remote and local Emergency stop - The control accepts a ground signal from a local (genset mounted) or remote (facility mounted) Emergency stop switch to cause the generator set to immediately shut down. The generator set is prevented from running or cranking with the switch engaged. If in sleep mode, activation of either Emergency stop switch will wake up the control.

Sleep mode - The control includes a configurable low current draw state to minimize starting battery current draw when the genset is not operating. The control can also be configured to go into a low current state while in auto for Prime applications or applications without a battery charger.

Engine starting - The control system supports automatic engine starting. Primary and backup start disconnects are achieved by one of three methods: magnetic pickup, battery charging alternator feedback or main alternator output frequency. The control also supports configurable glow plug control when applicable.

Cycle cranking - Configurable for the number of starting cycles (1 to 7) and duration of crank and rest periods. Control includes starter protection algorithms to prevent the operator from specifying a starting sequence that might be damaging.

Time delay start and stop (cooldown) - Configurable for time delay of 0-300 seconds prior to starting after receiving a remote start signal and for time delay of 0-600 seconds prior to shut down after signal to stop in normal operation modes. Default for both time delay periods is 0 seconds.

Alternator control

The control includes an integrated line-to-line sensing voltage regulation system that is compatible with shunt or PMG excitation systems. The voltage regulation system is full wave rectified and has an SCR output for good motor starting capability. Major system features include:

Digital output voltage regulation - Capable of regulating output voltage to within +/-1.0% for any loads between no load and full load. Voltage drift will not exceed +/-1.5% for a 40 °C (104 °F) change in temperature in an eight hour period. On engine starting or sudden load acceptance, voltage is controlled to a maximum of 5% overshoot over nominal level.

The automatic voltage regulator feature can be disabled to allow the use of an external voltage regulator.

Torque-matched V/Hz overload control - The voltage roll-off set point and rate of decay (i.e. the slope of the V/Hz curve) is adjustable in the control.

Protective Functions

On operation of a protective function the control will indicate a fault by illuminating the appropriate status LED on the HMI, as well as display the fault code and fault description on the LCD. The nature of the fault and time of occurrence are logged in the control. The service manual and InPower service tool provide service keys and procedures based on the service codes provided. Protective functions include:

Battle short mode

When enabled and the battle short switch is active, the control will allow some shutdown faults to be bypassed. If a bypassed shutdown fault occurs, the fault code and description will still be annunciated, but the genset will not shutdown. This will be followed by a fail to shutdown fault. Emergency stop shutdowns and others that are critical for proper operation are not bypassed. Please refer to the Control Application Guide or Manual for list of these faults.

Configurable alarm and status inputs

The control accepts up to four alarm or status inputs (configurable contact closed to ground or open) to indicate a configurable (customer-specified) condition. The control is programmable for warning, shutdown or status indication and for labelling the input.

Emergency stop

Annunciated whenever either Emergency stop signal is received from external switch.

General engine protection

Low and high battery voltage warning - Indicates status of battery charging system (failure) by continuously monitoring battery voltage.

Weak battery warning - The control system will test the battery each time the generator set is signaled to start and indicate a warning if the battery indicates impending failure.

Fail to start (overcrank) shutdown - The control system will indicate a fault if the generator set fails to start by the completion of the engine crank sequence.

Fail to crank shutdown - Control has signaled starter to crank engine but engine does not rotate.

Cranking lockout - The control will not allow the starter to attempt to engage or to crank the engine when the engine is rotating.

Hydro mechanical fuel system engine protection

Overspeed shutdown - Default setting is 115% of nominal.

Low lube oil pressure warning/shutdown - Level is pre-set (configurable with InPower) to match the capabilities of the engine used. Control includes time delays to prevent nuisance alarms.

High lube oil temperature warning/shutdown - Level is pre-set (configurable with InPower) to match the capabilities of the engine used. Control includes time delays to prevent nuisance alarms.

High engine temperature warning/shutdown - Level is pre-set (configurable with InPower) to match the capabilities of the engine used. Control includes time delays to prevent nuisance alarms.

Low coolant temperature warning - Indicates that engine temperature may not be high enough for a 10 second start or proper load acceptance.

Sensor failure indication - Logic is provided on the base control to detect analog sensor or interconnecting wiring failures.

Full authority electronic engine protection

Engine fault detection is handled inside the engine ECM. Fault information is communicated via the SAE-J1939 data link for annunciation in the HMI

Alternator protection

High AC voltage shutdown (59) - Output voltage on any phase exceeds pre-set values. Time to trip is inversely proportional to amount above threshold. Values adjustable from 105-130% of nominal voltage, with time delay adjustable from 0.1-10 seconds. Default value is 110% for 10 seconds.

Low AC voltage shutdown (27) - Voltage on any phase has dropped below a pre-set value. Adjustable over a range of 50-95% of reference voltage, time delay 2-20 seconds. Default value is 85% for 10 seconds.

Overcurrent warning/shutdown - Implementation of the thermal damage curve with instantaneous trip level calculated based on current transformer ratio and application power rating.

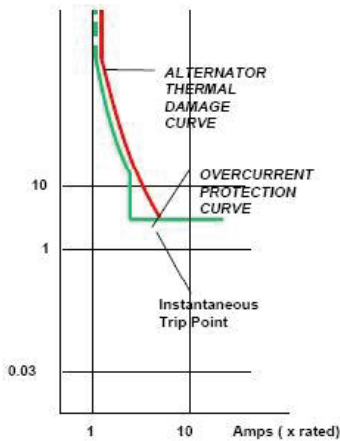

Under frequency shutdown (81 u) - Generator set output frequency cannot be maintained. Settings are adjustable from 2-10 Hz below nominal governor set point, for a 5-20 second time delay. Default: 6 Hz, 10 seconds.

Over frequency shutdown/warning (81o) - Generator set is operating at a potentially damaging frequency level. Settings are adjustable from 2-10 Hz above nominal governor set point for a 1-20 second time delay. Default: 6 Hz, 10 seconds, enabled.

Loss of sensing voltage shutdown - Shutdown of generator set will occur on loss of voltage sensing inputs to the control.

Field overload shutdown - Uses field voltage to shutdown generator set when a field overload condition occurs.

Advanced Functions

Automatic mains failure*

The built in AMF feature provides the automatic transfer and re-transfer of the load from utility to generator set and vice-versa.

- Automatically starts-stops the generator set in the event of utility failure.
- Annunciates faults.

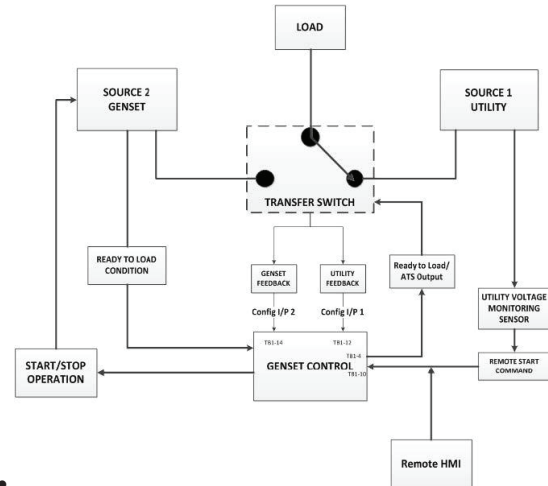

- * A utility voltage monitoring sensor (as shown in the AMF diagram above) must be connected in order to use the AMF feature on the 1302 control. Use Schneider Electric Relay RSB1A120U7 and Socket RSZE1S35M.

Exerciser clock

The exerciser clock runs the generator set exerciser routines for dependability of operation.

Field Control Interface

Input signals to the base control include:

- Remote start
- Local and Emergency stop
- Configurable inputs: Control includes (4) input signals from customer discrete devices that are configurable for warning, shutdown or status indication, as well as message displayed.

Output signals from the PowerCommand control include:

- Configurable relay outputs: Control includes (2) relay output contacts rated at 2 A. These outputs can be configured to activate on any control warning or shutdown fault as well as ready to load, not in auto, common alarm, common warning and common shutdown.
- Ready to load (generator set running) signal: Operates when the generator set has reached 90% of rated speed and voltage and latches until generator set is switched to off or idle mode.

PowerCommand Human Machine Interface HMI211



Description

This control system includes an intuitive operator interface panel that allows for complete genset control as well as system metering, fault annunciation, configuration and diagnostics. The interface includes five generator set status LED lamps with both internationally accepted symbols and English text to comply with customer needs. The interface also includes an LED backlit LCD display with tactile feel soft-switches for easy operation and screen navigation. It is configurable for units of measurement and has adjustable screen contrast and brightness.

The *run/off/auto* switch function is integrated into the interface panel.

All data on the control can be viewed by scrolling through screens with the navigation keys. The control displays the current active fault and a time-ordered history of the five previous faults.

Features

- LED indicating lamps:
 - Remote start
 - Not in auto
 - Shutdown
 - Warning
 - Auto
 - Run
- 128 x 64 pixels graphic LED backlight LCD.
- Four tactile feel membrane switches for LCD defined operation. The functions of these switches are defined dynamically on the LCD.
- Two tactile feel membrane switches dedicated for off and back.
- Allows for complete genset control setup.
- Certifications: Suitable for use on generator sets that are designed, manufactured, tested and certified to relevant UL, NFPA, ISO, IEC, Mil Std., CE and CSA standards.
- HMI 211RS provides convenience for residential use.

Communications Connections

PC tool interface - This RS-485 communication port allows the HMI to communicate with a personal computer running InPower.

This RS-485 communication port allows the HMI to communicate with the main control board.

Mechanical Drawing

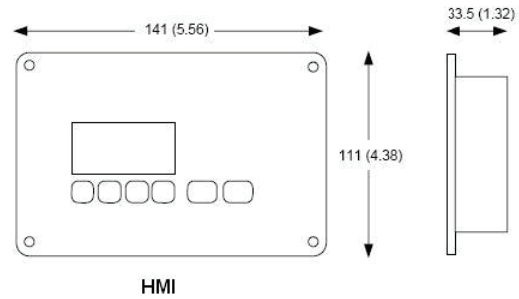

Dimensions: mm (inches)

Software

InPower (beyond 6.0 version) is a PC-based software service tool that is designed to directly communicate to PowerCommand generator sets and transfer switches, to facilitate service and monitoring of these products.

Environment

The control is designed for proper operation without recalibration in ambient temperatures from -40 °C (-40 °F) to +70 °C (158 °F), and for storage from -55 °C (-67 °F) to +80 °C (176 °F). Control will operate with humidity up to 95%, non-condensing.

The HMI is designed for proper operation in ambient temperatures from -40 °C* (-40 °F) to +70 °C (158 °F), and for storage from -40 °C* (-40 °F) to +80 °C (176 °F).

The control board is fully encapsulated to provide superior resistance to dust and moisture. Display panel has a single membrane surface, which is impervious to effects of dust, moisture, oil and exhaust fumes. This panel uses a sealed membrane to provide long reliable service life in harsh environments.

The control system is specifically designed and tested for resistance to RFI/EMI and to resist effects of vibration to provide a long reliable life when mounted on a generator set. The control includes transient voltage surge suppression to provide compliance to referenced standards.

* Heater accessory (pn: A040H853) is available for enhanced operation below -20 °C

Certifications

PowerCommand meets or exceeds the requirements of the following codes and standards:

- NFPA 110 for level 1 and 2 systems.
- ISO 8528-4: 1993 compliance, controls and switchgear.
- CE marking: The control system is suitable for use on generator sets to be CE-marked.
- EN 50081-1,2 residential/light industrial emissions or industrial emissions.
- EN 50082-1,2 residential/light industrial or industrial susceptibility.
- ISO 7637-2, level 2; DC supply surge voltage test.
- Mil Std. 202C, Method 101 and ASTM B117: Salt fog test.
- PowerCommand control systems and generator sets are designed and manufactured in ISO 9001 certified facilities.
- UL 6200 recognized and suitable for use on UL 2200 Listed generator sets.
- CSA C282-M1999 compliance.
- CSA 22.2 No. 14 M91 industrial controls.

Warranty

All components and subsystems are covered by an express limited one year warranty. Other optional and extended factory warranties and local distributor maintenance agreements are available

Accessories

1301-1302 Upgrade Kit (HM)	0541-1431
PowerCommand 500 (LAN)	A040X126
Remote HMI 211	0541-1394
Remote HMI 211RS	A046K103
I/O Expansion (Aux 101)	0541-1291
HMI Heater Accessory Kit	A040H853

Parts Ordering Information

1302 Control Board	0327-1617-02
1302 control Board – Arrow	A043W505
Aux 104 (Governor Control)	0327-1507
HMI 211 Without Heater	0300-6014
HMI 211 with Heater	A026G237

Additional Resources

Resource	Where to find
1302 Service Manual	QSOL
Accessories Catalog	cumminspower.com
Additional Controls Information	PowerSuite Library



For more information contact your local Cummins distributor or visit power.cummins.com

Our energy working for you.™





Alternator data sheet

Frame size: **UC3D**

Characteristics								
Weights:		Wound stator assembly:	265 lb	120 kg				
		Rotor assembly:	317 lb	144 kg				
		Complete alternator:	941 lb	427 kg				
Maximum speed:			2250 rpm					
Excitation current:		Full load:	2 Amps					
		No load:	0.5 Amps					
Insulation system:		Class H throughout						
1 ∅ Ratings (1.0 power factor)		60 Hz				50 Hz		
(Based on specific temperature rise at 40 °C ambient temperature)		Double delta		4 lead		Double delta		
		<u>120/240</u>		<u>120/240</u>		110-120 <u>220-240</u>		
125 °C rise ratings	kW/kVA	78/78		100/100		68/68		
105 °C rise ratings	kW/kVA	72/72		87/87		60/60		
3 ∅ Ratings (0.8 power factor)		Upper broad range		LBR*	347/600	Broad range		
(Based on specified temperature rise at 40 °C ambient temperature)		<u>120/208</u>	<u>139/240</u>	<u>190-208</u>		<u>110/190</u>	<u>120/208</u>	<u>127/220</u>
		<u>240/416</u>	<u>277/480</u>	<u>380-416</u>	<u>347/600</u>	<u>220/380</u>	<u>240/415</u>	<u>254/440</u>
150 °C Rise ratings	kW	110	124	110	124	97	97	92
	kVA	138	155	138	155	121	121	116
125 °C Rise ratings	kW	105	117	105	117	91	91	87
	kVA	131	146	131	146	114	114	109
105 °C Rise ratings	kW	96	105	96	105	80	80	74
	kVA	120	131	120	131	100	100	93
80 °C Rise ratings	kW	80	88	80	88	72	72	67
	kVA	100	110	100	110	90	90	84
3 ∅ Reactances (per unit, ±10%)								
(Based on full load at 105 °C rise rating)								
Synchronous		2.53	2.08	2.00	1.82	2.11	1.77	1.46
Transient		0.21	0.17	0.16	0.16	0.18	0.15	0.12
Subtransient		0.14	0.12	0.12	0.12	0.13	0.11	0.09
Negative sequence		0.17	0.14	0.14	0.14	0.14	0.11	0.09
Zero sequence		0.10	0.08	0.08	0.08	0.08	0.07	0.06
3 ∅ Motor starting								
Maximum kVA	(Shunt)	360	360	360		244		
(90% sustained voltage)	(PMG)	423	423	423		306		
Time constants (Sec)								
Transient		0.030	0.030	0.030		0.030		
Subtransient		0.010	0.010	0.010		0.010		
Open circuit		0.820	0.820	0.820		0.820		
DC		0.007	0.007	0.007		0.007		



Alternator data sheet

Frame size: **UC3D**

Windings	(@ 20 °C)				
Stator resistance	(Line to Line, Ohms)	0.0900	0.0680	0.1250	0.0900
Rotor resistance	(Ohms)	1.2000	1.2000	1.2000	1.2000
Number of leads		12	12	6	12

* Lower broad range 110/190 thru 120/208, 220/380 thru 240/416.



Prototype Test Supported Emergency/Standby Generator Sets Certification

Cummins Power Generation certifies that its commercial generator sets bearing the Prototype Test Supported (PTS) seal have been subjected to a design and development process that includes extensive prototype testing and evaluation. A PTS production model is engineered and manufactured according to documentation developed through comprehensive research, design and design verification.

Design verification is based on tests of preproduction prototype models manufactured specifically for prototype test purposes and not sold as new equipment. To be certified as a PTS model, the generator set must satisfy these prerequisites:

DESIGN - The PTS certified generator set must be designed specifically for emergency/standby applications that require high reliability and rapid response.

PROTOTYPE TESTING - Design suitability of the PTS certified generator set must be proven by tests on preproduction prototype models. The prototype test program is intended to:

1. Confirm the engine and generator have reserve capacity beyond rating to minimize the potential of damage or shutdown during steady state or transient loading conditions, including momentary overloads.
2. Demonstrate generator set, controls and accessories capability to perform reliably and compatibly in service during disturbances common in actual load circuits.
3. Verify the integrity of the generator and excitation system insulation systems and electrical components to withstand heating under rated load and transient overcurrent conditions.
4. Evaluate generator set mechanical and electrical strength to perform without damage during abnormal operating conditions, such as short circuits or out-of-phase paralleling. While operating at rated load, the generator set must be subjected to several 3-phase short circuits of 20 second duration. After the tests, the generator set is inspected to verify that no electrical or mechanical damage was incurred by any components.
5. Determine by endurance testing that no resonance conditions exist in the generator set or accessories that will cause premature failure of components on production units.
6. Investigate and identify failure modes to minimize the risk of any single component failure or human error that could lead to lack of essential electrical supply.
7. Provide a margin of safety, by actual trials, between the generator set component design and protection systems so that the components are not damaged before the protective devices activate a shutdown.

DOCUMENTATION AND SOFTWARE - The PTS certified generator set must be documented in a single drawing package with all components identified with Cummins Power Generation part numbers. A PTS test certificate must be created for each PTS generator set certifying the PTS testing performed.

QUALITY ASSURANCE - Engineering drawings, specifications and test requirements for a PTS certified generator set must be classified by components and assembly quality characteristics. A component and process inspection and test plan must be developed and maintained to measure product conformance to documentation requirements.

PRODUCTION MODEL TESTING - PTS certified generator sets must be subjected to complete production tests that demonstrate conformance to specifications at all rated conditions, including start-up, full load pickup and a performance run at full rated load and power factor.



Prototype Test Support (PTS) 60 Hz test summary



<u>Generator set models</u>		<u>Representative prototype</u>	
C50D6C	C80D6C	Model:	C100D6C
C60D6C	C100D6C	Alternator:	UC27 D
		Engine:	QSB5-G5

The following summarizes prototype testing conducted on the designated representative prototype of the specified models. This testing is conducted to verify the complete generator set electrical and mechanical design integrity. Prototype testing is conducted only on generator sets not sold as new equipment.

Maximum surge power: 117.5 kW

The generator set was evaluated to determine the stated maximum surge power.

Maximum motor starting: 146.3 kVA

The generator set was tested to simulate motor starting by applying the specified kVA load at low lagging power factor (0.4 or lower). With this load applied, the generator set recovered to a minimum of 90% rated voltage.

Alternator temperature rise:

The highest rated temperature rise (120 °C) test results are reported as follows to verify that worst case temperature rises do not exceed allowable NEMA MG1 limits for class H insulation. Tests were conducted per IEEE 115, rise by resistance and embedded detector, with the rated voltages. Only the highest temperatures are reported.

<u>Location</u>	<u>Maximum rise (°C)</u>
Alternator stator	N/A
Alternator rotor	N/A
Exciter stator	N/A
Exciter rotor	N/A

Torsional analysis and testing:

The generator set was tested to verify that the design is not subjected to harmful torsional stresses. A spectrum analysis of the transducer output was conducted.

Cooling system: 50 °C ambient
0.5 in. H₂O restriction

The cooling system was tested to determine ambient temperature and static restriction capabilities. The test was performed at full rated load in elevated ambient temperature under static restriction conditions.

Durability:

The C100D6C generator set was subjected to a minimum 500 hour endurance test operating at variable load up to the Standby rating based upon MIL-STD-705 to verify structural soundness and durability of the design.

Electrical and mechanical strength:

The generator set was tested to several single phase and three phase faults to verify that the generator can safely withstand the forces associated with short circuit conditions. The generator set was capable of producing full rated output at the conclusion of the testing.

Steady state performance:

The generator set was tested to verify if the steady state operating performance was within the specified maximum limits.

Voltage regulation:	± 1%
Random voltage variation:	± 1%
Frequency regulation:	± Isochronous
Random frequency variation:	± 0.5%

Transient performance:

The generator set was tested to verify single step loading capability as required by NFPA 110 and verify acceptable voltage and frequency response on load addition or rejection. The following results were recorded at 1.0 power factor:

Full load acceptance:

Voltage dip:	28%
Recovery time:	1.3 seconds
Frequency dip:	9.1%
Recovery time:	2.6 seconds

Full load rejection:

Voltage rise:	20.2%
Recovery time:	0.6 seconds
Frequency rise:	7.0%
Recovery time:	1.7 seconds

Harmonic analysis:

(per MIL-STD-705B, method 601.4)

<u>Harmonic</u>	<u>Line to Line</u>		<u>Line to Neutral</u>	
	<u>No load</u>	<u>Full load</u>	<u>No load</u>	<u>Full load</u>
3	0.04	0.15	0.15	0.15
5	0.2	0.2	0.2	0.2
7	0.6	0.6	0.6	0.6
9	0.02	0.04	0.04	0.04
11	0.52	0.52	0.52	0.52
13	0.26	0.26	0.26	0.26
15	0.0	0.0	0.0	0.0

1 2 3 4 5 6

REV	DATE	BY	CHKD	DESCRIPTION
1	01/11/16	WAS	WAS	WAS 1/16"
2	02/01/16	WAS	WAS	WAS 1/16"

NOTES:

- DIMENSIONS SHOWN IN () ARE IN INCHES.
- REFER TO CIRCUIT BREAKER OUTLINE DRAWING FOR ELECTRICAL STUB-UP AREA FOR SPECIFIC BREAKERS.
- CONTROL INTERFACE CONNECTION SHOULD BE MADE WITH FLEXIBLE CONNECTIONS.
- Δ Ø 21 (0.81) HOLES MARKED BY Δ FOR SECURING TO MOUNTING SURFACE.
- OIL DRAIN EXTENSION: 5/8 INCH HOSE ID.
- FOR IBC SEISMIC CERTIFIED INSTALLATION, SEE GENSET IBC SEISMIC INSTALLATION REQUIREMENT DRAWING.
- Δ Ø 7.3 HOLES FOR OPTIONAL COOLING EXHAUST AIR DUCT ADAPTER.
- REFER TO GENSET FOUNDATION OUTLINE FOR ELECTRICAL AND OTHER FOUNDATION SPECIFICS.
- GENSET SUPPLIED WITH FLEXIBLE FUEL LINE(S) THAT CAN BE CONNECTED TO GENSET INTERFACE POINT(S).
- FUEL SUPPLY LINE: 686 (27.0) LONG WITH 5/16" JIC MALE TERMINATION.

ALT DATA SHEET #	DIM A	DIM B	GENSET NET WEIGHT	
			KG	LB
ADS-202	1092	456	1090	2403
ADS-203	1207	495	986	2173
ADS-204	1184	492	1006	2217
ADS-205	1125	486	1054	2324
ADS-206	1086	482	1082	2386
ADS-207	1060	480	1106	2439
ADS-208	998	473	1173	2586
ADS-209	958	469	1211	2670

add this weight to the enclosure and fuel tank weights for overall shipping weight.
 Use the enclosure and fuel tank drawings for overall shipping dimensions.

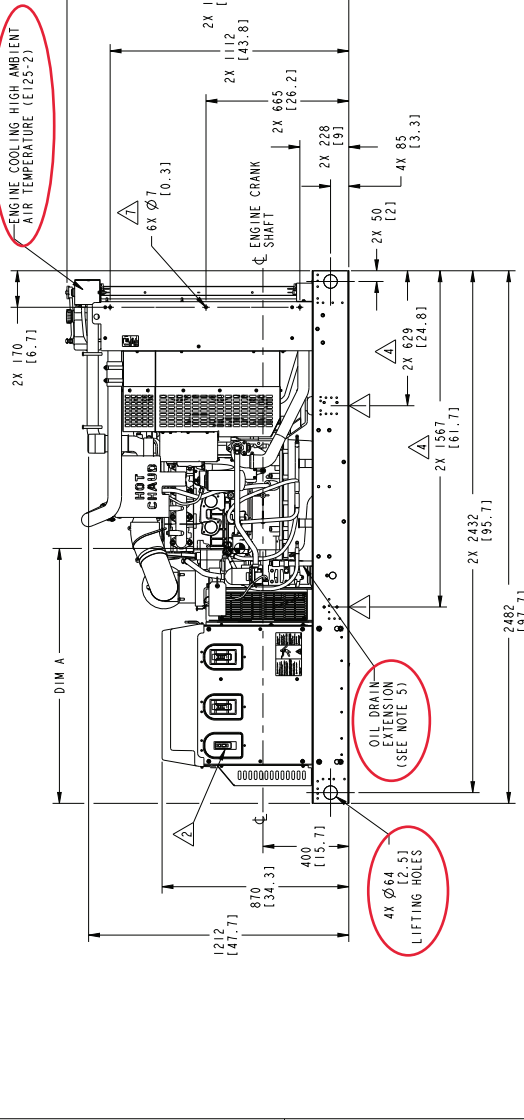
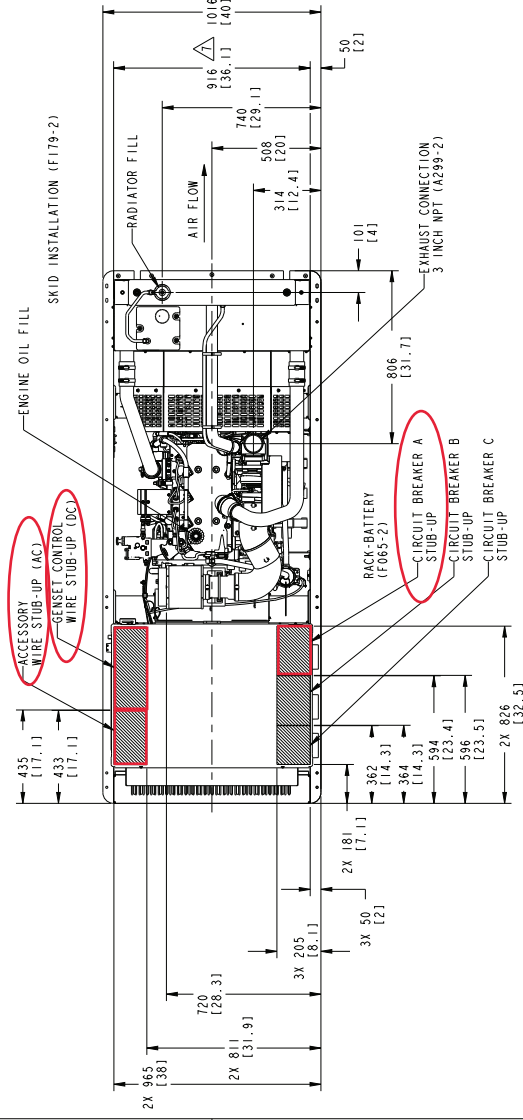

C50 D6C, C60 D6C, C80 D6C,
 C100 D6C, C125 D6C

UNLESS OTHERWISE SPECIFIED, ALL DIMENSIONS ARE IN MILLIMETERS	SCALE: 1:1	DATE: 01/11/16	BY: WAS	CHKD: WAS
0.00-4.99	±0.15	01/11/16	WAS	WAS
5.00-24.99	±0.25	02/01/16	WAS	WAS
25.00-49.99	±0.30	02/01/16	WAS	WAS
50.00-99.99	±0.35	02/01/16	WAS	WAS
100.00-149.99	±0.40	02/01/16	WAS	WAS
150.00-199.99	±0.45	02/01/16	WAS	WAS
200.00-249.99	±0.50	02/01/16	WAS	WAS
250.00-299.99	±0.55	02/01/16	WAS	WAS
300.00-349.99	±0.60	02/01/16	WAS	WAS
350.00-399.99	±0.65	02/01/16	WAS	WAS
400.00-449.99	±0.70	02/01/16	WAS	WAS
450.00-499.99	±0.75	02/01/16	WAS	WAS
500.00-549.99	±0.80	02/01/16	WAS	WAS
550.00-599.99	±0.85	02/01/16	WAS	WAS
600.00-649.99	±0.90	02/01/16	WAS	WAS
650.00-699.99	±0.95	02/01/16	WAS	WAS
700.00-749.99	±1.00	02/01/16	WAS	WAS
750.00-799.99	±1.05	02/01/16	WAS	WAS
800.00-849.99	±1.10	02/01/16	WAS	WAS
850.00-899.99	±1.15	02/01/16	WAS	WAS
900.00-949.99	±1.20	02/01/16	WAS	WAS
950.00-999.99	±1.25	02/01/16	WAS	WAS
1000.00-1049.99	±1.30	02/01/16	WAS	WAS
1050.00-1099.99	±1.35	02/01/16	WAS	WAS
1100.00-1149.99	±1.40	02/01/16	WAS	WAS
1150.00-1199.99	±1.45	02/01/16	WAS	WAS
1200.00-1249.99	±1.50	02/01/16	WAS	WAS
1250.00-1299.99	±1.55	02/01/16	WAS	WAS
1300.00-1349.99	±1.60	02/01/16	WAS	WAS
1350.00-1399.99	±1.65	02/01/16	WAS	WAS
1400.00-1449.99	±1.70	02/01/16	WAS	WAS
1450.00-1499.99	±1.75	02/01/16	WAS	WAS
1500.00-1549.99	±1.80	02/01/16	WAS	WAS
1550.00-1599.99	±1.85	02/01/16	WAS	WAS
1600.00-1649.99	±1.90	02/01/16	WAS	WAS
1650.00-1699.99	±1.95	02/01/16	WAS	WAS
1700.00-1749.99	±2.00	02/01/16	WAS	WAS
1750.00-1799.99	±2.05	02/01/16	WAS	WAS
1800.00-1849.99	±2.10	02/01/16	WAS	WAS
1850.00-1899.99	±2.15	02/01/16	WAS	WAS
1900.00-1949.99	±2.20	02/01/16	WAS	WAS
1950.00-1999.99	±2.25	02/01/16	WAS	WAS
2000.00-2049.99	±2.30	02/01/16	WAS	WAS
2050.00-2099.99	±2.35	02/01/16	WAS	WAS
2100.00-2149.99	±2.40	02/01/16	WAS	WAS
2150.00-2199.99	±2.45	02/01/16	WAS	WAS
2200.00-2249.99	±2.50	02/01/16	WAS	WAS
2250.00-2299.99	±2.55	02/01/16	WAS	WAS
2300.00-2349.99	±2.60	02/01/16	WAS	WAS
2350.00-2399.99	±2.65	02/01/16	WAS	WAS
2400.00-2449.99	±2.70	02/01/16	WAS	WAS
2450.00-2499.99	±2.75	02/01/16	WAS	WAS
2500.00-2549.99	±2.80	02/01/16	WAS	WAS
2550.00-2599.99	±2.85	02/01/16	WAS	WAS
2600.00-2649.99	±2.90	02/01/16	WAS	WAS
2650.00-2699.99	±2.95	02/01/16	WAS	WAS
2700.00-2749.99	±3.00	02/01/16	WAS	WAS
2750.00-2799.99	±3.05	02/01/16	WAS	WAS
2800.00-2849.99	±3.10	02/01/16	WAS	WAS
2850.00-2899.99	±3.15	02/01/16	WAS	WAS
2900.00-2949.99	±3.20	02/01/16	WAS	WAS
2950.00-2999.99	±3.25	02/01/16	WAS	WAS
3000.00-3049.99	±3.30	02/01/16	WAS	WAS

REV. NO.	REV. DATE	DESCRIPTION	BY	CHK.	DATE
ECO-178354	02	ENGINE C-3; 5/16" WAS 1/4"	CP/TPE	M/ROBE	07/26/08

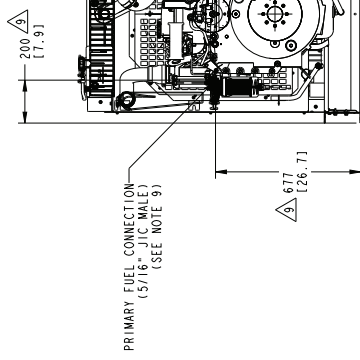
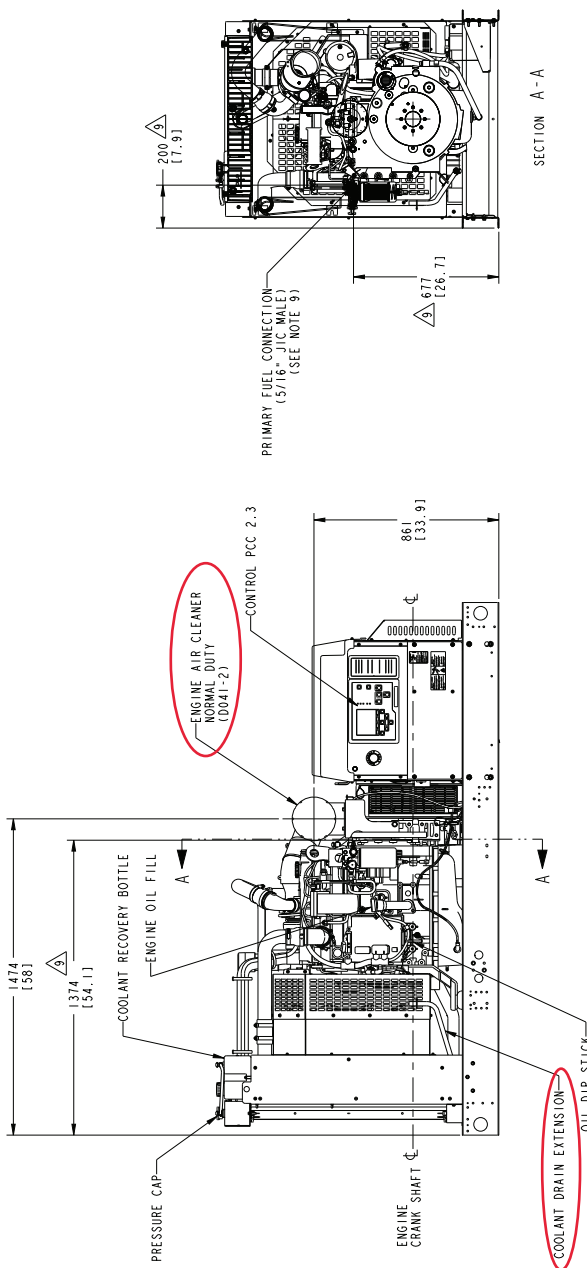

SECTION A-A

C50 D6C, C60 D6C, C80 D6C,
C100 D6C, C125 D6C

UNLESS OTHERWISE SPECIFIED, ALL DIMENSIONS ARE IN MILLIMETERS		DESIGN SCALE	AS SHOWN
1:1	0.00-4.99	1:1	AS SHOWN
2:1	5.00-24.99	2:1	AS SHOWN
3:1	25.00-49.99	3:1	AS SHOWN
4:1	50.00-99.99	4:1	AS SHOWN
5:1	100.00-149.99	5:1	AS SHOWN
6:1	150.00-199.99	6:1	AS SHOWN
7:1	200.00-249.99	7:1	AS SHOWN
8:1	250.00-299.99	8:1	AS SHOWN
9:1	300.00-349.99	9:1	AS SHOWN
10:1	350.00-399.99	10:1	AS SHOWN
12:1	400.00-499.99	12:1	AS SHOWN
15:1	500.00-999.99	15:1	AS SHOWN
20:1	1000.00-1499.99	20:1	AS SHOWN
25:1	1500.00-2499.99	25:1	AS SHOWN
30:1	2500.00-2999.99	30:1	AS SHOWN
40:1	3000.00-3999.99	40:1	AS SHOWN
50:1	4000.00-9999.99	50:1	AS SHOWN
60:1	10000.00-14999.99	60:1	AS SHOWN
80:1	15000.00-24999.99	80:1	AS SHOWN
100:1	25000.00-99999.99	100:1	AS SHOWN

DESIGNER	CHKD BY	DATE
D. HOFFMEISTER	D. HOFFMEISTER	
APP'D BY	DATE	
M. JAWALLE	07/26/08	
SCALE	DATE	
AS SHOWN	07/26/08	
PROJECT NO.	ECO-178354	
WORK CENTER	ENGINE	
PGF	D	A054Y897
CAD FILE		2 of 2

CUMMINS POWER GENERATION
OUTLINE, GENSET
SITE CODE
PGF
D
A054Y897
2 of 2



Data Sheet

Circuit Breakers

Description

This Data sheet provides circuit breaker manufacturer part numbers and specifications. The Circuit breaker box description is the rating of that breaker box installation on a Cummins Generator. Please refer to the website of the circuit breaker manufacturer for breaker specific ratings and technical information.

Applicable Models

Engine	Models					
Kubota	C10D6	C15D6	C20D6			
QJSJ2.4	C20N6	C25N6	C30N6	C30N6H	C36N6	C36N6H
	C40N6	C40N6H	C50N6H	C60N6H		
B3.3	C25D6	C30D6	C35D6	C40D6	C50D6	C60D6
QJSJ5.9G	C45N6	C50N6	C60N6	C70N6	C80N6	C100N6
QJSJ8.9G	C125N6	C150N6				
QSB5	DSFAC	DSFAD	DSFAE	C50D6C	C60D6C	C80D6C
	C100D6C	C125D6C				
QSB7	DSGAA	DSGAB	DSGAC	DSGAD	DSGAE	
		C125D6D	C150D6D	C175D6D	C200D6D	
QSL9	DSHAD	DQDAA	DQDAB	DQDAC		
QSM11	DQHAB					
QSX15	DFEJ	DFEK				

Instructions

1. Locate the circuit breaker feature code or part number and use the charts below to find the corresponding manufacturer circuit breaker catalog number.
2. Use the first letter of the circuit breaker catalog number to determine the "frame" of the breaker. If the first letter is an "N", use the second letter. Then follow the corresponding website link from the table below to find the breaker catalog number description.

Please refer to the catalog numbering systems page, which is given in the chart, to understand the nomenclature of the catalog number.

Frame	Catalog name*	Catalog number description page(s)
P	0612CT0101 http://www.schneider-electric.us/en/download/document/0612CT0101/	16-17
H, J, and L	0611CT1001 http://www.schneider-electric.us/en/download/document/0611CT1001/	8-9
Q	0734CT0201 http://www.schneider-electric.us/en/download/document/0734CT0201/	4

*The following link may also be used to search specifically by the breaker part number or for the catalog name listed above. <http://products.schneider-electric.us/technical-library/>

3. Search the catalog by using the first 3 letters of the breaker catalog number and the first 5 numbers to find information such as trip curves, accessories, and dimensional details regarding the circuit breaker.

*If the catalog number starts with "N", skip the N and begin your search with the second letter.

*If the first 3 letters are "PJP," the search will not work. You will need to start with just "PJ" and use the description pages to obtain the information you are looking for on the "PJP."

Example

After finding your circuit breaker catalog number to be "PJL36120U33EACUKMOYB," navigate to the P-frame catalog by using the link provided.

Look at pages 16-17 of the pdf catalog to find the nomenclature of the breaker.

Search the P-frame spec sheet using the search "PJL36120."

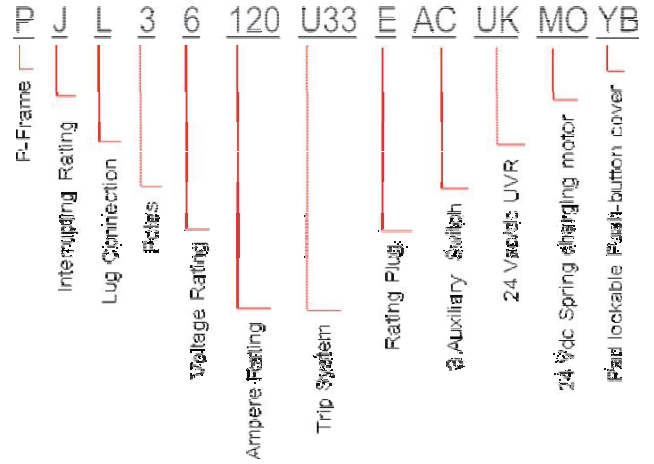

Feature Code	Breaker Box Description	Cummins Part #	Manufacturer	Breaker Catalog Number	Trip Unit	Plug Type
KV35-2	CB, Loc A, 50A, 3P, 600VAC, 80%, UL	A043L461	Schneider Electric	HDL36050	Thermal Magnetic	N/A
KV36-2	CB, Loc A, 60A, 3P, 600VAC, 80%, UL	A043L459	Schneider Electric	HDL36060	Thermal Magnetic	N/A
KV37-2	CB, Loc A, 70A, 3P, 600VAC, 80%, UL	A043L451	Schneider Electric	HDL36070	Thermal Magnetic	N/A
KV38-2	CB, Loc A, 80A, 3P, 600VAC, 80%, UL	A043L012	Schneider Electric	HDL36080	Thermal Magnetic	N/A
KV39-2	CB, Loc A, 90A, 3P, 600VAC, 80%, UL	A043K997	Schneider Electric	HDL36090	Thermal Magnetic	N/A
KV40-2	CB, Loc A, 100A, 3P, 600VAC, 80%, UL	A043L024	Schneider Electric	HDL36100	Thermal Magnetic	N/A
KV41-2	CB, Loc A, 125A, 3P, 600VAC, 80%, UL	A043K994	Schneider Electric	HDL36125	Thermal Magnetic	N/A
KV42-2	CB, Loc A, 150A, 3P, 600VAC, 80%, UL	A043K991	Schneider Electric	HDL36150	Thermal Magnetic	N/A
KV43-2	CB, Loc A, 175A, 3P, 600VAC, 80%, UL	A043L619	Schneider Electric	JDL36175	Thermal Magnetic	N/A
KV44-2	CB, Loc A, 200A, 3P, 600VAC, 80%, UL	A043L520	Schneider Electric	JDL36200	Thermal Magnetic	N/A
KV45-2	CB, Loc A, 225A, 3P, 600VAC, 80%, UL	A043L517	Schneider Electric	JDL36225	Thermal Magnetic	N/A
KV46-2	CB, Loc A, 250A, 3P, 600VAC, 80%, UL	A043L510	Schneider Electric	JDL36250	Thermal Magnetic	N/A
KV47-2	CB, Loc A, 250A, 3P, 600VAC, 100%, UL	A044C640	Schneider Electric	JDL36250U31XLC	MicroLogic 3.2S	N/A
KV55-2	CB, Loc B, 15A, 2P, 600VAC, 80%, UL	A043E189	Schneider Electric	HDL26015	Thermal Magnetic	N/A
KV57-2	CB, Loc B, 25A, 2P, 600VAC, 80%, UL	A043E191	Schneider Electric	HDL26025	Thermal Magnetic	N/A
KV58-2	CB, Loc B, 30A, 2P, 600VAC, 80%, UL	A043E185	Schneider Electric	HDL26030	Thermal Magnetic	N/A
KV59-2	CB, Loc B, 40A, 2P, 600VAC, 80%, UL	A043E183	Schneider Electric	HDL26040	Thermal Magnetic	N/A

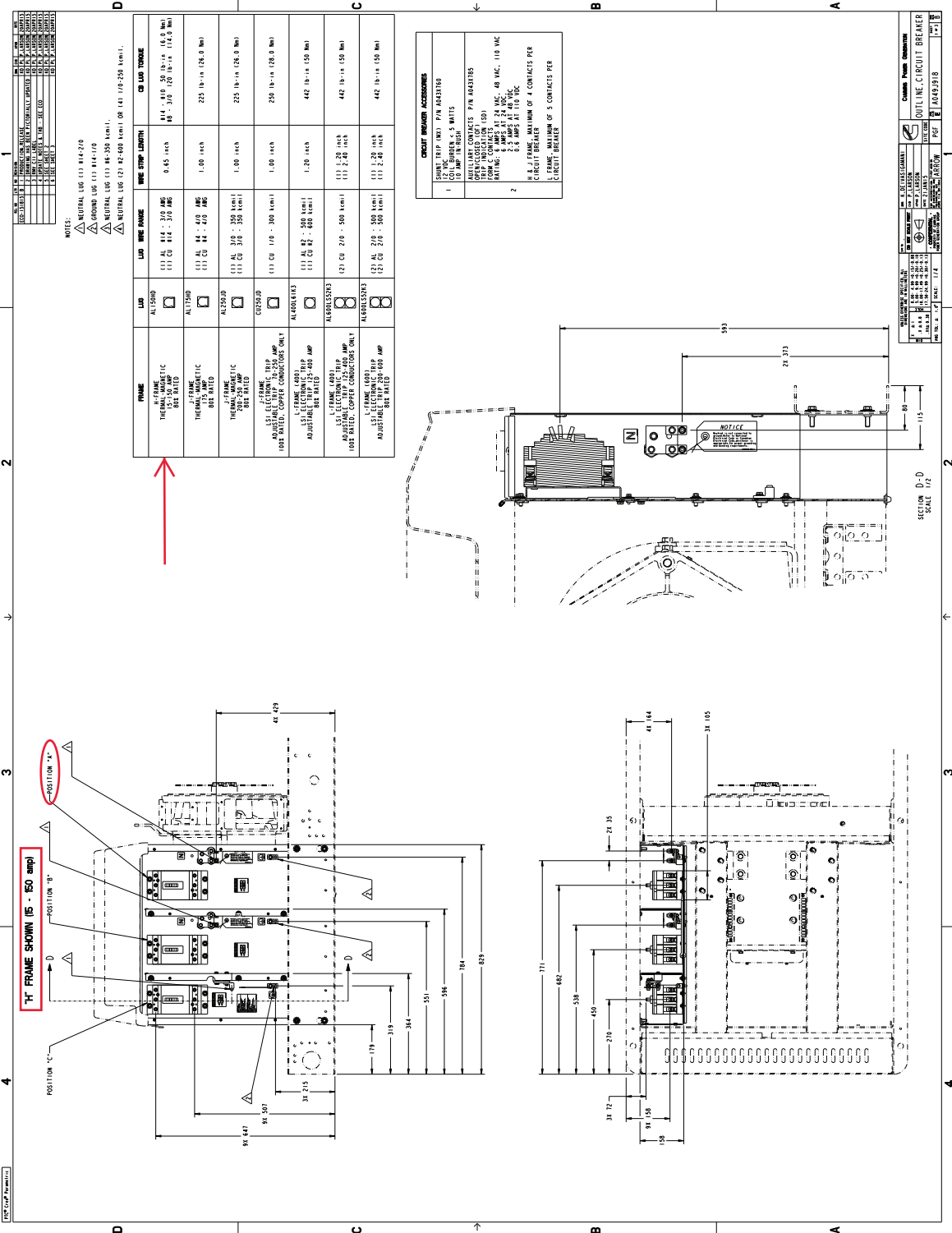

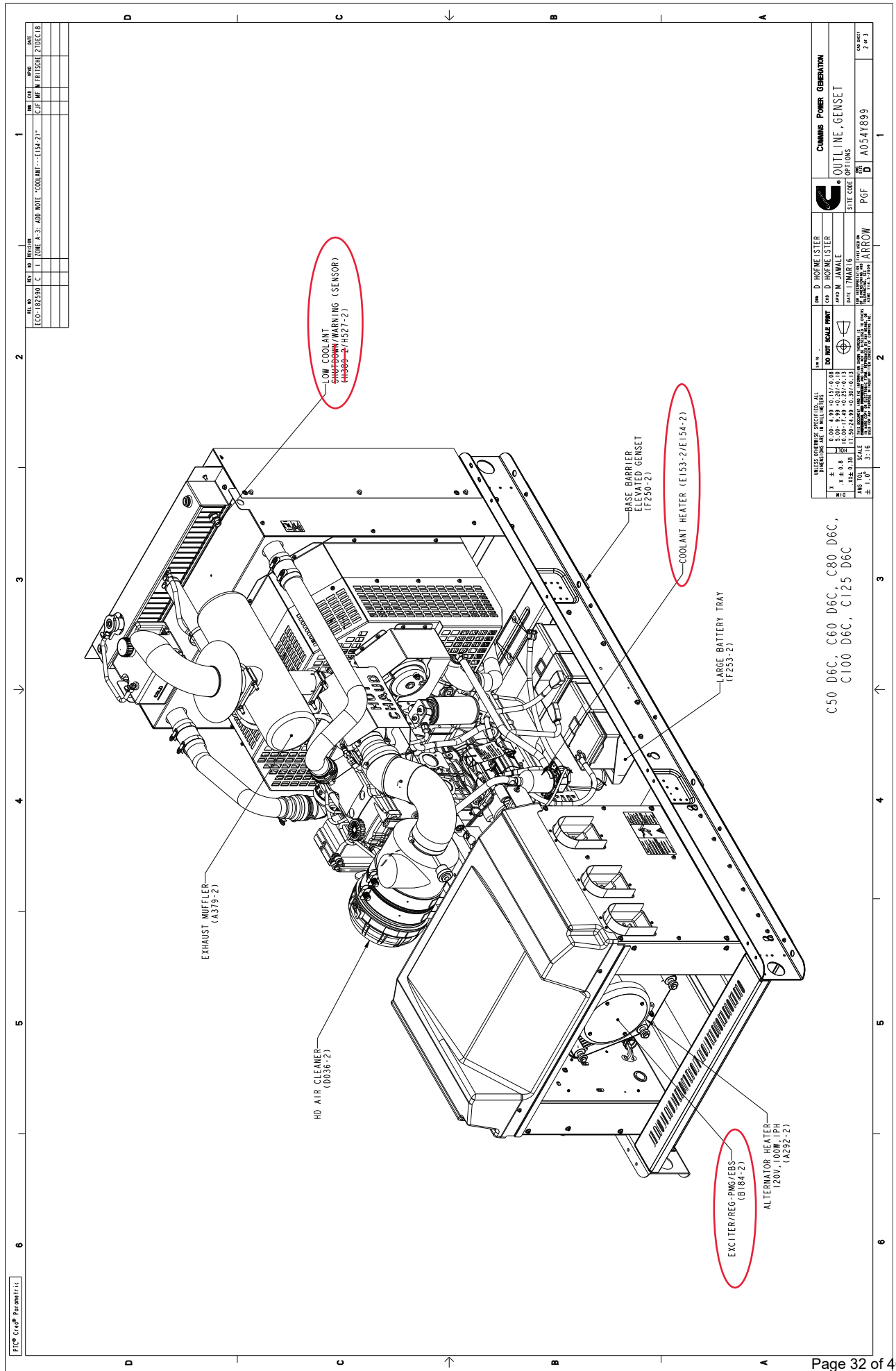

LOW COOLANT
SHUT-DOWN/WARNING (SENSOR)
H300-2/H527-2

COOLANT HEATER (E153-2/E154-2)

LARGE BATTERY TRAY
(F253-2)

EXCITER/REG-PNG/EBS
(B184-2)

ALTERNATOR HEATER
120V, 100W, 1PH
(A292-2)

EXHAUST MUFFLER
(A319-2)

HD AIR CLEANER
(D036-2)

BASE BARRIER
ELEVATED GENSET
(F230-2)

C50 D6C, C60 D6C, C80 D6C,
C100 D6C, C125 D6C

REV. NO.	REV. DATE	REV. BY	REV. DESCRIPTION
ECO-182590	C 11 11/04 P.3	A054Y900	ECO-182590-1 (E154-2)
		CPT	ECO-182590-2 (E154-2)

		CUMMINS POWER GENERATION	
ECO UNIT SCALE POINT		ECO OUTLINE GENSET	
DRAWING NO. ECO-182590 TITLE C 11 11/04 P.3		DRAWING NO. A054Y900 TITLE C 11 11/04 P.3	
DESIGNED BY: [Blank] CHECKED BY: [Blank]		DESIGNED BY: [Blank] CHECKED BY: [Blank]	
DATE: 11/11/04		DATE: 11/11/04	
SCALE: 1:1		SCALE: 1:1	
SHEET NO. 2 OF 3		SHEET NO. 2 OF 3	



Sound data

C100D6C

QSB5-G13 60Hz

Diesel Generator Set

Sound Pressure Level @ 7 meters, dB(A)

See notes 2,5,7-11 listed below

Configuration	Exhaust system	Position (Note 1)								8 Position Average
		1	2	3	4	5	6	7	8	
Standard – Unhoused	Infinite Exhaust	78	80.3	80.6	82.3	78.7	81.7	81.7	80.6	80.7
F216-2 Weather Protective Aluminium	Mounted	80.1	82.1	80.3	82.9	81.1	82.4	81.2	81.5	81.5
F231-2 Sound Attenuated Level 1, Aluminium	Mounted	78.8	75.6	71.6	72.8	72.5	73.2	72.5	75.5	74.7
F217-2 Sound Attenuated Level 2, Aluminium	Mounted	72.6	72.9	69.7	71	70.9	71.2	71.7	71.8	71.6

Sound Power Level, dB(A)

See notes 2-4, 7 and 8 listed below

Configuration		Octave Band Center Frequency (Hz)										Overall Sound Power Level
		31.5	63	125	250	500	1000	2000	4000	8000	16000	
Standard – Unhoused	Infinite Exhaust	54.3	79.2	89.0	92.1	100.7	102.3	101.8	98.2	94.8	90.6	107.6
F216-2 Weather Protective Aluminium	Mounted	56.1	89.2	99.2	99.8	102.8	103.7	101.7	99.7	95.3	85.8	109.5
F231-2 Sound Attenuated Level 1, Aluminium	Mounted	58.2	86.0	88.8	91.2	95.5	97.5	95.5	92.7	89.4	82.1	102.6
F217-2 Sound Attenuated Level 2, Aluminium	Mounted	57.4	86.1	88.0	89.7	93.1	92.9	90.4	87.8	84.2	74.8	99.0

Exhaust Sound Power Level, dB(A)

See notes 4,6 and 9 listed below

Open Exhaust (No Muffler) @ Rated Load	Octave Band Center Frequency (Hz)									Overall Sound Power Level
	31.5	63	125	250	500	1000	2000	4000	8000	
	57	84	99	105	112	113	116	116	113	122

Note:

1. Sound pressure levels at 1 meter are measured per the requirements of ISO 3744, ISO 8528-10, ANSI S1.13, ANSI S12.1 and European Communities Directive 2000/14/EC as applicable. The microphone measurement locations are 1 meter from a reference parallelepiped just enclosing the generator set (enclosed or unenclosed).
2. Seven-meter measurement location 1 is 7 meters (23 feet) from the generator (alternator) end of the generator set, and the locations proceed counter clockwise around the generator set at 45° angles at a height of 1.2 meters (48 inches) above the ground surface.
3. Sound Power Levels are calculated according to ISO 3744, ISO 8528-10, and or CE (European Union) requirements.
4. Exhaust Sound Levels are measured and calculated per ISO 6798, Annex A.
5. Reference Sound Pressure Level is 20 µPa.
6. Reference Sound Power Level is 1 pW (10-12 Watt).
7. Sound data for remote-cooled generator sets are based on rated loads without cooling fan noise.
8. Sound data for the generator set with infinite exhaust do not include the exhaust noise contribution.
9. Sound levels are subject to instrumentation, measurement, installation, and manufacturing variability



Sound data

C100D6C

QSB5-G13 60Hz

Diesel Generator Set

10. Unhoused/Open configuration generator sets refers to generator sets with no sound enclosures of any kind
11. Housed/Enclosed/Closed/Canopy configuration generator sets refer to generator sets that have noise reduction sound enclosures installed over the generator set and usually integrally attached to the skid base/base frame/fuel container base of the generator set.



Dual wall sub-base diesel fuel tanks - 10-200 kW generator sets



Description

Cummins® offers two series of fuel tanks (basic series and regional series) for the 10~125 kW diesel generator sets. The “basic” series of fuel tanks provide economical solutions for areas with no or minimal local/regional code requirements on diesel fuel tanks. The footprint of “basic” tanks matches the generator set’s footprint. The “regional” series of fuel tanks provide flexible and upgradable solutions for areas with extensive local/regional code requirements on diesel fuel tanks. The footprint of the “regional” series of fuel tanks extends beyond the generator set to allow room for installation of optional features at factory or accessories in the field for meeting local/regional code requirements or customer specification on diesel fuel tanks. All fuel tanks and optional features are compatible with factory installed enclosures.

These tanks are constructed of heavy gauge steel and include an internally reinforced baffle structure for supporting the generator set. The fuel tank design features fewer seams and welds for better corrosion resistance performance.

These tanks are pre-treated with a conversion coating and then finished with a textured powder paint. The paint has superior UV and chemical resistance with best-in-class adhesion, flexibility, and durability to resist chipping and substrate corrosion. Both interior compartments are treated with a rust preventative for extended corrosion protection.

These tanks are UL and ULC Listed as secondary containment generator base tanks. Inner and outer containments are leak checked per UL and ULC testing procedures to ensure their integrity.

These fuel tanks are offered in various sizes to satisfy different fuel capacities requirements.

Compatible generator set model

Engine	D1703M	V2203M	4BT3.3-G5	4BTAA3.3-G7	QSB5-G5	QSB7-G5
Generator set model names	C10D6	C20D6	C25D6	C50D6	C50D6C	C125D6D
	C15D6		C30D6	C60D6	C60D6C	C150D6D
			C35D6		C80D6C	C175D6D
			C40D6		C100D6C	C200D6D
					C125D6C	

Basic fuel tanks

Standard features:

UL 142 and ULC-S601 listed - Minimum 110% secondary containment capacity.

NFPA and IFC - Capable of meeting NFPA 30 and NFPA 110 codes with available factory installed optional features.

Emergency pressure relief vents - Ensure adequate ventilation of the primary and secondary tank compartments under extreme temperature and emergency conditions.

Normal atmospheric vent - "Mushroom" style vent ensures adequate venting of the primary tank during fill, generator set running and temperature variations. Raised above fuel fill.

Raised fuel fill - includes lockable sealed fuel cap.

Lifting eyes - Allow lifting of fuel tank with generator set installed.

Optional features:

Secondary containment basin switch (rupture switch) - Activates a warning in the event of a primary tank leak. Side mounted.

Low fuel level switch - Activates a warning when 40% of the fuel is left in the tank.

Fuel level gauge - Provides direct reading of fuel level. Top mounted.

Electric fuel level sender with gauge - Allows remote electrical monitoring of fuel tank level. Flying leads for customer connection.

Tank to foundation clearance - 2-inch bolt-thru risers allow visual inspection under tank including rodent barrier.

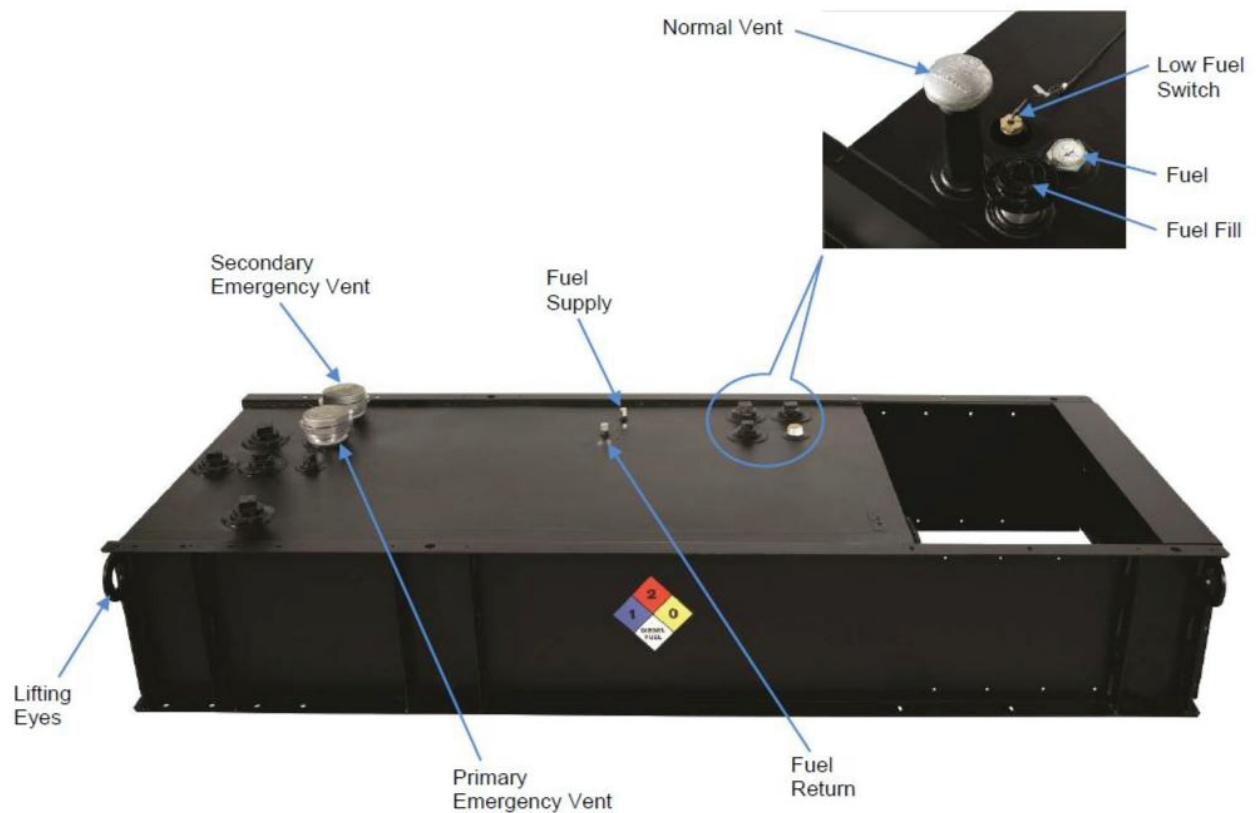

*Picture is for reference only. See outline drawing for tank specific information by model.

Basic tanks

Generator set Standby power output	Generator set model	Engine model	Fuel consumption (100% load, Standby)	Tank feature code	Minimum run time feature	Tank dimensions (L x W x H)	Nominal dry weight*	Tank usable volume	Actual run time
kW			gal/hr		hr	inch	lbs	gal	hr
10	C10D6	D1703M	1.12	C319-2	24	65.7 x 34 x 13	310	46	41
				C320-2	48	65.7 x 34 x 23	583	91	81
15	C15D6	D1703M	1.38	C319-2	24	65.7 x 34 x 13	310	46	33
				C320-2	48	65.7 x 34 x 23	583	91	66
20	C20D6	V2203M	1.81	C319-2	24	65.7 x 34 x 13	310	46	25
				C320-2	48	65.7 x 34 x 23	583	91	50
25	C25D6	4BT3.3-G5	2.42	C319-2	24	87.6 x 34 x 15	456	74	31
				C320-2	48	87.6 x 34 x 23	669	132	54
30	C30D6	4BT3.3-G5	2.81	C319-2	24	87.6 x 34 x 15	456	74	26
				C320-2	48	87.6 x 34 x 32	908	195	69
35	C35D6	4BT3.3-G5	3.16	C319-2	24	87.6 x 34 x 23	669	132	42
				C320-2	48	87.6 x 34 x 32	908	195	62
40	C40D6	4BT3.3-G5	3.66	C319-2	24	87.6 x 34 x 23	669	132	36
				C320-2	48	87.6 x 34 x 32	908	195	53
50	C50D6	4BTAA3.3-G7	4.25	C319-2	24	87.6 x 34 x 23	669	132	31
				C320-2	48	87.6 x 34 x 42	977	263	62
60	C60D6	4BTAA3.3-G7	5.04	C319-2	24	87.6 x 34 x 23	669	132	26
				C320-2	48	87.6 x 34 x 42	977	263	52
50	C50D6C	QSB5-G5	5.30	C319-2	24	117 x 40 x 25	809	260	49
				C320-2	48	117 x 40 x 25	809	260	49
60	C60D6C	QSB5-G5	6.10	C319-2	24	117 x 40 x 25	809	260	42
				C320-2	48	117 x 40 x 33	966	353	57
80	C80D6C	QSB5-G5	7.30	C319-2	24	117 x 40 x 25	809	260	35
				C320-2	48	117 x 40 x 33	966	353	48
100	C100D6C	QSB5-G5	8.90	C319-2	24	117 x 40 x 25	809	260	29
				C320-2	48	117 x 40 x 48	1471	526	59
125	C125D6C	QSB5-G6	10.30	C319-2	24	117 x 40 x 25	809	260	25
				C320-2	48	117 x 40 x 48	1471	526	51
125	C125D6D	QSB7-G5	10.1	C319-2	24	117x40x25	809	258	25
				C320-2	48	117x40x48	1471	520	51
150	C150D6D		11.7	C319-2	24	117x40x33	966	350	29
				C320-2	48	180x40x42	2302	737	62
175	C175D6D		13.3	C319-2	24	117x40x33	966	350	26
				C320-2	48	180x40x42	2302	737	55
200	C200D6D	14.9	C319-2	24	117x40x48	1471	520	34	
			C320-2	48	180x40x42	2302	737	49	

Note: No OFPV is offered on basic fuel tanks.

* All weights are approximate.

see below drawings for overall shipping weight and dimensions

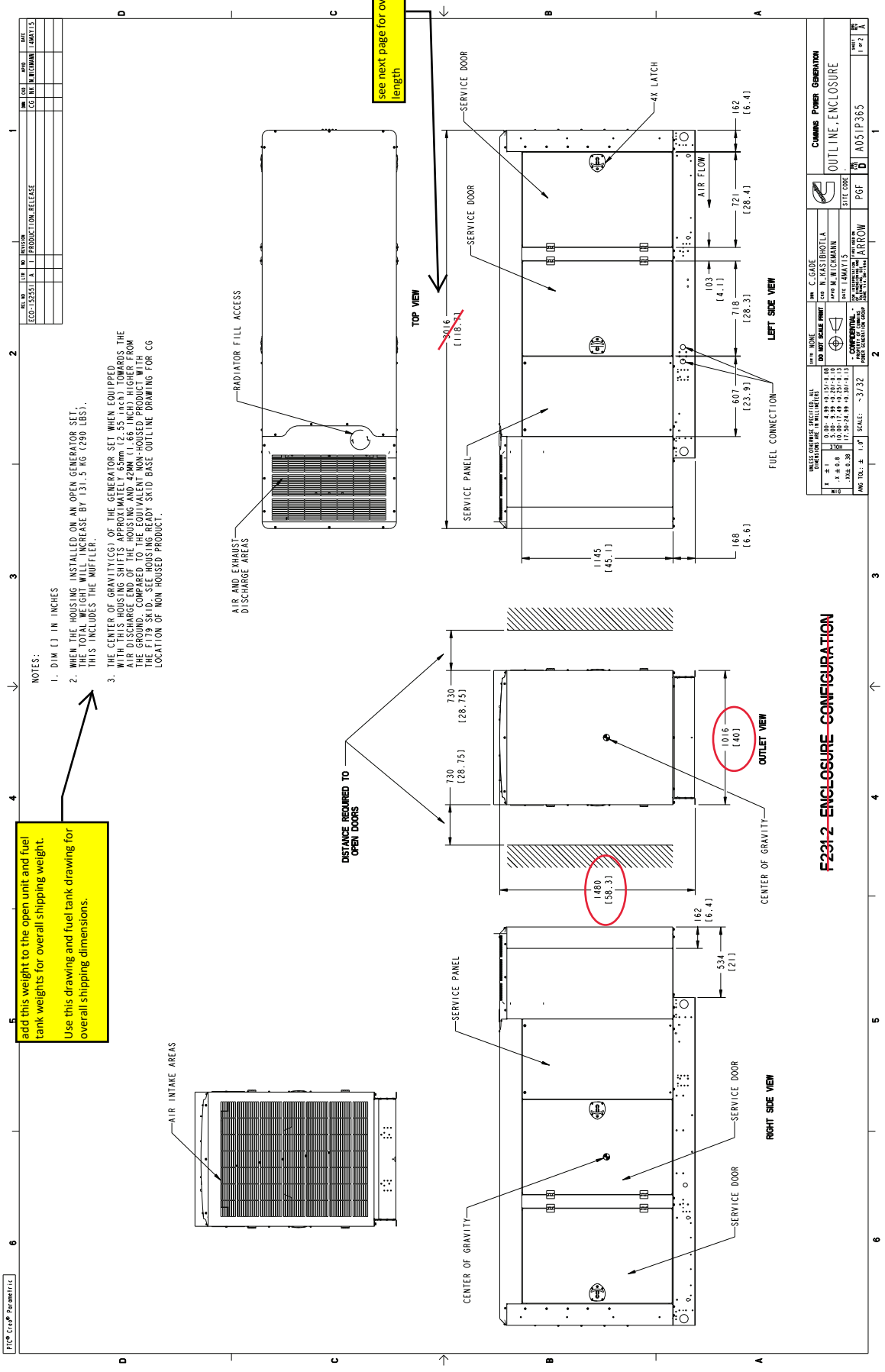

add this weight to the open unit and fuel tank weights for overall shipping weight. Use this drawing and fuel tank drawing for overall shipping dimensions.

- NOTES:
1. DIM 1 IN INCHES
 2. WHEN THE HOUSING IS INSTALLED ON AN OPEN GENERATOR SET, THE TOTAL WEIGHT WILL INCREASE BY 131.5 KG (290 LBS). THIS INCLUDES THE MUFFLER.
 3. THE GENERATOR SET WHEN EQUIPPED WITH THIS HOUSING SHIFTS APPROXIMATELY 65mm (2.55 INCH) TOWARDS THE AIR DISCHARGE END OF THE HOUSING AND 42MM (1.66 INCH) HIGHER FROM THE GROUND. COMPARE THE EQUIVALENT NON-HOUSED PRODUCT WITH THE GROUNDING SCHEMATIC OF THE EQUIVALENT PRODUCT TO DETERMINE THE LOCATION OF NON-HOUSED PRODUCT.

F231-2 ENCLOSURE CONFIGURATION

DIM C, GAUGE DIM D, GAUGE DIM E, GAUGE DIM F, GAUGE DIM G, GAUGE DIM H, GAUGE DIM I, GAUGE DIM J, GAUGE DIM K, GAUGE DIM L, GAUGE DIM M, GAUGE DIM N, GAUGE DIM O, GAUGE DIM P, GAUGE DIM Q, GAUGE DIM R, GAUGE DIM S, GAUGE DIM T, GAUGE DIM U, GAUGE DIM V, GAUGE DIM W, GAUGE DIM X, GAUGE DIM Y, GAUGE DIM Z, GAUGE		DIM 1, GAUGE DIM 2, GAUGE DIM 3, GAUGE DIM 4, GAUGE DIM 5, GAUGE DIM 6, GAUGE DIM 7, GAUGE DIM 8, GAUGE DIM 9, GAUGE DIM 10, GAUGE DIM 11, GAUGE DIM 12, GAUGE DIM 13, GAUGE DIM 14, GAUGE DIM 15, GAUGE DIM 16, GAUGE DIM 17, GAUGE DIM 18, GAUGE DIM 19, GAUGE DIM 20, GAUGE DIM 21, GAUGE DIM 22, GAUGE DIM 23, GAUGE DIM 24, GAUGE DIM 25, GAUGE DIM 26, GAUGE DIM 27, GAUGE DIM 28, GAUGE DIM 29, GAUGE DIM 30, GAUGE DIM 31, GAUGE DIM 32, GAUGE DIM 33, GAUGE DIM 34, GAUGE DIM 35, GAUGE DIM 36, GAUGE DIM 37, GAUGE DIM 38, GAUGE DIM 39, GAUGE DIM 40, GAUGE DIM 41, GAUGE DIM 42, GAUGE DIM 43, GAUGE DIM 44, GAUGE DIM 45, GAUGE DIM 46, GAUGE DIM 47, GAUGE DIM 48, GAUGE DIM 49, GAUGE DIM 50, GAUGE DIM 51, GAUGE DIM 52, GAUGE DIM 53, GAUGE DIM 54, GAUGE DIM 55, GAUGE DIM 56, GAUGE DIM 57, GAUGE DIM 58, GAUGE DIM 59, GAUGE DIM 60, GAUGE DIM 61, GAUGE DIM 62, GAUGE DIM 63, GAUGE DIM 64, GAUGE DIM 65, GAUGE DIM 66, GAUGE DIM 67, GAUGE DIM 68, GAUGE DIM 69, GAUGE DIM 70, GAUGE DIM 71, GAUGE DIM 72, GAUGE DIM 73, GAUGE DIM 74, GAUGE DIM 75, GAUGE DIM 76, GAUGE DIM 77, GAUGE DIM 78, GAUGE DIM 79, GAUGE DIM 80, GAUGE DIM 81, GAUGE DIM 82, GAUGE DIM 83, GAUGE DIM 84, GAUGE DIM 85, GAUGE DIM 86, GAUGE DIM 87, GAUGE DIM 88, GAUGE DIM 89, GAUGE DIM 90, GAUGE DIM 91, GAUGE DIM 92, GAUGE DIM 93, GAUGE DIM 94, GAUGE DIM 95, GAUGE DIM 96, GAUGE DIM 97, GAUGE DIM 98, GAUGE DIM 99, GAUGE DIM 100, GAUGE	
DIM 101, GAUGE DIM 102, GAUGE DIM 103, GAUGE DIM 104, GAUGE DIM 105, GAUGE DIM 106, GAUGE DIM 107, GAUGE DIM 108, GAUGE DIM 109, GAUGE DIM 110, GAUGE DIM 111, GAUGE DIM 112, GAUGE DIM 113, GAUGE DIM 114, GAUGE DIM 115, GAUGE DIM 116, GAUGE DIM 117, GAUGE DIM 118, GAUGE DIM 119, GAUGE DIM 120, GAUGE DIM 121, GAUGE DIM 122, GAUGE DIM 123, GAUGE DIM 124, GAUGE DIM 125, GAUGE DIM 126, GAUGE DIM 127, GAUGE DIM 128, GAUGE DIM 129, GAUGE DIM 130, GAUGE DIM 131, GAUGE DIM 132, GAUGE DIM 133, GAUGE DIM 134, GAUGE DIM 135, GAUGE DIM 136, GAUGE DIM 137, GAUGE DIM 138, GAUGE DIM 139, GAUGE DIM 140, GAUGE DIM 141, GAUGE DIM 142, GAUGE DIM 143, GAUGE DIM 144, GAUGE DIM 145, GAUGE DIM 146, GAUGE DIM 147, GAUGE DIM 148, GAUGE DIM 149, GAUGE DIM 150, GAUGE DIM 151, GAUGE DIM 152, GAUGE DIM 153, GAUGE DIM 154, GAUGE DIM 155, GAUGE DIM 156, GAUGE DIM 157, GAUGE DIM 158, GAUGE DIM 159, GAUGE DIM 160, GAUGE DIM 161, GAUGE DIM 162, GAUGE DIM 163, GAUGE DIM 164, GAUGE DIM 165, GAUGE DIM 166, GAUGE DIM 167, GAUGE DIM 168, GAUGE DIM 169, GAUGE DIM 170, GAUGE DIM 171, GAUGE DIM 172, GAUGE DIM 173, GAUGE DIM 174, GAUGE DIM 175, GAUGE DIM 176, GAUGE DIM 177, GAUGE DIM 178, GAUGE DIM 179, GAUGE DIM 180, GAUGE DIM 181, GAUGE DIM 182, GAUGE DIM 183, GAUGE DIM 184, GAUGE DIM 185, GAUGE DIM 186, GAUGE DIM 187, GAUGE DIM 188, GAUGE DIM 189, GAUGE DIM 190, GAUGE DIM 191, GAUGE DIM 192, GAUGE DIM 193, GAUGE DIM 194, GAUGE DIM 195, GAUGE DIM 196, GAUGE DIM 197, GAUGE DIM 198, GAUGE DIM 199, GAUGE DIM 200, GAUGE		DIM 201, GAUGE DIM 202, GAUGE DIM 203, GAUGE DIM 204, GAUGE DIM 205, GAUGE DIM 206, GAUGE DIM 207, GAUGE DIM 208, GAUGE DIM 209, GAUGE DIM 210, GAUGE DIM 211, GAUGE DIM 212, GAUGE DIM 213, GAUGE DIM 214, GAUGE DIM 215, GAUGE DIM 216, GAUGE DIM 217, GAUGE DIM 218, GAUGE DIM 219, GAUGE DIM 220, GAUGE DIM 221, GAUGE DIM 222, GAUGE DIM 223, GAUGE DIM 224, GAUGE DIM 225, GAUGE DIM 226, GAUGE DIM 227, GAUGE DIM 228, GAUGE DIM 229, GAUGE DIM 230, GAUGE DIM 231, GAUGE DIM 232, GAUGE DIM 233, GAUGE DIM 234, GAUGE DIM 235, GAUGE DIM 236, GAUGE DIM 237, GAUGE DIM 238, GAUGE DIM 239, GAUGE DIM 240, GAUGE DIM 241, GAUGE DIM 242, GAUGE DIM 243, GAUGE DIM 244, GAUGE DIM 245, GAUGE DIM 246, GAUGE DIM 247, GAUGE DIM 248, GAUGE DIM 249, GAUGE DIM 250, GAUGE DIM 251, GAUGE DIM 252, GAUGE DIM 253, GAUGE DIM 254, GAUGE DIM 255, GAUGE DIM 256, GAUGE DIM 257, GAUGE DIM 258, GAUGE DIM 259, GAUGE DIM 260, GAUGE DIM 261, GAUGE DIM 262, GAUGE DIM 263, GAUGE DIM 264, GAUGE DIM 265, GAUGE DIM 266, GAUGE DIM 267, GAUGE DIM 268, GAUGE DIM 269, GAUGE DIM 270, GAUGE DIM 271, GAUGE DIM 272, GAUGE DIM 273, GAUGE DIM 274, GAUGE DIM 275, GAUGE DIM 276, GAUGE DIM 277, GAUGE DIM 278, GAUGE DIM 279, GAUGE DIM 280, GAUGE DIM 281, GAUGE DIM 282, GAUGE DIM 283, GAUGE DIM 284, GAUGE DIM 285, GAUGE DIM 286, GAUGE DIM 287, GAUGE DIM 288, GAUGE DIM 289, GAUGE DIM 290, GAUGE DIM 291, GAUGE DIM 292, GAUGE DIM 293, GAUGE DIM 294, GAUGE DIM 295, GAUGE DIM 296, GAUGE DIM 297, GAUGE DIM 298, GAUGE DIM 299, GAUGE DIM 300, GAUGE	

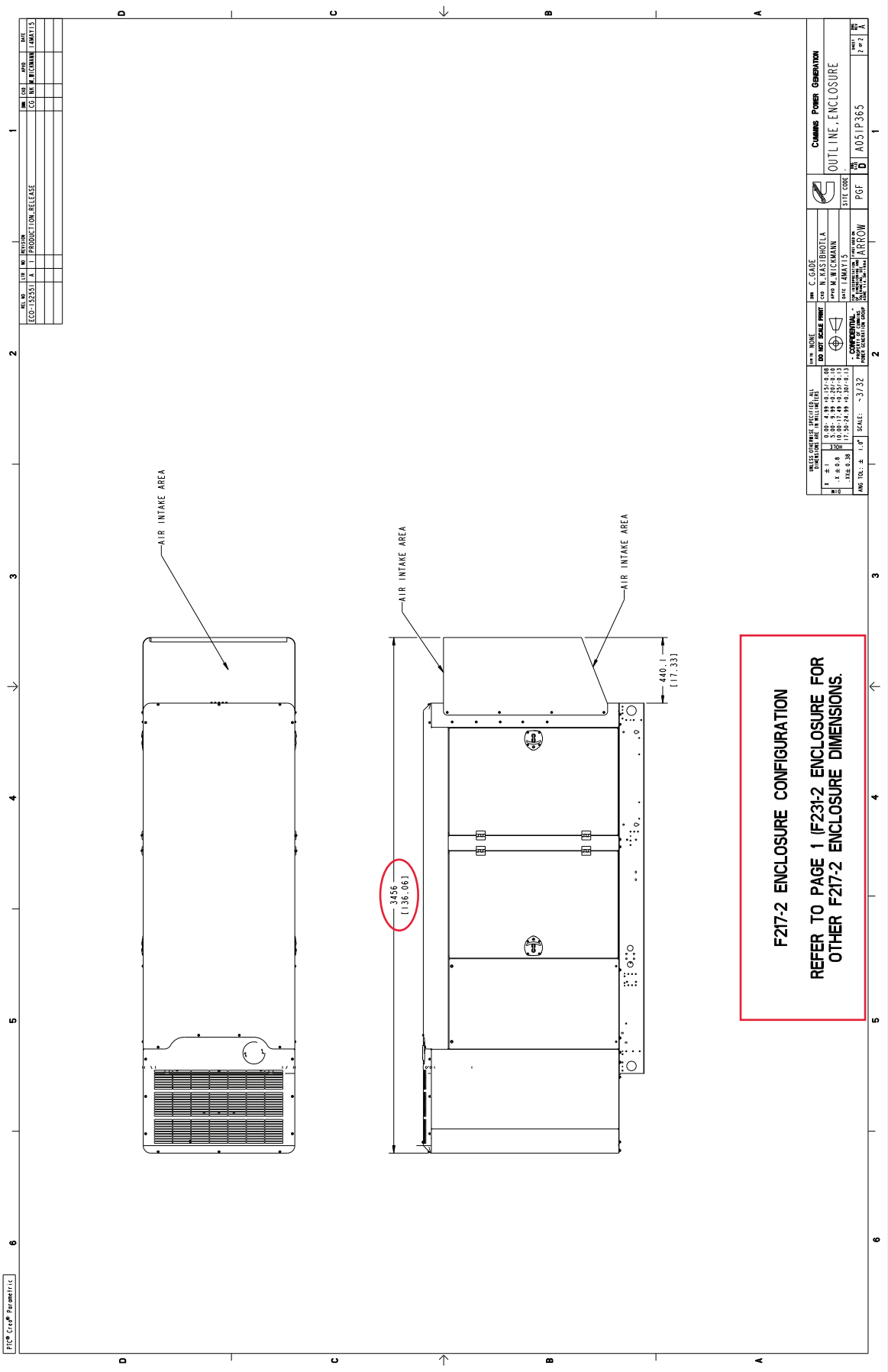

**F217-2 ENCLOSURE CONFIGURATION
REFER TO PAGE 1 (F231-2 ENCLOSURE FOR
OTHER F217-2 ENCLOSURE DIMENSIONS.)**

TITLE BLOCK ECO-155551 A - 1 PRODUCTION RELEASE REV. NO. DATE BY LOG # INFORMATION COMMENTS		PROJECT CODE PGF B A051P365	
MANUFACTURER CUMMINS POWER GENERATION		PART NAME OUTLINE, ENCLOSURE	
DRAWING NUMBER ECO-155551 A - 1		SCALE 1:1	
SHEET NUMBER 1 OF 3		DATE 11/19/19	

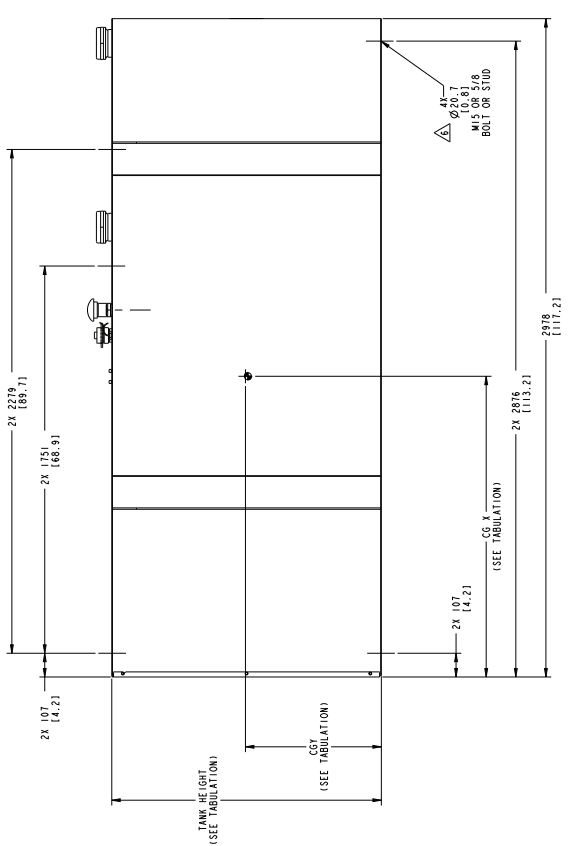
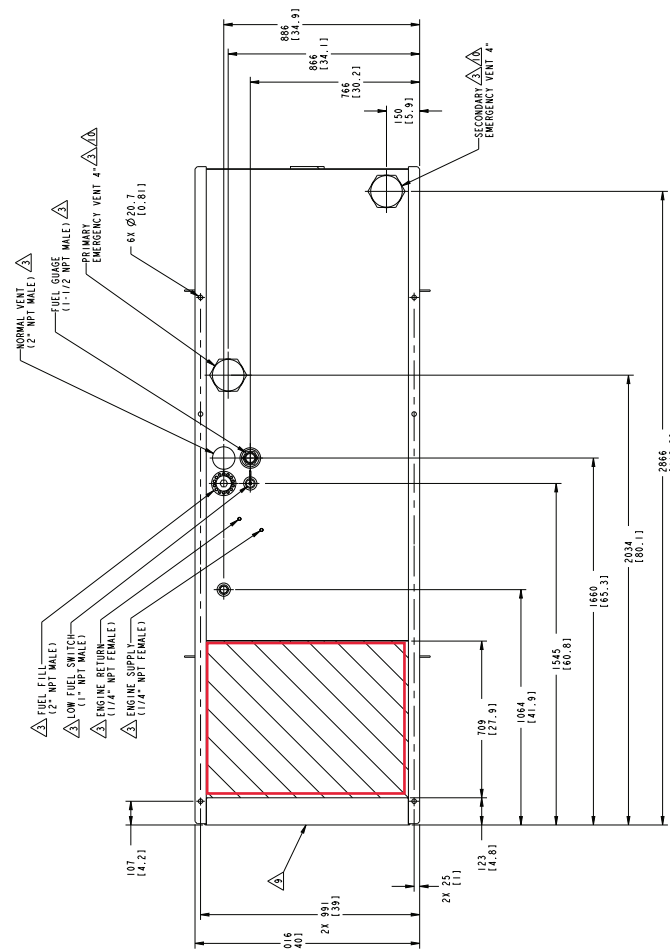

add this weight to the open unit and enclosure weights for overall shipping weight.
Use this drawing and enclosure drawing for overall shipping dimensions.

PART NUMBER			INSTALLATION		
GENSET MODEL	TANK FEATURE	CODE	BULK TIME	MIN	MAX
C319-2			C320-2		
APPLICATION	24 HR		48 HR		
C50 DEC	A053H409		A053H409		
C60 DEC	A053H409		A053H411		
C70 DEC	A053H409		A053H412		
C725 DEC	A053H409		A053H412		

TANK NUMBER	TANK HEIGHT	TANK VOLUME - (LITERS / GALS)		WEIGHT - (KG / LBS)		CG Y	
		TOTAL	USABLE	MIN	MAX	MIN	MAX
A053H409	635 (25)	985 (260)	978 (258)	367 (809)	1736 (381)	1832 (403)	299 (11.8)
A053H411	838 (33)	1338 (353)	1327 (350)	439 (966)	1567 (345)	1736 (381)	398 (15.7)
A053H412	1219 (48)	1944 (516)	1931 (520)	668 (147)	2344 (516)	2396 (528)	584 (23.0)

ECO-17494A C 1 ECO-17494A C 1 2 3 4		DATE: 01/11/2018 TIME: 11:23:43 AM USER: JAVILE	PROJECT: ARROW PGF: A054T898
CUSTOMER: OUTLINE, TANK		DATE CODE: MISC	

- NOTES:**
- TANKS ARE UL102 LISTER, SECONDARY CONTAINMENT FUEL TANK. REFER TO TANK LABELS AND LOCAL CODE COMPARTMENTS.
 - SUBBASE FUEL TANK MOUNTING: FUEL TANK MAY RESULT IN STRUCTURAL FAILURE OF THE TANK. TO ENSURE THE INSTALLATION DOES NOT EXCESSIVELY TWIST BE OBSERVED:
 - REFER TO APPLICATION MANUAL T030 FOR GENERAL SET MOUNTING GUIDELINES.
 - AFTER PLACING SET ON FOUNDATION, VERIFY ALL FOUR MOUNTING PADS CONTACT FOUNDATION.
 - THERE ARE SHIMS ATTACHED TO EACH FUEL TANK THESE ARE INTENDED TO FILL ANY GAP BETWEEN THE MOUNTING PADS AND FOUNDATION.
 - INSERT THE MAXIMUM HEIGHT STACK OF SHIMS THAT WILL SLIDE INTO THE GAP.
 - TIGHTEN TANK HOLD DOWN MOUNTING FASTENERS.
 - INDICATES PIPE SIZE OF FEATURE OR OPTION INDICATED.
 - DIMENSIONS IN () ARE IN INCHES.
 - FOR IBC SEISMIC CERTIFIED INSTALLATIONS, SEE GENSET IBC SEISMIC INSTALLATION REQUIREMENTS DRAWING.
 - FUEL TANK HAS A FLANGE THICKNESS OF UP TO 48 mm (1.9") FOR ALL LENGTHS AND LENGTH ON HARDWARE FOR THE PURPOSE OF MOUNTING SURFACE.
 - REFER TO IBC SEISMIC CERTIFICATION FOR MORE INFORMATION. SEE APPLICATION MANUAL (SEE SHEET 31).
 - INSTALLATION & REMOVAL LIFTING AND SERVICE ACCESS CLEARANCE (SUGGESTED MINIMUM) - (SEE SHEET 31).
 - REMOVABLE STUB-UP ACCESS PANEL.
 - MAINTAIN MIN 51 mm (2") CLEARANCE ABOVE E-VENT.
 - WEIGHT AND CENTER OF GRAVITY INFORMATION IS ESTIMATED AND CHANGES WITH TANK FEATURE INSTALLATION.

REV.	DATE	BY	DESCRIPTION
1			ECO-174944 C

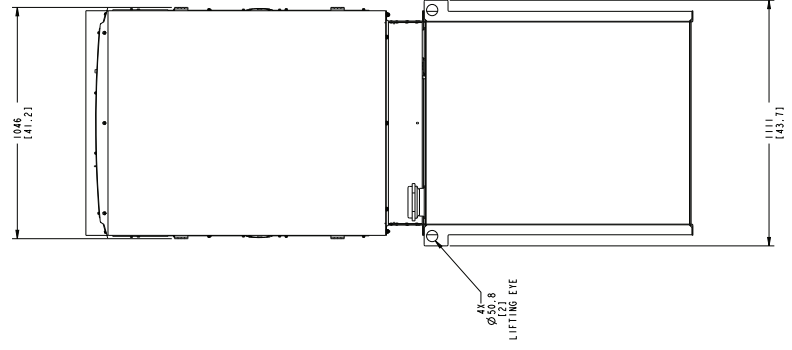
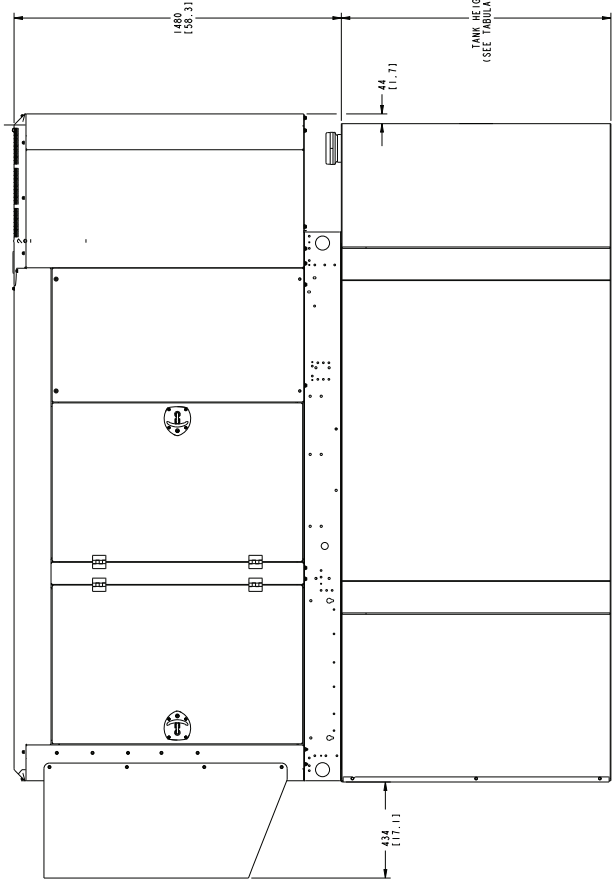
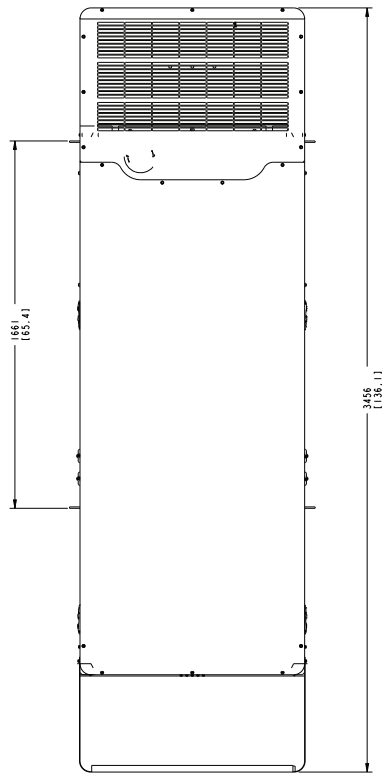

D

C

B

A

D

C

B

DESIGNED BY	DATE	BY	DESCRIPTION
1			ECO-174944 C

PROJECT	ECO-174944
DATE	11/15/11
SCALE	AS SHOWN
PROJECT	ECO-174944
DATE	11/15/11
SCALE	AS SHOWN

DESIGNED BY	DATE	BY	DESCRIPTION
1			ECO-174944 C

PROJECT	ECO-174944
DATE	11/15/11
SCALE	AS SHOWN
PROJECT	ECO-174944
DATE	11/15/11
SCALE	AS SHOWN

PROJECT	ECO-174944
DATE	11/15/11
SCALE	AS SHOWN
PROJECT	ECO-174944
DATE	11/15/11
SCALE	AS SHOWN

PROJECT	ECO-174944
DATE	11/15/11
SCALE	AS SHOWN
PROJECT	ECO-174944
DATE	11/15/11
SCALE	AS SHOWN

PROJECT	ECO-174944
DATE	11/15/11
SCALE	AS SHOWN
PROJECT	ECO-174944
DATE	11/15/11
SCALE	AS SHOWN

PROJECT	ECO-174944
DATE	11/15/11
SCALE	AS SHOWN
PROJECT	ECO-174944
DATE	11/15/11
SCALE	AS SHOWN

PROJECT	ECO-174944
DATE	11/15/11
SCALE	AS SHOWN
PROJECT	ECO-174944
DATE	11/15/11
SCALE	AS SHOWN

PROJECT	ECO-174944
DATE	11/15/11
SCALE	AS SHOWN
PROJECT	ECO-174944
DATE	11/15/11
SCALE	AS SHOWN

PROJECT	ECO-174944
DATE	11/15/11
SCALE	AS SHOWN
PROJECT	ECO-174944
DATE	11/15/11
SCALE	AS SHOWN

PROJECT	ECO-174944
DATE	11/15/11
SCALE	AS SHOWN
PROJECT	ECO-174944
DATE	11/15/11
SCALE	AS SHOWN

PROJECT	ECO-174944
DATE	11/15/11
SCALE	AS SHOWN
PROJECT	ECO-174944
DATE	11/15/11
SCALE	AS SHOWN

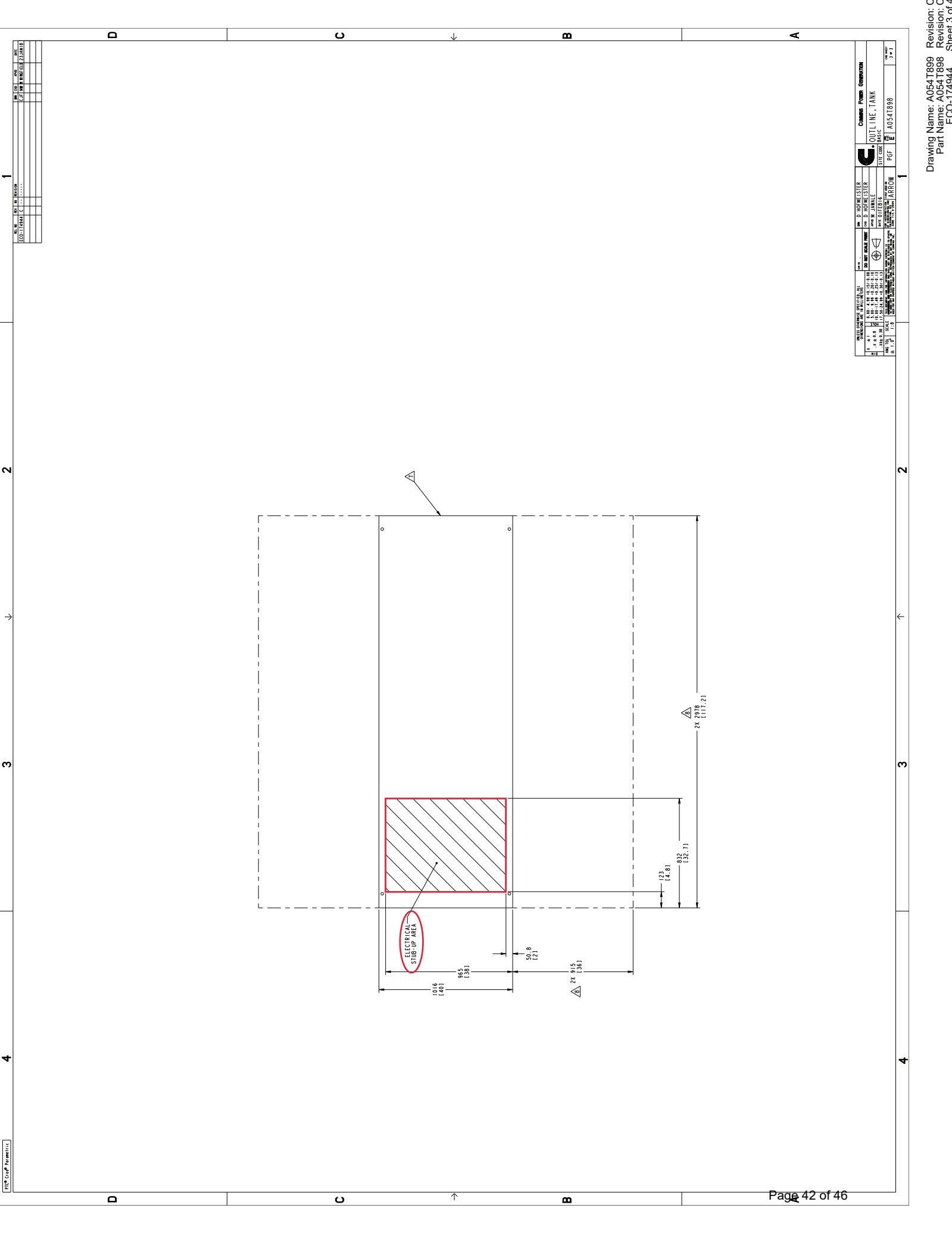

REV.	DATE	BY	CHKD.	DESCRIPTION
1	02/17/2014	C		ISSUE FOR PERMITS/ISSUE 23/24/14

DATE	BY	CHKD.	DESCRIPTION
02/17/2014	C		ISSUE FOR PERMITS/ISSUE 23/24/14

PROJECT NO.	115
DATE	02/17/2014
SCALE	AS SHOWN
PROJECT	OUTLINE - TANK
SITE CODE	MA5C
PG#	1
PROJECT	A054T898

Drawing Name: A054T899
 Revision: C
 Part Name: A054T898
 ECO-174944
 Sheet 3 of 4



Battery charger-6 amp

A045D925 60Hz/50Hz



Description

Cummins Power Generation fully automatic battery chargers are designed to both recharge your batteries, and extend your battery's life in applications where it is stored for long periods of time. This charger can handle poor power quality, exposure to extreme weather and rough handling.

To maximize battery life, a 3-stage charging cycle is implemented. The three charging stages are bulk stage, absorption stage and maintenance stage. During the bulk stage, the charger uses its full amp output to do the heaviest charging, quickly bringing your battery to about 75% of capacity. In the absorption stage, the current slows, adjusting for maximum charging efficiency while it gently tops off the battery to about 98% of capacity.

During the maintenance stage, a lower, closely-regulated, constant voltage is applied to maintain full charge and prevent discharge.

Unlike some "trickle chargers," the float charger won't apply more current than necessary to maintain full charge. Batteries can be connected indefinitely, without harm; in fact, the float charge extends battery life.

Features

Protection – Surge protected to IEEE and EN standards. All models include single pole cartridge type fuses mounted on the printed circuit board to protect against input or output overcurrent.

Lightweight and silent – Lighter than transformer types, completely silent but still provides full output when overloaded outlets drop AC voltage below the normal 115V.

Monitoring – Status LED indicators are provided to show the condition or charging status of the battery. When the red LED is on, it indicates that the battery is discharged and is recharging at the 'BULK' rate. When both the red and green LEDs are on, the battery is charging at the 'midrange' rate. When the green LED is on, the battery is 90% charged and ready for use.

Construction – Made using epoxy-potted cases making it the ultimate in durability, completely waterproof and able to withstand numerous caustic chemicals and gases, as well as being shockproof.

Fault Indication – The charger senses and indicates the following fault conditions: Defective or damaged cells, under-voltage at the battery, battery drawing more current than charger can replace, loss of power or extremely low AC voltage at the charger, other battery fault conditions and charger failure.

Compatibility – Works with Sealed Lead Acid (SLA), Absorbed Glass Mat (AGM) and Gel type batteries.

Low Electromagnetic and Radio

Frequency Interference – This product meets FCC class B for conducted and radiated emissions.

Listed – This product is UL listed according to the UL 1236 Standard.

Warranty – This product has a two year warranty

Specifications

Performance and physical characteristics

Output:	Nominal voltage	12 VDC
	Float voltage – 12 V batteries	13.0-13.6 VDC at 0-2 amps
	Maximum output current	6 A @ 12 VDC nom
Input:	Voltage AC	115, 208, 240 ±10%, 90-135
	Frequency	60 Hz ±5%
Battery:	Maximum battery size	150 Amp Hours
	Maximum recharge time	20 hours
Approximate net weight:		4 lbs. (1.81 Kg)
Approximate dimensions: height x width x depth-in(mm)		2.25 x 6.4 x 3.5 (57 x 162 x 89)
Ambient temperature operation: At full rated output		- 40°F to 158 °F (-40 °C to 70 °C)



Americas

1400 73rd Avenue N.E.
Minneapolis, MN 55432 USA
Phone: 763 574 5000
Fax: 763 574 5298

Europe, CIS, Middle East and Africa

Manston Park Columbus Ave.
Manston Ramsgate
Kent CT 12 5BF United Kingdom
Phone 44 1843 255000
Fax 44 1843 255902

Asia Pacific

10 Toh Guan Road #07-01
TT International Tradepark
Singapore 608838
Phone 65 6417 2388
Fax 65 6417 2399

Warning: Back feed to a utility system can cause electrocution and/or property damage. Do not connect generator sets to any building electrical system except through an approved device or after building main switch is open.

Warning: For professional use only. Must be installed by a qualified service technician. Improper installation presents hazards of electrical shock and improper operation, resulting in severe personal injury and/or property damage.

Limited Warranty

Commercial Generating Set

This limited warranty applies to all Cummins Power Generation® branded commercial generating sets and associated accessories (hereinafter referred to as "Product").

This warranty covers any failures of the Product, under normal use and service, which result from a defect in material or factory workmanship.

Warranty Period:

The warranty start date† is the date of initial start up, first rental, demonstration or 18 months after factory ship date, whichever is sooner. See table for details.

Continuous Power (COP) is defined as being the maximum power which the generating set is capable of delivering continuously whilst supplying a constant electrical load when operated for an unlimited number of hours per year. No overload capability is available for this rating.

Prime Power (PRP) is defined as being the maximum power which a generating set is capable of delivering continuously whilst supplying a variable electrical load when operated for an unlimited number of hours per year. The permissible average power output over 24 hours of operation shall not exceed 70% of the PRP. For applications requiring permissible average output higher than stated, a COP rating should be used.

Limited-Time Running Power (LTP) is defined as the maximum power available, under the agreed operating conditions, for which the generating set is capable of delivering for up to 500 hours of operation per year.

Emergency Standby Power (ESP) is defined as the maximum power available during a variable electrical power sequence, under the stated operating conditions, for which a generating set is capable of delivering in the event of a utility power outage or under test conditions for up to 500 hours of operation per year. The permissible average power output over 24 hours of operation shall not exceed 70% of the ESP.

Environmental Protection Agency – Stationary Emergency (EPA-SE) is defined as being the maximum power available during a variable electrical power sequence, under the stated operating conditions, for which a generator set is capable of delivering in the event of a utility power outage or under test conditions and used in strict accordance with the EPA NSPS for stationary engines, 40 CFR part 60, subparts IIII and JJJJ, where a reliable utility must be present. The permissible average power output over 24 hours of operation shall not exceed 70% of the EPA-SE.

Data Center Continuous (DCC) is defined as the maximum power which the generator is capable of delivering continuously to a constant or varying electrical load for unlimited hours in a data center application.

Base Warranty Coverage Duration (Whichever occurs first)

Rating	Months	Max. Hours
COP	12	Unlimited
PRP	12	Unlimited
LTP	12	500 hrs
ESP	24	1000 hrs
EPA-SE	24	Unlimited
DCC	24	Unlimited

† Warranty start date for designated rental and oil and gas model Products is determined to be date of receipt of Product by the end customer.

Cummins Power Generation® Responsibilities:

In the event of a failure of the Product during the warranty period due to defects in material or workmanship, Cummins Power Generation® will only be responsible for the following costs:

- All parts and labor required to repair the Product.
- Reasonable travel expenses to and from the Product site location.
- Maintenance items that are contaminated or damaged by a warrantable failure.

Owner Responsibilities:

The owner will be responsible for the following:

- Notifying Cummins Power Generation® distributor or dealer within 30 days of the discovery of failure.
- Installing, operating, commissioning and maintaining the Product in accordance with Cummins Power Generation®'s published policies and guidelines.
- Providing evidence for date of commissioning.
- Providing sufficient access to and reasonable ability to remove the Product from the installation in the event of a warrantable failure.
- Incremental costs and expenses associated with Product removal and reinstallation resulting from non-standard installations.
- Costs associated with rental of generating sets used to replace the Product being repaired.
- Costs associated with labor overtime and premium shipping requested by the owner.
- All downtime expenses, fines, all applicable taxes, and other losses resulting from a warrantable failure.

Limitations:

This limited warranty does not cover Product failures resulting from:

- Inappropriate use relative to designated power rating.
- Inappropriate use relative to application guidelines.
- Inappropriate use of an EPA-SE application generator set relative to EPA's standards.
- Normal wear and tear.
- Improper and/or unauthorized installation.
- Negligence, accidents or misuse.
- Lack of maintenance or unauthorized repair.
- Noncompliance with any Cummins Power Generation® published guideline or policy.
- Use of improper or contaminated fuels, coolants or lubricants.
- Improper storage before and after commissioning.
- Owner's delay in making Product available after notification of potential Product problem.
- Replacement parts and accessories not authorized by Cummins Power Generation®.
- Use of Battle Short Mode.
- Owner or operator abuse or neglect such as: operation without adequate coolant or lubricants; overfueling; overspeeding; lack of maintenance to lubricating, cooling or air intake systems; late servicing and maintenance; improper storage, starting, warm-up, run-in or shutdown practices, or for progressive damage resulting from a defective shutdown or warning device.

- Damage to parts, fixtures, housings, attachments and accessory items that are not part of the generating set.

This limited warranty does not cover costs resulting from:

- Difficulty in gaining access to the Product.
- Damage to customer property.

A "Data center" is defined as a dedicated facility that house computers and associated equipment for data storage and data handling.

Reliable utility is defined as utility power without routine or regularly scheduled black-outs.

Please contact your local Cummins Power Generation® Distributor for clarification concerning these limitations.

CUMMINS POWER GENERATION® RIGHT TO FAILED COMPONENTS:

Failed components claimed under warranty remain the property of Cummins Power Generation®. Cummins Power Generation® has the right to reclaim any failed component that has been replaced under warranty.

Extended Warranty:

Cummins Power Generation® offers several levels of Extended Warranty Coverage. Please contact your local Cummins Power Generation® Distributor for details.

www.power.cummins.com

THE WARRANTIES SET FORTH HEREIN ARE THE SOLE WARRANTIES MADE BY CUMMINS POWER GENERATION® IN REGARD TO THE PRODUCT. CUMMINS POWER GENERATION® MAKES NO OTHER WARRANTIES, EXPRESS OR IMPLIED, OR OF MERCHANTABILITY OR FITNESS FOR A PARTICULAR PURPOSE.

IN NO EVENT IS CUMMINS POWER GENERATION® LIABLE FOR INCIDENTAL OR CONSEQUENTIAL DAMAGES.

This limited warranty shall be enforced to the maximum extent permitted by applicable law. This limited warranty gives the owner specific rights that may vary from state to state or from jurisdiction to jurisdiction.

Product Model Number: _____
 Product Serial Number: _____
 Date in Service: _____