



# E91 Online UPS

10kVA, 15kVA, 20kVA, 30kVA, 40kVA Models

User & Installation Manual

## Table of Contents

<b>1. SAFETY AND EMC INSTRUCTIONS.....</b>	<b>3</b>
1-1. TRANSPORTATION AND STORAGE.....	3
1-2. PREPARATION.....	3
1-3. INSTALLATION.....	3
1-4. CONNECTION WARNINGS.....	4
1-5. OPERATION.....	5
1-6. STANDARDS.....	5
<b>2. INSTALLATION AND OPERATION.....</b>	<b>6</b>
2-1. UNPACKING AND INSPECTION.....	6
2-2. UPS FLOOR-ANCHORING.....	6
2-3. WIRING TERMINAL VIEW.....	7
2-4. OPERATION PRINCIPLE.....	9
2-5. SINGLE UPS INSTALLATION.....	9
2-6. UPS INSTALLATION FOR PARALLEL SYSTEM.....	12
2-7. SOFTWARE INSTALLATION.....	14
<b>3. OPERATION.....</b>	<b>14</b>
3-1. INITIAL OPERATION.....	14
3-2. LED INDICATORS AND LCD PANEL.....	14
3-3. SCREEN DESCRIPTION.....	14
3-4. AUDIBLE ALARM.....	41
3-5. SINGLE UPS OPERATION.....	42
3-6. PARALLEL OPERATION.....	44
3-7. FAULT CODE.....	46
3-8. WARNING CODE.....	47
<b>4. TROUBLE SHOOTING.....</b>	<b>48</b>
<b>5. STORAGE AND MAINTENANCE.....</b>	<b>49</b>
5-1. STORAGE.....	49
5-2. MAINTENANCE.....	49
<b>6. SPECIFICATIONS.....</b>	<b>51</b>

## 1. Safety and EMC instructions

All safety instructions in this document must be read, understood and followed.

### 1-1. Transportation and Storage



- Please transport the UPS system only in the original packaging to protect against shock and damage.
- The UPS must be stored in the room where the temperature is well regulated. Ambient temperature should not exceed 40°C.

### 1-2. Preparation

- Condensation may form if the UPS system is moved immediately from cold to warm environment. The UPS system must be absolutely dry before being installed. Please allow at least two hours for the UPS system to acclimate the environment.
- Do not install the UPS system near water or in moist environments.
- Do not install the UPS system where it would be exposed to direct sunlight or nearby heat source.
- Do not block ventilation holes on the UPS housing.

### 1-3. Installation

- Do not connect appliances or devices which would overload the UPS (e.g. big motor-type equipment) to the UPS output terminal.
- Place cables in such a way that no one can step on or trip over them.
- Do not block air vents on the housing of the UPS. Ensure proper unit spacing of ventilation.
- UPS came equipped with grounding terminal, in the final installation phase, connect grounding/ earthing wire to the external UPS battery cabinets or appropriate grounding terminals.
- The UPS can be installed only by qualified maintenance personnel.
- An appropriate disconnect device such as short-circuit backup protection should be incorporated during installation.
- An integral emergency shutoff switch which prevents additional load from the UPS in any mode of operation should be implemented during the installation.
- Secure the grounding/earthing wire before connecting to any live wire terminal.
- Installation and Wiring must be in accordance with the local electrical laws and regulations.

## 1-4. Connection Warnings

In accordance with safety standard, installation has to be provided with a [Backfeed Protection] system, as for example a contactor, which will prevent the appearance of voltage or dangerous energy in the input mains during a mains fault. There is no standard backfeed protection inside of the UPS. However, there are relays on the Input to cut off line voltage and while the neutral is still connect to UPS.

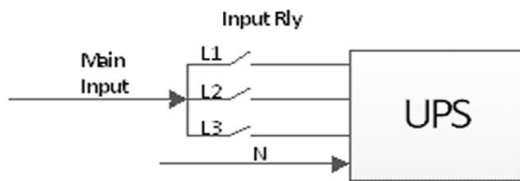

Input relay diagram

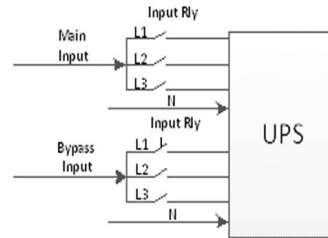

Input relay diagram for dual-input model

There can be no derivation in the line that goes from the «Backfeed Protection» to the UPS, as the standard safety would be infringed.

- Warning labels should be placed on all primary power switches installed in places away from the unit to alert the electrical maintenance personnel of the presence of a UPS in the circuit. The label will bear the following or an equivalent text:

Before working on this circuit  
Isolate Uninterruptible Power Supply (UPS)  
Then check for Hazardous Voltage between all terminals including the protected earth  
**Risk of Voltage Backfeed**

- The power input for this unit must be three-phase rated in accordance with the equipment nameplate. It also must be suitably grounded.

**WARNING**  
**HIGH LEAKAGE CURRENT**  
**EARTH CONNECTION ESSENTIAL**  
**BEFORE CONNECTING SUPPLY**

- This UPS should be connected with TN grounding/earthing system.
- Use of this equipment in medical instrument of any life-sustaining equipment where failure of this equipment can reasonably be expected to cause the failure of the life-sustaining equipment or to significantly affect its safety or effectiveness is not recommended. Do not use this equipment in the presence of a flammable mixture with air, oxygen or nitrous oxide.
- Connect grounding terminal of UPS to a grounding electrode conductor.

### 1-5. Operation

- Do not disconnect the grounding/earthing conductor cable on the UPS or the building wiring terminals under any circumstance.
- The UPS system features its own, internal current source (batteries). The UPS output sockets or output terminal blocks may be electrically live even if the UPS system is not connected to the building mains/live wires. (only for standard models)
- In order to fully disconnect the UPS system, first press the “OFF” button and then disconnect the mains/live wires.
- Ensure that no liquid or other foreign objects can enter into the UPS system.
- The UPS can be operated by any individuals with no previous experience.

### 1-6. Standards

* Safety	
UL 1778, CSA C22.2 No.107.3-14	
* EMI	
Conducted Emission.....: FCC Part 15, Subpart B	Class A
Radiated Emission.....: FCC Part 15, Subpart B	Class A

**NOTE:**

This equipment has been tested and found to comply with the limits for a Class A digital device, pursuant to part 15 of the FCC Rules. These limits are designed to provide reasonable protection against harmful interference when the equipment is operated in a commercial environment. This equipment generates, uses, and can radiate radio frequency energy and, if not installed and used in accordance with the instruction manual, may cause harmful interference to radio communications. Operation of this equipment in a residential area is likely to cause harmful interference in which case the user will be required to correct the interference at his own expense.

## 2. Installation and Operation

We offer optional parallel function upon request. The UPS with parallel function is called the "Parallel model". We have detail installation and operation procedure of the Parallel Model in the following chapter.

### 2-1. Unpacking and Inspection

Unpack the package and check the package contents. The shipping package should contain:

- One UPS
- One user manual
- One monitoring software CD
- One USB cable
- One parallel cable (option)
- One shared current cable (option)

NOTE: Before the installation, please inspect the unit. Be sure that there is no physical damage to the unit. Do not turn on the unit and notify the carrier and dealer immediately if there is any damage or missing parts and accessories. Please keep the original packaging for future use. It is recommended to keep each equipment and battery set in their original packaging because they have been designed to provide maximum protection during transportation and storage.

### 2-2. UPS Floor-Anchoring

NOTICE: The L-shaped floor anchoring brackets that secured the enclosure to the pallet during shipment may be used for a stand-alone UPS enclosure to enhance stability.

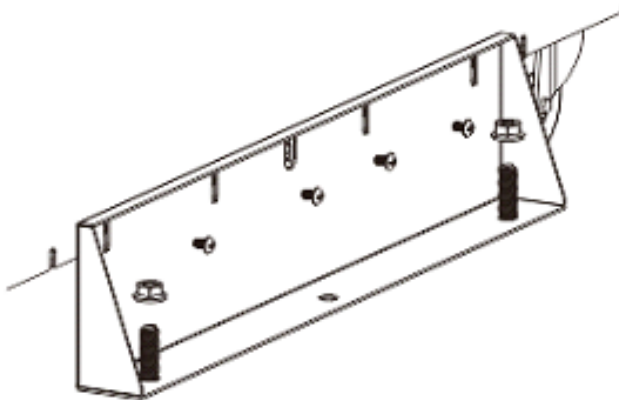

### 2-3. Wiring Terminal View E91 units with internal batteries

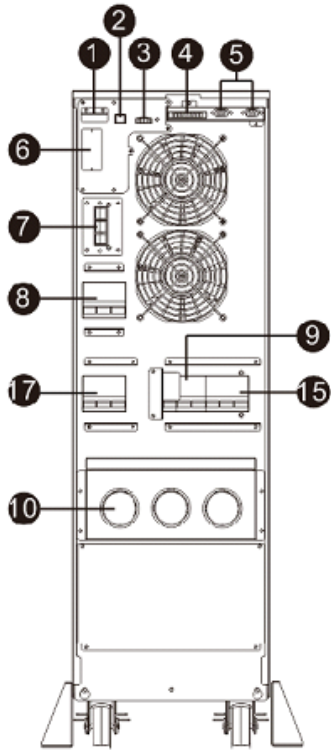

E91-10K Rear Panel

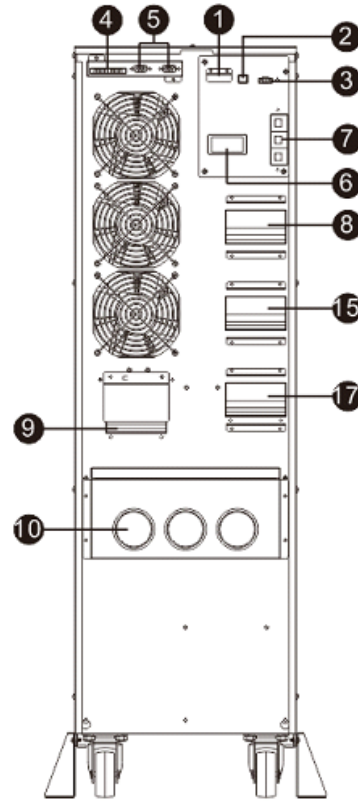

E91-15K/20K Rear Panel

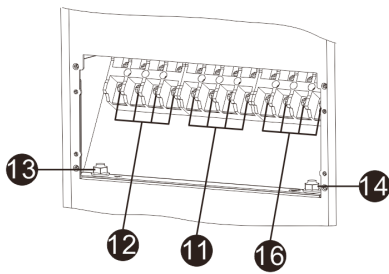

E91-10K Input/Output Terminal

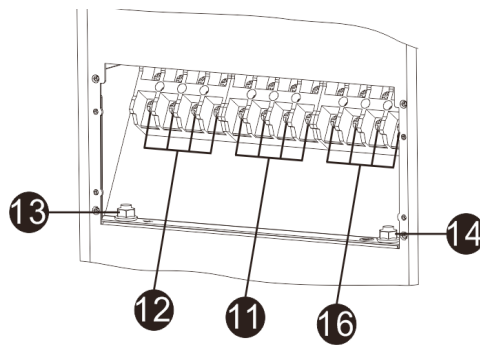

E91-15K/20K Input/Output Terminal

### E91 units with internal batteries

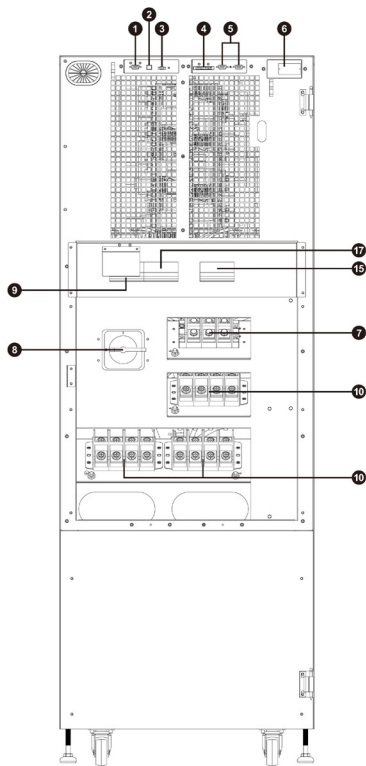

E91-30/40K front view door removed

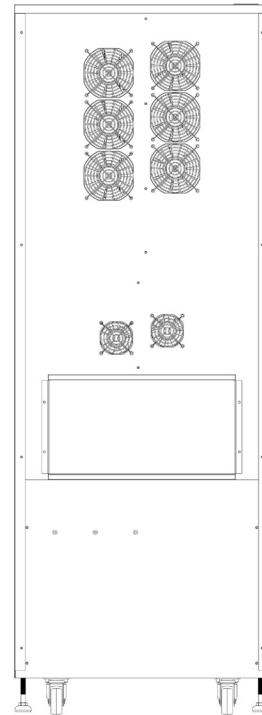

E91-30/40K rear view

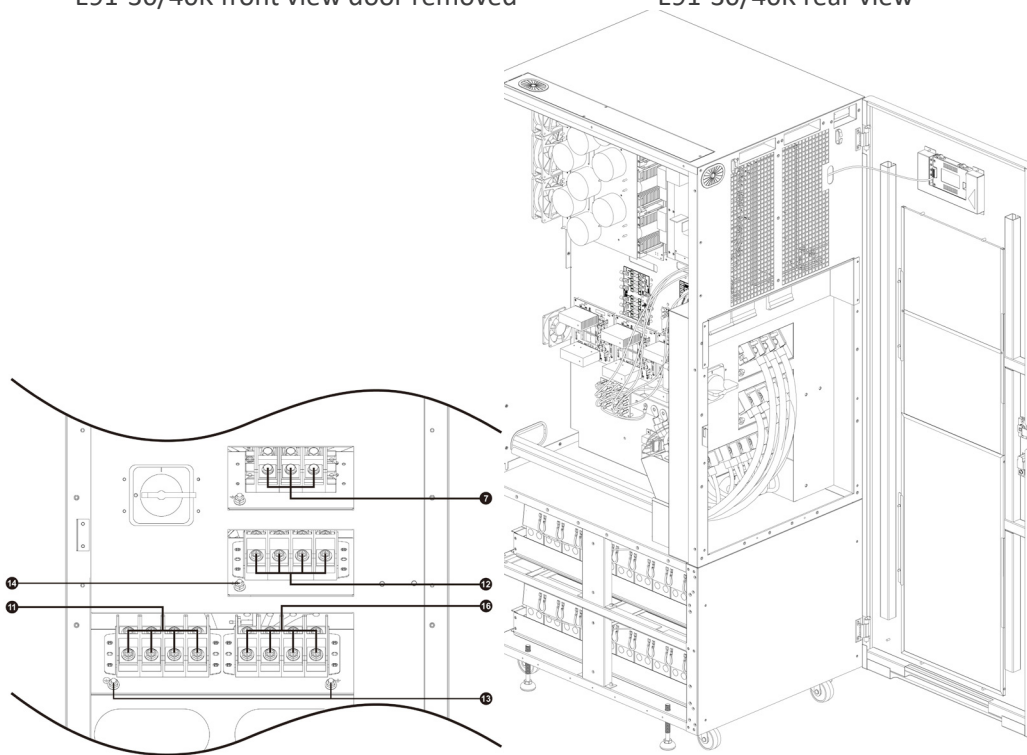

E91-30/40K wiring panels

E91-30/40k cable routing diagram



1. RS-232 communication port (only for firmware updates)
2. USB communication port
3. Emergency power off function connector (EPO connector)  
    Note: Keep the EPO connector closed for UPS normal operation.  
    To activate EPO function, please remove the jumper
4. Share current port
5. Parallel port
6. Intelligent slot
7. External battery connector
8. Line input circuit breaker/switch
9. Maintenance bypass switch
10. Input/Output terminal (Refer to the diagram for the details)
11. Line input terminal
12. Output terminal
13. Input grounding terminal
14. Output grounding terminal
15. Bypass input circuit breaker/switch
16. Bypass input terminal
17. Output circuit breaker

**2-4. Operation Principle**

The operating principle of the UPS is shown as below.

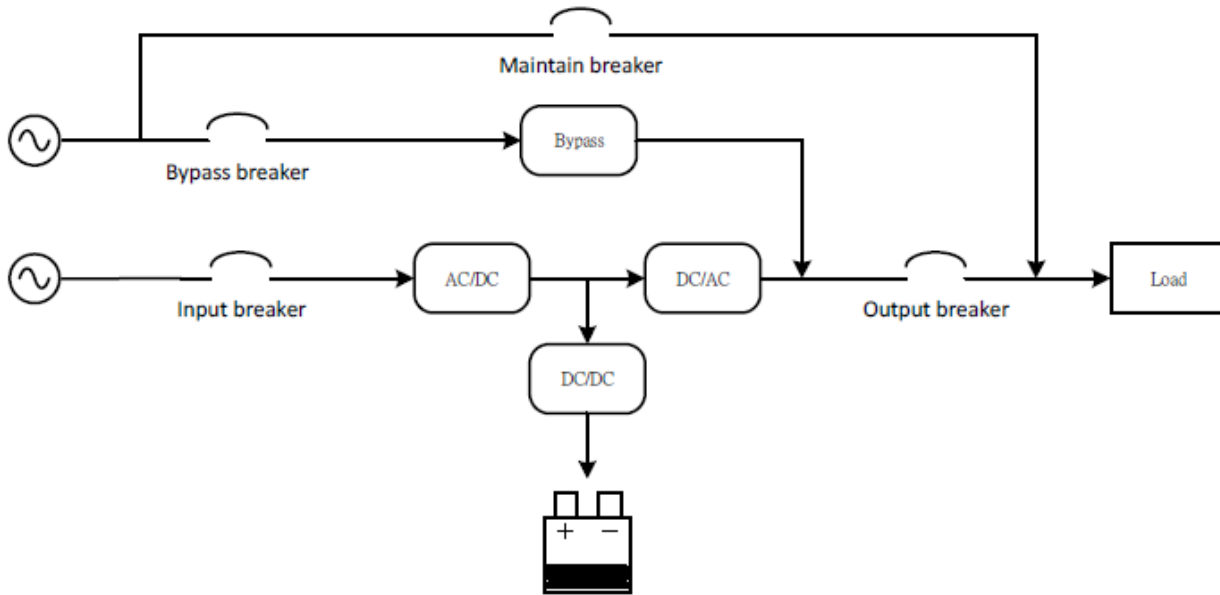

**2-5. Single UPS Installation**

Installation and wiring must be carried out in accordance with the local electric laws and regulations by trained professionals.

1) Make sure that the mains wire and breakers of the building are rated for the capacity of the UPS to prevent electric shock or risk of fire.

NOTE: Do not use the wall receptacle as the input power source for the UPS, as its rated current is less than the UPS's maximum input current. The receptacle may be damaged and destroyed.

- 2) Switch off the mains switch in the building before installation.
- 3) Turn off all the connected devices before connecting to the UPS.
- 4) Prepare wires based on the following table:

**CAUTION** - To reduce the risk of fire, AC input terminals of each UPS should be connected to branch circuit breaker with maximum overcurrent protection in accordance with the National Electric Code, ANSI/NFPA 70 as below table.

Model	E91-10K	E91-15K	E91-20K	E91-30K	E91-40K
Wiring (AWG)	6	4	2	2/0	3/0
Torque force (lb-in)	17.71	26.56		AC:60	
				DC:132.8	
AC Input Protection Device	63A	80A	100A	150A	200A
AC Output Protection Device	30A	50A	60A	100A	150A

NOTE 1: The selections for color of wires should be followed by the local electrical laws and regulations.

NOTE 2: Only use 90°C copper wires.

NOTE 3: Ring terminal of PE stud size shall be minimum 8mm and can be connected to minimum AWG copper wire noted above

5) Remove the terminal block cover at the rear panel of UPS. Then, connect the wires according to the following terminal block diagrams. (Connect the grounding/earthing wire first when making other wire connections. Remove the grounding/earthing wire last when connecting the UPS!)

**NOTE:** For single utility power system, connect input terminals to the AC power source and use supplied jumper wire to connect input and bypass input together (shows dashed line in below wiring diagrams)

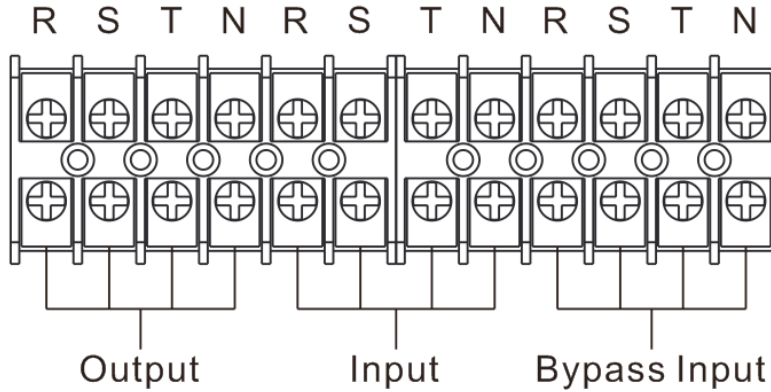

Terminal block wiring diagram for 10K

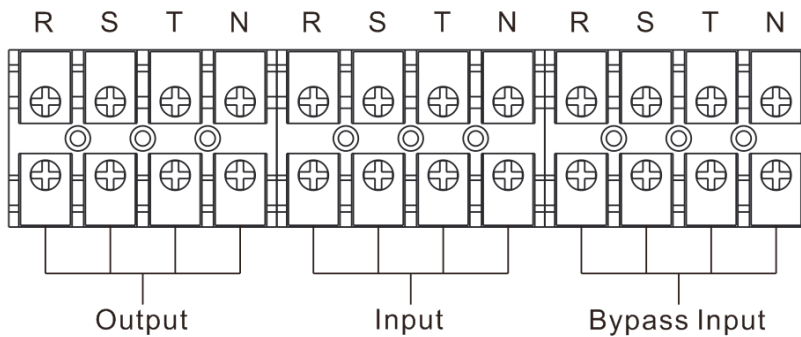

Terminal block wiring diagram for 15K/20K

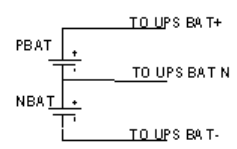
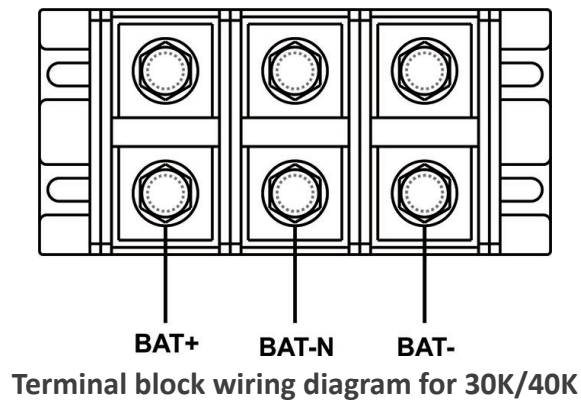
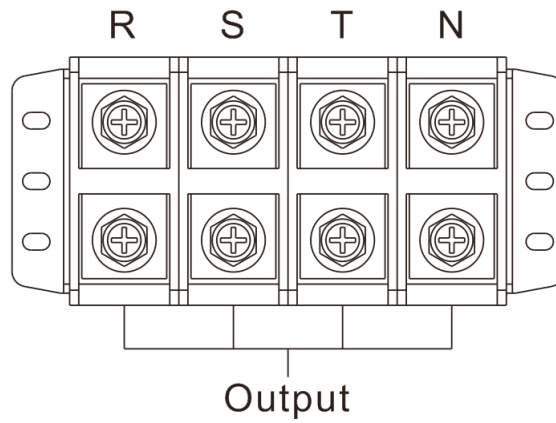
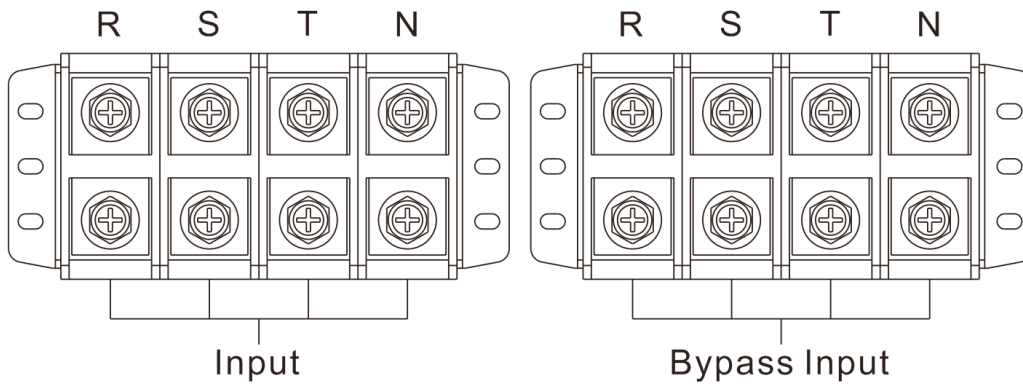

**Battery connection wiring**

**NOTE 1:** Make sure that the wires are connected securely with the terminals.

**NOTE 2:** Please install the output breaker between the output terminal and the load, and the breaker should have leakage current protective function if necessary.

6) Put the terminal block cover back at the rear panel of the UPS.

**Warning:** (Only for standard model)

- Make sure the UPS is off before the installation. The UPS should not be turned on during wiring connection.
- Do not attempt to modify the standard model into the long-run model. In particular, do not try to connect the standard internal battery to the external battery. The battery type and voltage may be different, risk of electric shock or fire may occurred!

**Warning:** (Only for long-run model)

- Make sure a DC breaker or other protective device between UPS and the external battery pack is installed for added safety. If not, please install it carefully. Switch off the battery breaker before installation. NOTE: Set the battery pack breaker in "OFF" position and then install the battery pack.
- Pay special attention to the rated battery voltage marked on the rear panel. If you want to change the numbers of the battery in a chain, make sure you modify the UPS setting accordingly. Connection with wrong battery voltage may cause irreversible damage of the UPS.
- Pay special attention to the polarity marking on external battery terminal block. Connection with wrong battery voltage may cause irreversible damage of the UPS.
- Make sure the protective grounding/earthing wiring is adequate. The current spec, color, position, connection and conductance reliability of the wire should be verified.
- Make sure the utility input & output wiring is rated correctly. The current spec, color, position, connection and conductance reliability of the wire should be verified. Make sure the L/N side is correct, not reverse or short-circuited.

## 2-6. UPS Installation for Parallel System

If the UPS is only for single operation, you may skip this section.

- 1) Install and wired the UPS according to the section 2-5.
- 2) Connect the output wires of each UPS to an output breaker.
- 3) Connect all output breakers to a centralize breaker. This centralize output breaker will then connect directly to the loads.
- 4) Either common battery packs or independent battery packs for each UPS are allowed.
- 5) Refer to the following wiring diagram for input, output and bypass input:

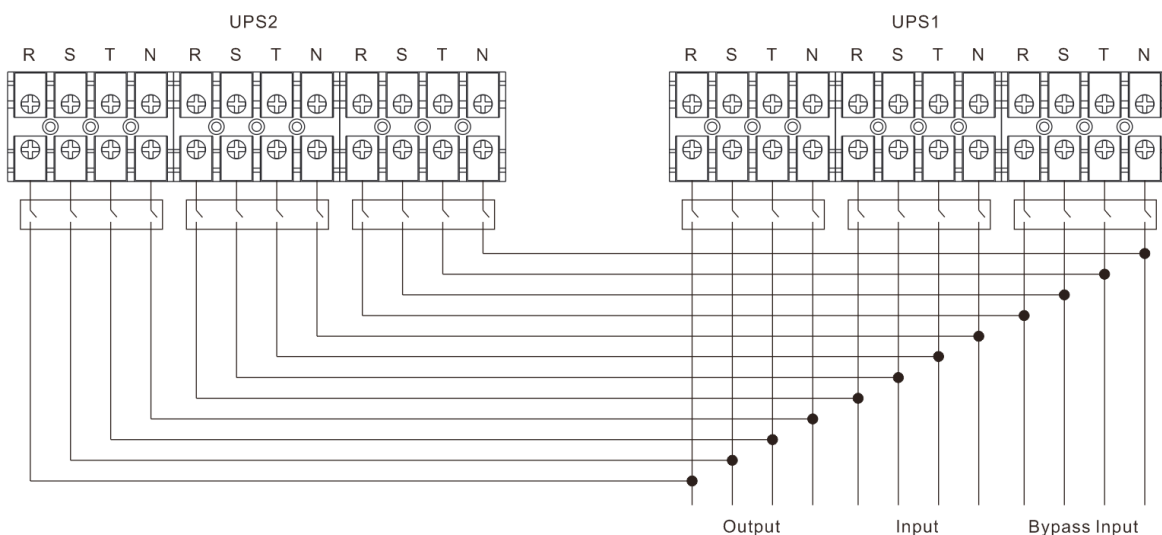

**Wiring diagram of parallel system for 10K/15K/20K**

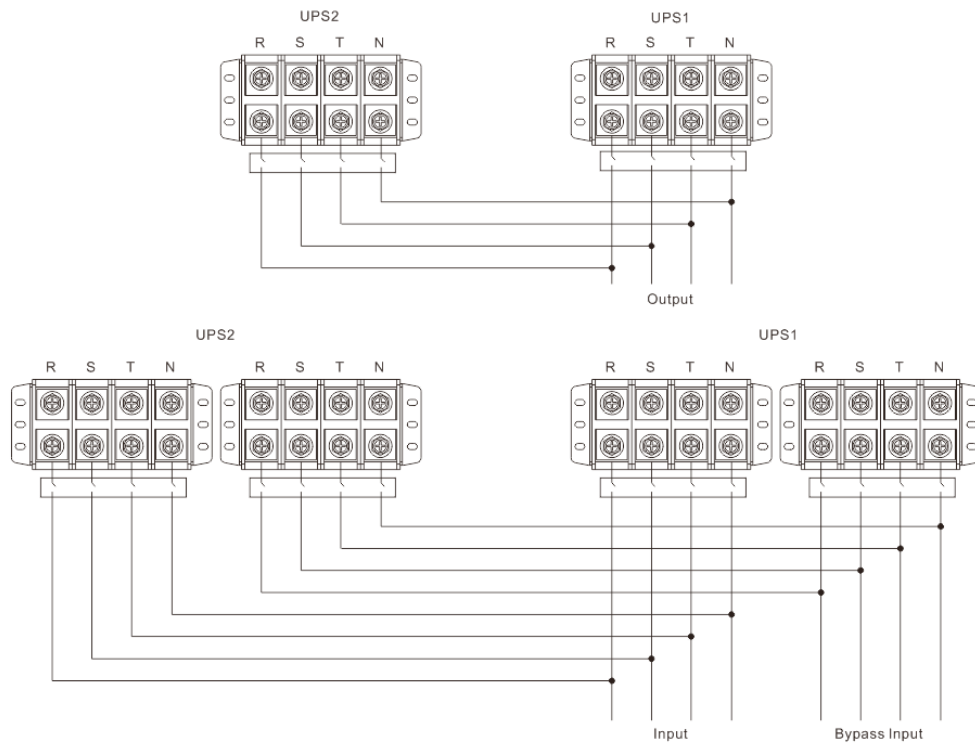

Wiring diagram of parallel system for 30K/40K

6) Refer to the following communication wiring diagrams for share current cable and parallel cable connections.

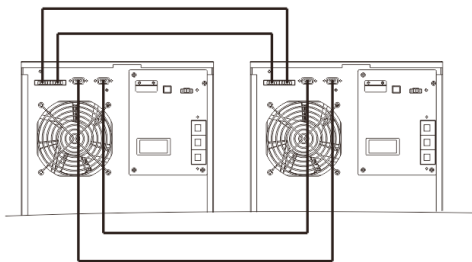

Diagram 1: Two UPSs in parallel

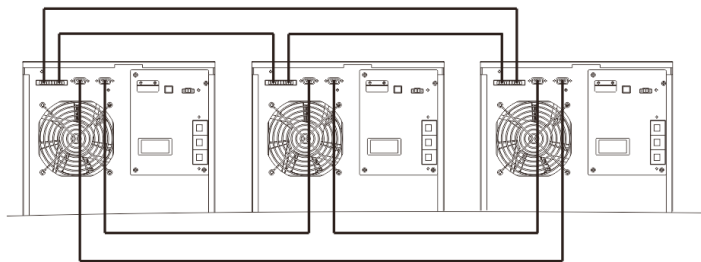

Diagram 2: Three UPS in parallel

**Parallel system for 10K/15K/20K**

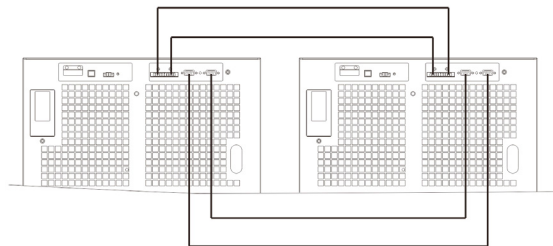

Diagram 1: Two UPSs in parallel

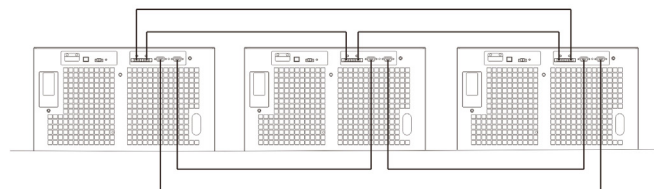

Diagram 2: Three UPS in parallel

**Parallel system for 30K/40K**

## 2-7. Software Installation

For optimal computer system protection, install UPS monitoring software to configure UPS shutdown operation.

## 3. Operation

### 3-1. Initial Operation

- 1) Before operation, make sure that the two strings of batteries are connected correctly in order of "+,GND,-" terminals and the breaker of the battery pack is at "ON" position (only for long-run model).
- 2) Press the "POWER" button to set up the power supply for the UPS. UPS will enter to power on mode. After initialization, UPS will enter to "No Output mode".

### 3-2. LED Indicators and LCD Panel

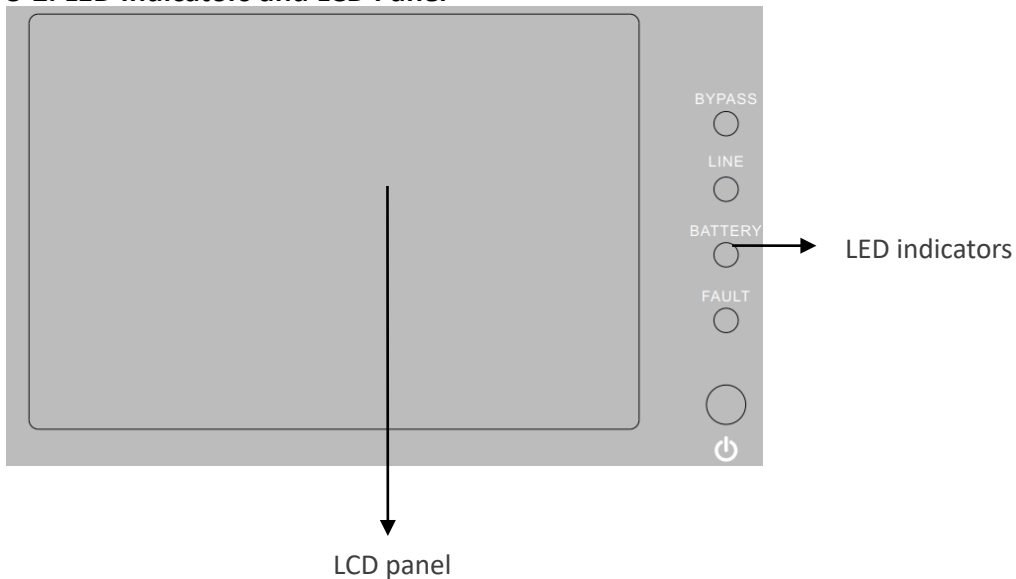

LED Indicators:

There are 4 LEDs on front panel to show the UPS working status:

Mode / LED	Bypass	Line	Battery	Fault
UPS On	●	●	●	●
Standby mode	○	○	○	○
Bypass mode	●	○	○	○
Line mode	○	●	○	○
Battery mode	○	○	●	○
CVCF mode	○	●	○	○
Battery Test	●	●	●	○
ECO mode	●	●	○	○
Fault	○	○	○	●

Note: ● means LED is lighting, and ○ means LED is faded.

### 3-3. Screen Description

After initialization, the LCD will display main screen. There are five sub-menus: Control, measure, setting, information and data log. Touch any sub-menu icon to enter into the sub-screen.

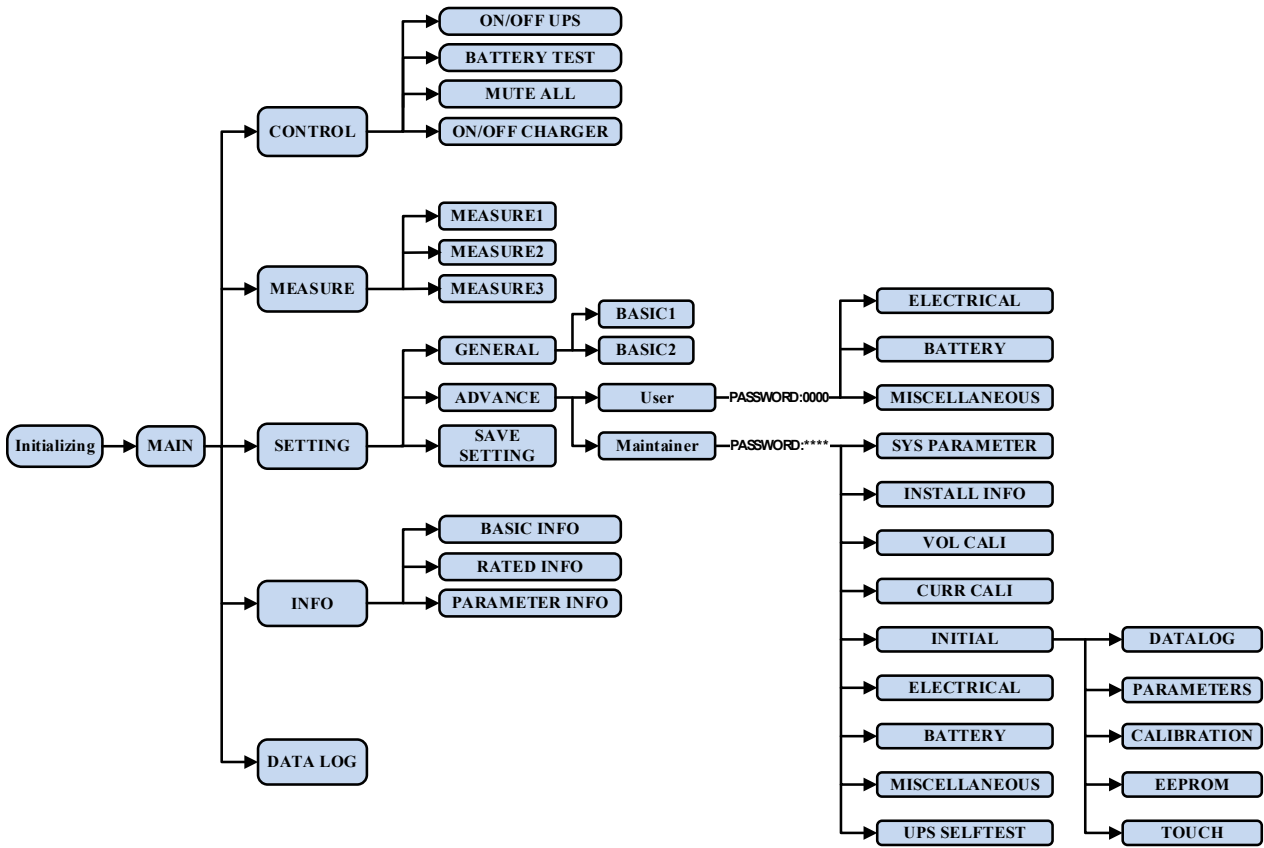

Menu tree

**3-3-1. Main screen**

Upon powering on, the LCD will start initialization approximately few seconds as shown below.

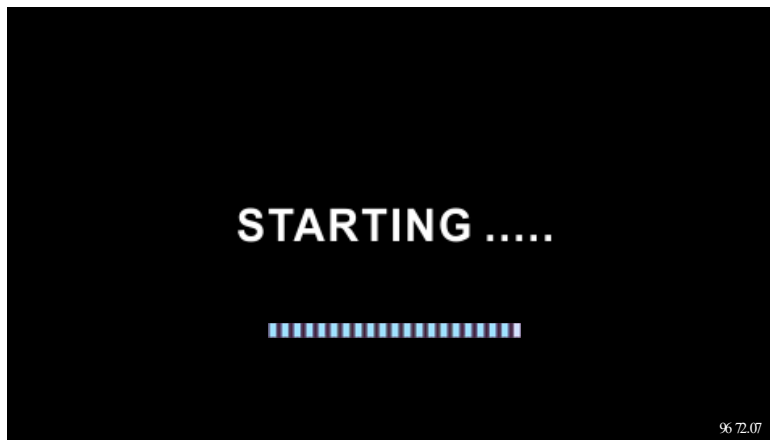

After initialization, the main screen will display as shown below. On the bottom, there are five icons to represent five sub-menus: CONTROL, MEASURE, SETTING, INFO, DATALOG.



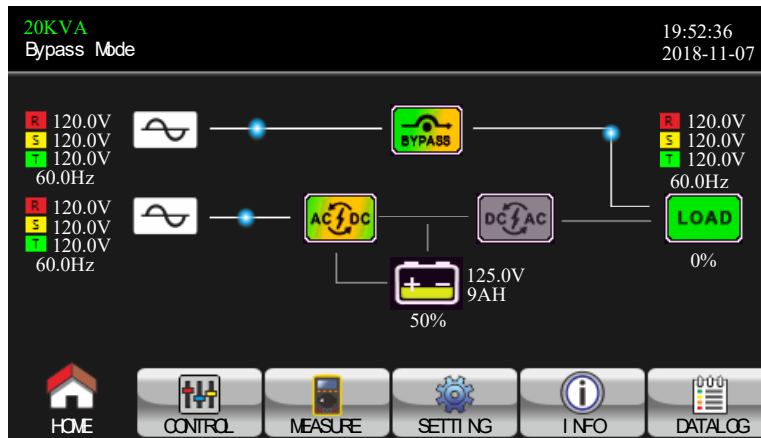

**3-3-2. Control screen**

Touch the icon  to enter control sub-menu.



Touch  icon to return back to main screen no matter it's in any screen of any submenu.

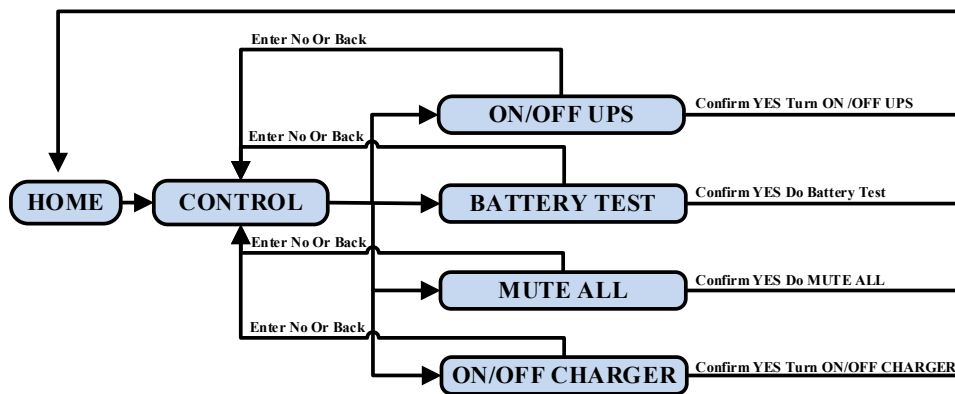

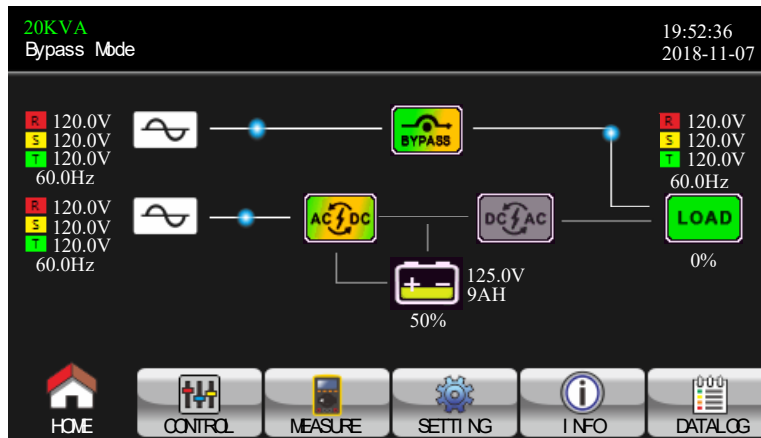

**Control screen**

Touch the icon  to enter control sub-menu.

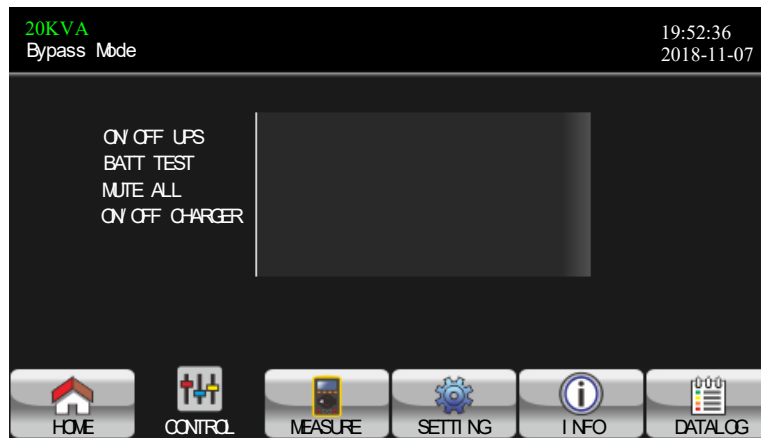

Touch  icon to return back to main screen no matter it's in any screen of any submenu.

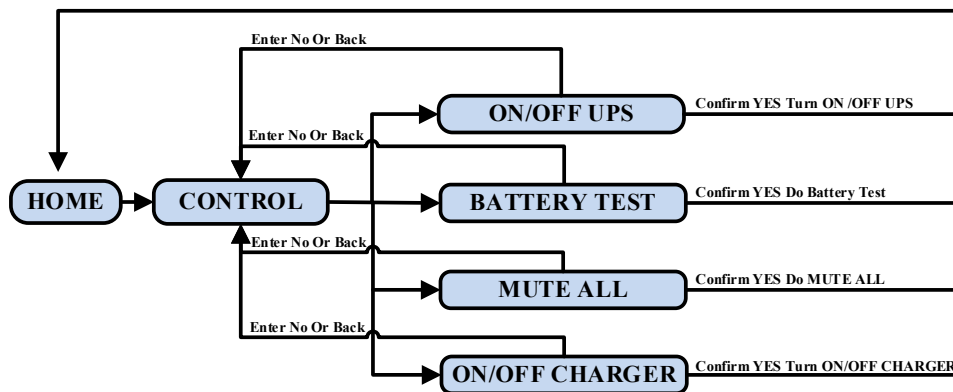

Screen 1.0 «Control» and its sub-menus

## On/Off UPS

It will show "Turn on UPS?" when UPS is off.

It will show "Turn off UPS?" when UPS is on.

Touch "YES" to turn on or off the UPS. Then, the screen will return to main screen

Touch "Back" to return to main screen immediately or "No" to cancel this operation and back o main screen.



TURN ON UPS



TURN OFF UPS

## Battery Test

It will show "Battery Test" if the UPS is not in test. Touch "Yes" to start battery test. Then, it will show "Battery testing....." during battery test period. After few seconds, battery test result will show on the screen. Touch "Back" to return to main screen immediately or "No" to cancel this operation and back to main screen.

It will show "Cancel battery test" if the UPS is in test.



Battery Test



Cancel Battery Test

## Audio mute

It will show "Mute all" if the audio is active. Touch "Yes" to activate mute. If "Mute all" is active, I will show  icon on the top left corner of the main screen. Touch "Back" to return to CONTROL screen immediately or "No" to cancel this operation and back to CONTROL screen.

It will show "Cancel mute" if the UPS is mute already. Touch "Yes" activate audio function or "No" to keep mute. Touch "Back" to return to CONTRL screen.



Mute All

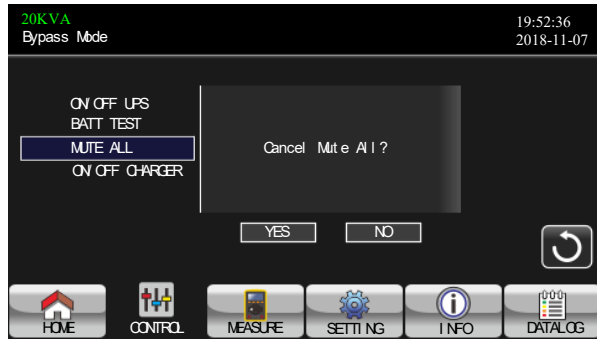

Cancel Mute all

### On/Off Charger

It will show "Turn on Charger?" when charger is off.

It will show "Turn off Charger?" when charger is on.

Touch "YES" to turn on or off the charger. Then, the screen will return to main screen.

Touch "Back" to return to CONTROL screen immediately or "No" to cancel this operation and back to CONTROL screen.

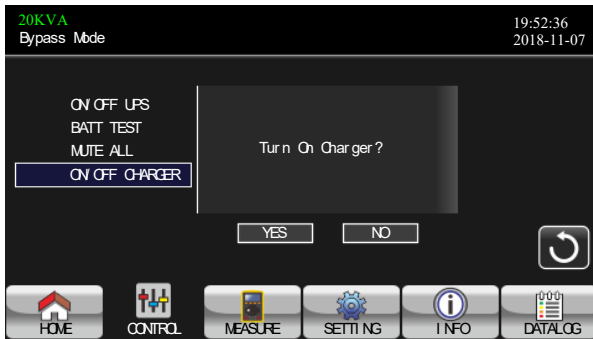



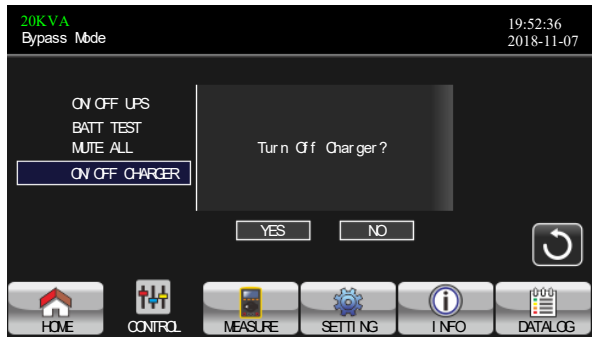

TURN ON CHARGER



TURN OFF CHARGER

### 3-3-3 Measure screen

Touch the icon  to enter measure page. Touch the icon  or  to browse information. Touch the icon  to return to main screen. Touch the icon  to go back to previous menu.



Measure screen page 1

The paralleled UPS behaves as one large UPS system but with the advantage of presenting larger capacity and

- LINE VOL: The real time value of R, S and T phase voltage, RS, ST, TR voltage and input frequency.
- INVERTER VOL: The real time value of R, S and T inverter voltage, RS, ST and TR voltage and frequency.
- BYPASS VOL: The real time value of R, S and T bypass voltage, RS, ST and TR voltage and frequency.
- OUTPUT VOL: The real time value of R, S and T output voltage, RS, ST and TR voltage and frequency.

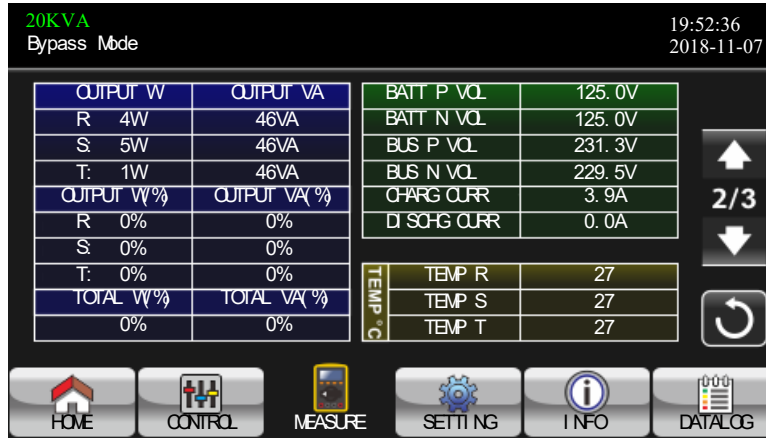

Measure screen page 2

- OUTPUT W: R, S and T output power in watt.
- OUTPUT VA: R, S and T output power in VA.
- OUTPUT W (%): R, S and T output power watt in percentage.
- OUTPUT VA (%): R, S and T output power VA in percentage.
- Total watt and VA: Total output load in watt and VA.
- BATT Voltage/Bus Voltage/Charging Current/Discharging Current: The real time value of DC related information.
- Temperature: Temperature of R, S and T phases.

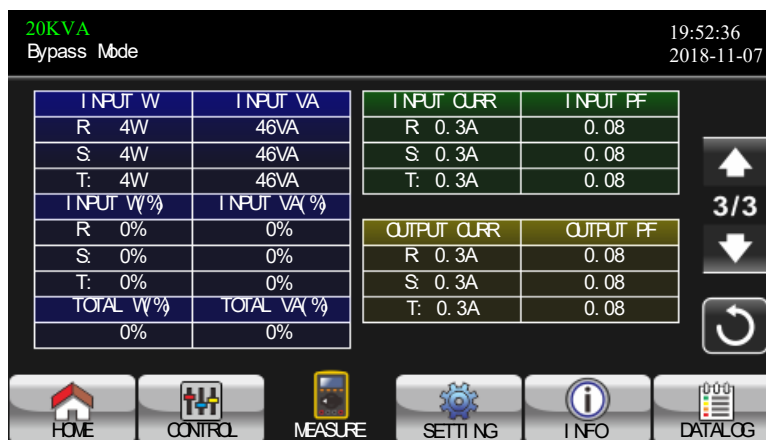



Measure screen page 3

- INPUT W: R, S and T input power in watt.
- INPUT VA: R, S and T input power in VA.
- INPUT W (%): R, S and T input power watt in percentage.
- INPUT VA (%): R, S and T input power VA in percentage.
- Input current: The real-time value of input current in R, S and T phases.
- Output current: The real-time value of output current in R, S and T phases.

### 3-3-4. Setting screen

This sub-menu is used to set the parameters of UPS. Touch the icon  to enter setting menu page. There are

2 options: Basic and Advanced. Touch the icon  to return to main screen. Touch the icon  to go back to previous menu.

NOTE: Not all settings are available in every operation mode. If the setting is not available in present mode, the LCD will keep its original setting parameter showed instead of changing the parameters.

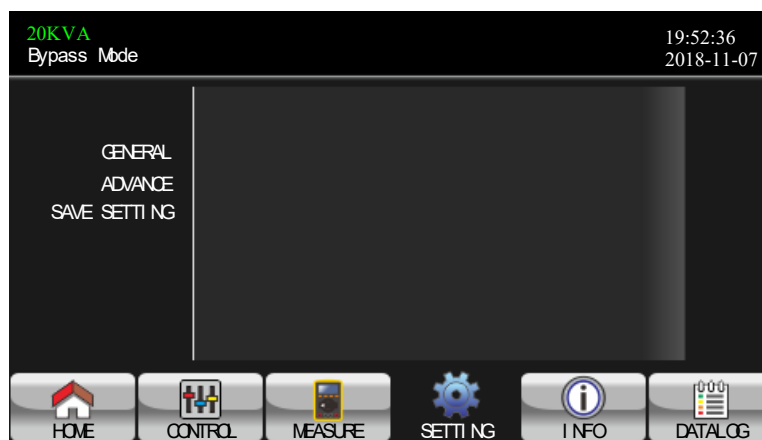

Setting screen

- GENERAL: It's to set up basic information of the UPS. It's not related to any function parameter.
- ADVANCE: It's required to enter password to access to the "ADVANCE" setting. There are two types of authority, User and Maintainer.
- SAVE SETTING: Select this function save the setting(s) when it's done. Click this tap to execute saving function no matter if UPS is connected to battery or not. However, it's requested to shut down the UPS to complete setting changes.

The authority list:

Setting item	UPS operation Mode	Standby Mode	Bypass Mode	Line Mode	Battery Mode	Battery Test Mode	Fault Mode	Converter Mode	ECO Mode	Authorization			
										No Password	User	Maintainer	
GENERAL	Date/Time	Y	Y	Y	Y	Y	Y	Y	Y	Y			
	Language	Y	Y	Y	Y	Y	Y	Y	Y	Y			
	Input Source	Y	Y							Y			
	Contact	Y	Y	Y	Y	Y	Y	Y	Y	Y			
	Phone	Y	Y	Y	Y	Y	Y	Y	Y	Y			
	Mail	Y	Y	Y	Y	Y	Y	Y	Y	Y			
	Audio Alarm	Y	Y	Y	Y	Y	Y	Y	Y	Y			
	Energy Star	Y	Y								Y		
ADVANCE	Output Voltage	Y	Y								Y	Y	
	Output Frequency	Y	Y								Y	Y	
	CVCF Mode	Y	Y								Y	Y	
	Bypass Forbid	Y	Y	Y	Y	Y		Y	Y		Y	Y	
	Bypass Mode	Y	Y	Y	Y	Y		Y	Y		Y	Y	
	Bypass Voltage Range	Y	Y								Y	Y	
	Bypass Frequency Range	Y	Y								Y	Y	
	ECO Mode	Y	Y								Y	Y	
ADVANCE	Battery	Warning Voltage	Y	Y	Y	Y		Y	Y		Y	Y	
		Shutdown Voltage	Y	Y	Y	Y	Y		Y	Y		Y	Y
		Age Alert	Y	Y	Y	Y	Y		Y	Y		Y	Y
		Capacity in Ah	Y	Y	Y	Y	Y		Y	Y		Y	Y
	Auto-Restart	Y	Y	Y	Y	Y		Y	Y		Y	Y	
	System Shutdown Time	Y	Y	Y	Y	Y	Y	Y	Y		Y	Y	
	System Restore Time	Y	Y	Y	Y	Y	Y	Y	Y		Y	Y	
	Password setting	Y	Y	Y	Y	Y	Y	Y	Y		Y	Y	
	Default User password	Y	Y	Y	Y	Y	Y	Y	Y			Y	
	Model Name	Y	Y	Y	Y	Y	Y	Y	Y			Y	
	Serial Number	Y	Y	Y	Y	Y	Y	Y	Y			Y	
	Manufacturer	Y	Y	Y	Y	Y	Y	Y	Y			Y	
	Max charging current	Y	Y	Y	Y	Y		Y	Y			Y	
	Battery Number	Y	Y	Y	Y	Y		Y	Y			Y	
	Charge Voltage	Y	Y	Y	Y	Y		Y	Y			Y	
	Charger Number	Y	Y	Y	Y	Y		Y	Y			Y	
	Float Voltage	Y	Y	Y	Y	Y		Y	Y			Y	
	UPS Type	Y											
	System Install Date	Y	Y	Y	Y	Y	Y	Y	Y			Y	
	Battery Install Date	Y	Y	Y	Y	Y	Y	Y	Y			Y	
Voltage Calibration			Y				Y				Y		
Current Calibration		Y	Y				Y				Y		
Clean Data log	Y	Y	Y	Y	Y	Y	Y	Y			Y		
Reset parameters	Y	Y									Y		
Reset Calibration	Y	Y									Y		
Reset EEPROM	Y	Y									Y		
Touch Calibration	Y	Y	Y	Y	Y	Y	Y	Y			Y		
UPS Selftest	Y										Y		
Save Setting	Y	Y								Y	Y	Y	

## GENERAL

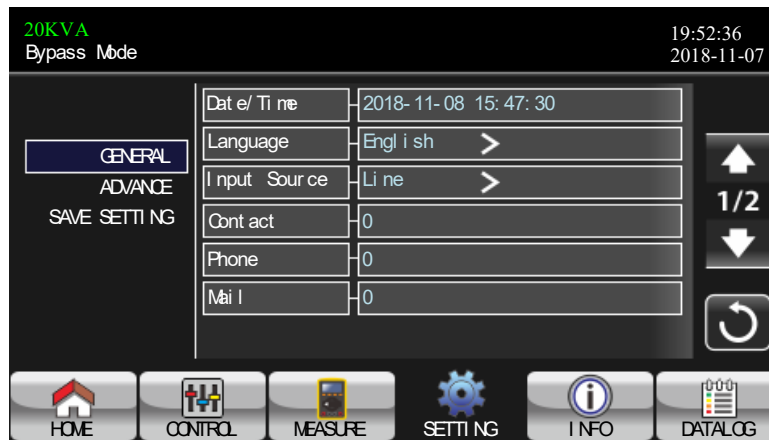

General screen page 1

- Date/Time: Set the date and time. The format is YYYY-MM-DD HH:MM:SS. The calendar day will be automatically changed when the year, month and date are set.
- Language: Set the LCD language. Only English is available.
- Input Source: Select the input source. There are two options: Line (utility) and generator. Line is default setting. This setting value will show on the main page. When "generator" is selected, the acceptable input frequency will be fixed at the range of 40~75Hz. This setting value will show on the status bar.
- Service Contact: Set the name of contact person and the maximum length is 18 characters.
- Service Phone: Set the service phone number. Only 0~9, + and – are accepted. The maximum length is 14 characters.
- Service Mail: Set the service email accounts up to two and the maximum length is 36 characters.



General screen page 2



- Audio Alarm: There are two events available to mute. You may choose “Enable” or “Disable” alarm when related events occur.
- Enable: When selected, alarm will be mute when related events occur. Enable is the default setting.
- Disable: When selected, UPS will alarm when related events occur.
- All Mute: When “enable” is selected, all the faults and warnings will be mute. It will show icon on the top right corner of the main screen.
- Mode Mute: UPS status mode alarm enable/disable. If “Mode Mute” is activated, it will show icon on the top right corner of the main screen.
- Energy Star: Enable and Disable can be done only in Line mode and ECO mode.
  - Enable: UPS will transfer between line mode and eco mode as needed
  - Disable: UPS will remain in programmed mode. Disable is the default setting.

## ADVANCE

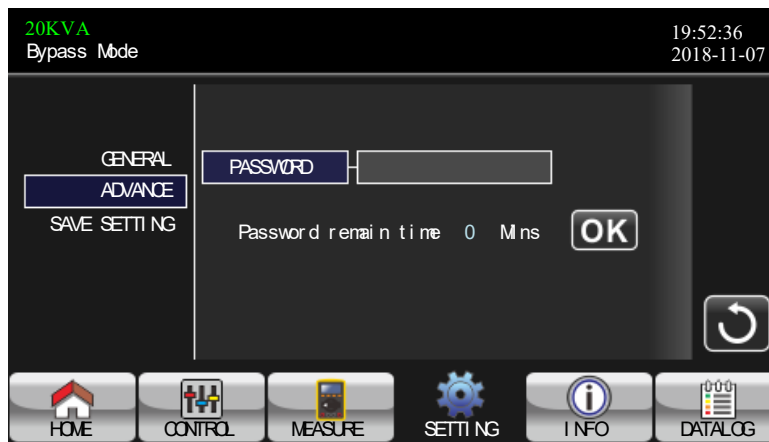

Advance Password Page

It's required to enter password (4 digits) to access to the “ADVANCE” page.

>ADVANCE > User

To access to the “Advance>User” Setting menu page, the default password is “0000”.

If entered password is right, the page will jump to setting screen. If the password is wrong, it will ask to enter again.



Password error page



Advance Setting Menu Page

There are three sub-menus under “Advance>User” setting: ELECTRONIC, BATTERY and MISCELLANEOUS.

## ELECTRICAL



Electrical Setting Page 1

### Electrical Setting Page 1

- Output Voltage: Select the output rated voltage.
- There are two options, 120V and 127V. 120Vac is default setting.
- Output Frequency: Select output rated frequency.
- 50Hz: The output frequency is setting for 50Hz.
- 60Hz: The output frequency is setting for 60Hz. 60Hz is the default setting.
- CVCF Mode (constant voltage and constant frequency function)
  - Enable:** CVCF function is enabled. The output frequency will be fixed at 50Hz or 60Hz according to setting of “OP Freq.”. The input frequency could be from 40Hz to 70Hz.
  - Disable:** CVCF function is disabled. The output frequency will synchronize with the bypass frequency within 45~55 Hz for 50Hz system or within 55~65 Hz for 60Hz system. Disable is the default setting.
- Bypass Forbid:
  - Enable:** Bypass forbid is enabled. When selected, it's not allowed for running in Bypass mode under any situations.
  - Disable:** Bypass forbid is disabled. When selected, UPS will run in Bypass mode depending on “Bypass at UPS off” setting. It is the default setting.

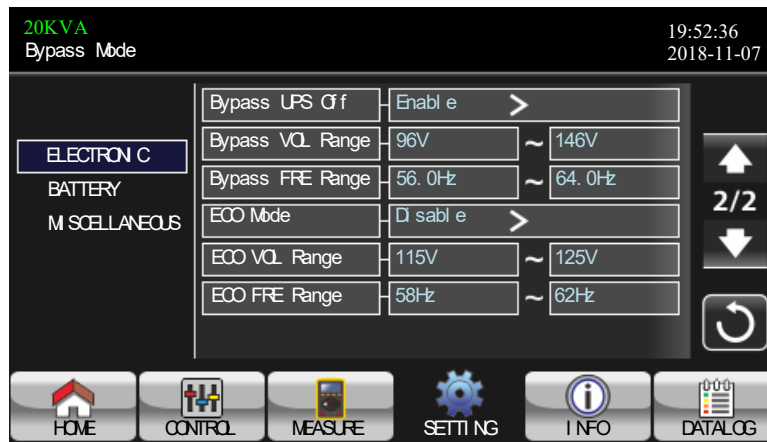

Electrical Setting Page 2

- Bypass at UPS off: Select the bypass status when manually turning off the UPS. This setting is only available when “Bypass forbid.” is set to “Disable”.  
**Enable:** Bypass enabled. When selected, bypass mode is activated. Enable is the default setting.  
**Disable:** Bypass disabled. When selected, no output through bypass when manually turning off the UPS.
- Bypass Voltage Range: Set the bypass voltage range.  
L: Low voltage point for bypass. The setting range is 96V ~ 110V. 96V is default setting.  
H: High voltage point for bypass. The setting range is 130V ~ 146V. 146V is default setting.
- Bypass FRE Range: Set the bypass frequency range.
- The acceptable bypass frequency range from 46Hz to 54Hz when UPS is 50Hz system and from 56Hz to 64Hz when UPS is 60Hz system. 56Hz to 64Hz is the default setting.
- ECO mode: Enable/Disable ECO mode. Disable is the default setting.
- ECO Voltage Range: Set the ECO voltage range.  
L: Low voltage point for ECO mode. The setting range is from “Rated output voltage – 5V” to “Rated output voltage - 11V”. “Rated output voltage – 5V” is default setting.  
H: High voltage point for ECO mode. The setting range is from “Rated output voltage + 5V” to “Rated output voltage + 11V”. “Rated output voltage + 5V” is default setting.
- ECO FRE Range: Set the ECO frequency range. The setting range is from 46Hz to 54Hz when the UPS is 50Hz system and from 56Hz to 64Hz when the UPS is 60Hz system. 56Hz to 64Hz is the default setting.

## BATTERY

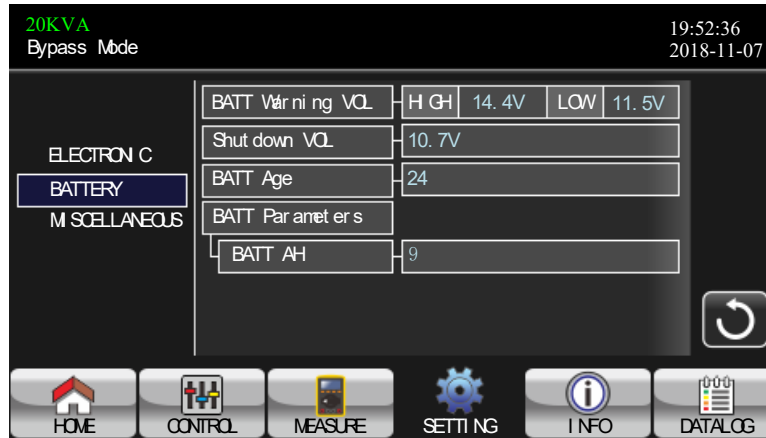

Battery setting page

- **Battery Warning Voltage:**  
 HIGH: High battery warning voltage. The setting range is 14.0V ~ 15.0V. 14.4V is default setting.  
 LOW: Low battery warning voltage. The setting range is 10.1V ~ 14.0V. 11.4V is default setting. This parameter setting is related to “Shutdown Voltage” setting. This setting value should be higher than “Shutdown Voltage” setting.
- **Shutdown Voltage:** If battery voltage is lower than this point in battery mode, UPS will automatically shut down. The setting range is 10.0V ~ 12.0V. 10.7V is default setting. (The setting is only available for long-run model)
- **Battery Parameter:**  
 Battery AH: setting battery capacity. Range is 7 – 200. 9Ah is default setting.

## MISCELLANEOUS

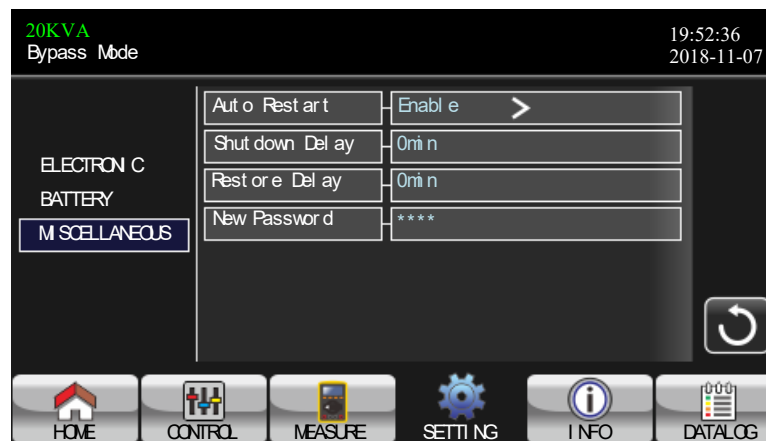

Miscellaneous setting page

- **Shutdown Delay Min:** UPS will shut down in setting minutes. The countdown will start after confirming the pop-up screen.
- **Restore Delay Min:** UPS will automatically restart in setting minutes after the UPS shuts down.
- **New Password:** Set up new password to enter “ADVANCE> User” menu.

## ADVANCE &gt; Maintainer



Advance: Maintainer Setting Menu Page1

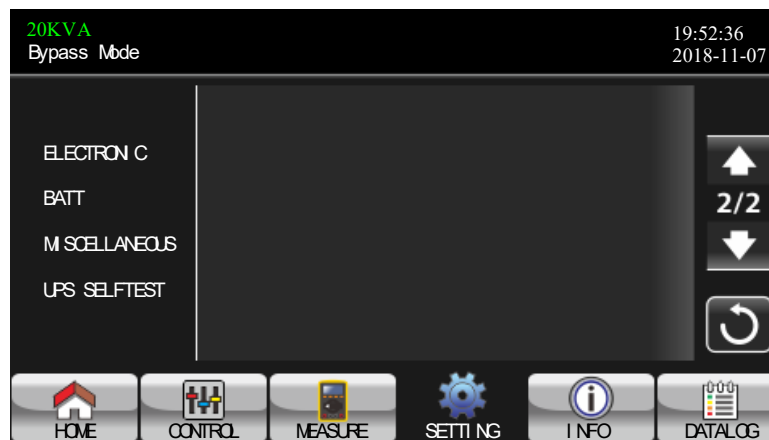

Advance: Maintainer Setting Menu Page2

To access the “Advance>Maintainer” Setting menu page, it’s required to enter password. Please contact your local dealer to get maintainer password.

**CAUTION:** This setting menu is only for qualified technician. Otherwise, mis-operation will cause UPS damage.

There are nine sub-menus under “Advance>Maintainer” setting: SYS PARAMETER, INSTALL INFO, VOL CALI, CURR CALI, INITIAL, ELECTRONIC, BATT, MISCELLANEOUS and UPS SELFTEST.

## SYS PARAMETER



SYS Parameter Page1

- Mode Name: Set the UPS model name.
- Serial Number: Set the serial number.
- Manufacturer: Set the UPS manufacturer.
- Charger Number: The number of charging boards installed in the UPS.

NOTE: It's required to restart the UPS after setting. The setting for 15K to 40K only.

One charger board: When selected, there are four options available for "Max Charge CURR".

Two charger boards: When selected, there are two options available for "Max Charge CURR".

Three charger boards: When selected, there are three options available for "Max Charge CURR".

- Max Charge CURR: The maximum of battery charging current. This parameter setting is related to "Charger Number" setting.

If UPS is 15K or 20K, the selectable charge current is listed below.

One charger board: There are four options, 1A, 2A, 3A, 4A. 4A is default setting.

Two charger boards: There are two options, 4A and 8A. 4A is default setting.

Three charger boards: There are three options, 4A, 8A, 12A. 4A is default setting.

Four charger boards: There are four options, 4A, 8A, 12A, 16A. 4A is default setting. (Only for 15K and 20K)

Five charger boards: There are five options, 4A, 8A, 12A, 16A, 20A. 4A is default setting. (Only 15K and 20K)

If UPS is 30K or 40K, the selectable charge current is listed below.

- One pairs of charger boards: There are four options, 2A, 4A, 6A, 8A. 8A is default setting.
- Two pairs of charger boards: There are two options, 8A, 16A. 8A is default setting.
- Three pairs of charger boards: There are three options, 8A, 16A, 24A. 8A is default setting.

If UPS is 10K, it only has a charging board.

- The charging current is from 1A to 12A. 4A is default setting.
- BATT Number: The total number of installed battery. (UPS should be restarted after setting.) The setting range is 8 ~ 10. 10 is default setting.
- Float VOL: The setting point of battery float voltage. 13.6V is default setting.
- UPS Type: There are two options, HV and LV. This change is only allowed for qualified technician.  
NOTE: It's required to restart the UPS after setting.

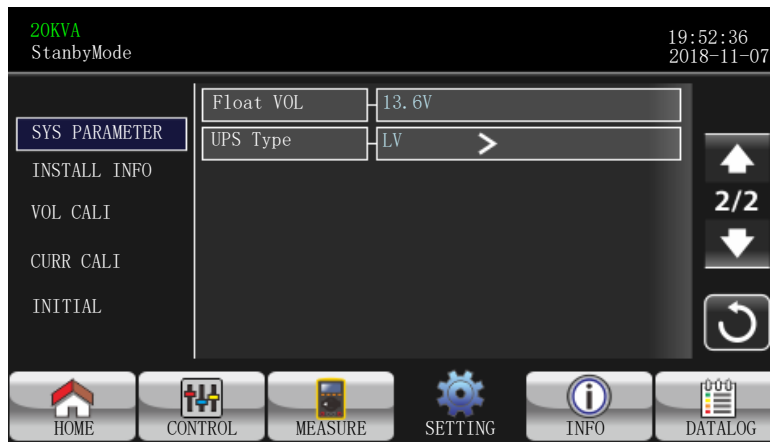

SYS Parameter Page 2

**INSTALL INFO**

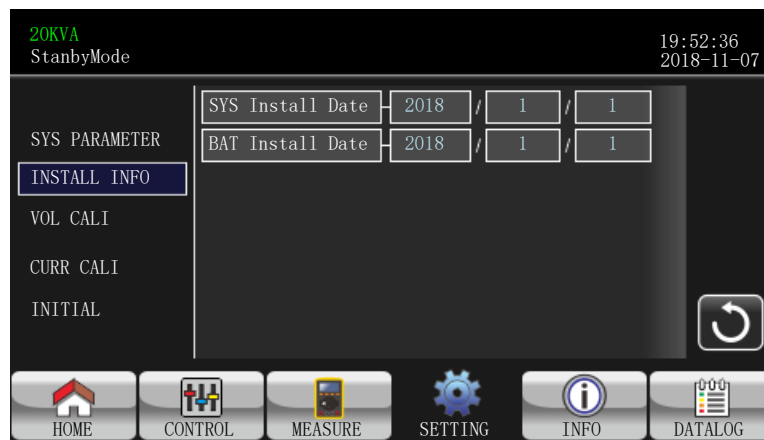

Install info Page

SYS Install Date: Set the date of UPS installation.  
 BAT Install Date: Set the date of Battery installation.

**VOL CALI**

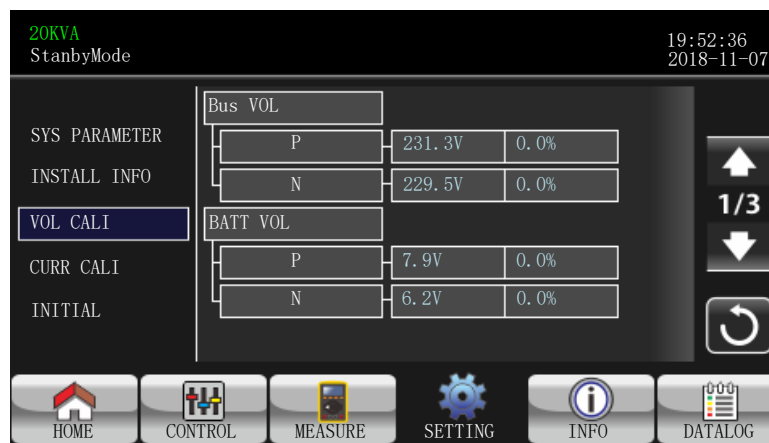





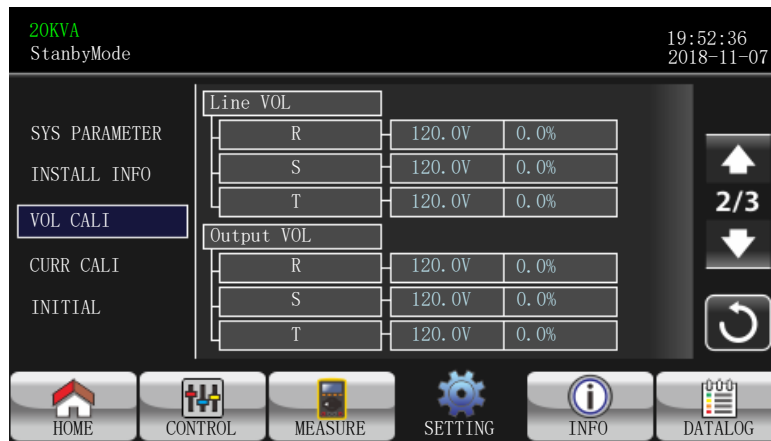

Voltage Calibration Page1

- Bus VOL: BUS voltage calibration. Each click is 0.1% no matter it's pressing up or down key . Press "up" key to increase 0.1% and press "down" key to decrease 0.1%. Press "OK" key to confirm the modification.
- BATT VOL: Battery voltage calibration. Each click is 0.1% no matter it's pressing up or down key . Press "up" key to increase 0.1% and press "down" key to decrease 0.1%. Press "OK" key to confirm the modification



Voltage Calibration Page2

- Line VOL: Line voltage calibration. Each click is 0.1% no matter it's pressing up or down key    . Press "up" key to increase 0.1% and press "down" key to decrease 0.1%. Press "OK" key to confirm the modification.
- Output VOL: Output voltage calibration. Each click is 0.1% no matter it's pressing up or down key    . Press "up" key to increase 0.1% and press "down" key to decrease 0.1%. Press "OK" key to confirm the modification.

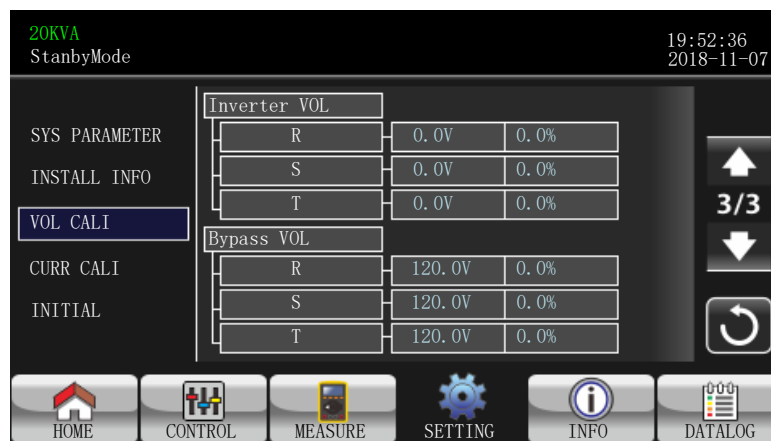

Voltage Calibration Page3

- Inverter VOL: Inverter voltage calibration. Each click is 0.1% no matter it's pressing up or down key . Press "up" key to increase 0.1% and press "down" key to decrease 0.1%. Press "OK" key to confirm the modification.
- Bypass VOL: Bypass voltage calibration. Each click is 0.1% no matter it's pressing up or down key . Press "up" key to increase 0.1% and press "down" key to decrease 0.1%. Press "OK" key to confirm the modification.



**CURR CALI**

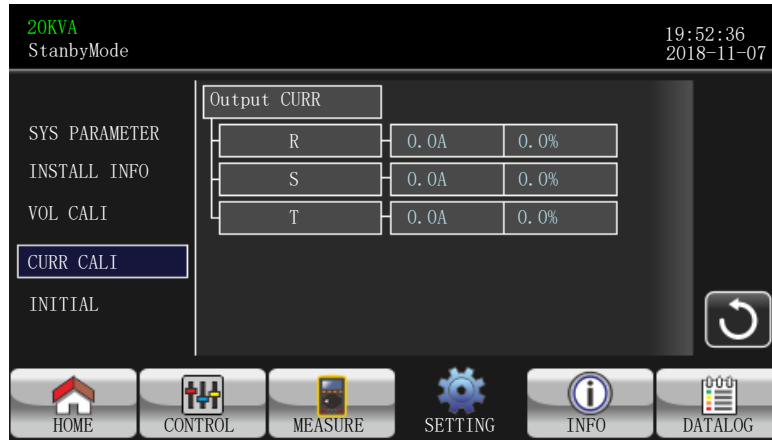

Current Calibration Page

- Output CURR: Output current calibration. Each click is 0.1% no matter it's pressing up or down key . Press "up" key to increase 0.1% and press "down" key to decrease 0.1%. Press "OK" key to confirm the modification.

**INITIAL**

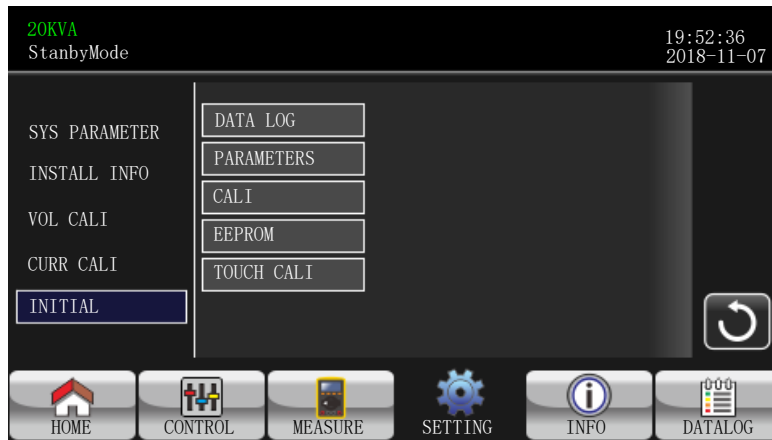

INITIAL menu Page

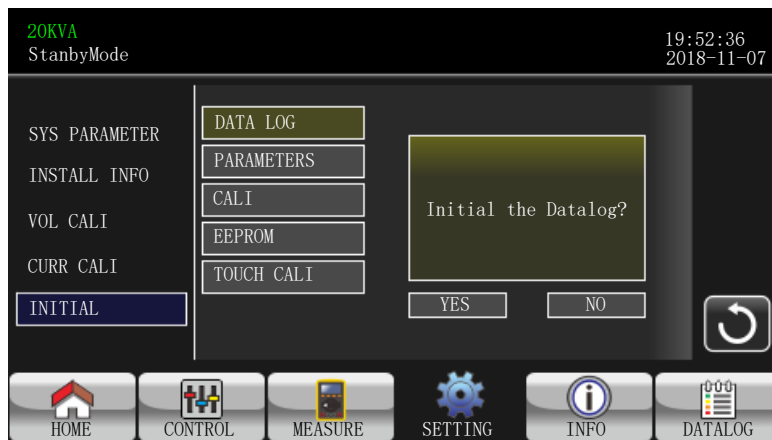

Initial Dialog Page

- DATA LOG: After pressing, the confirmation window, it will pop up as shown in above screen. Touch "YES" to clear the DATALOG page. Touch "Back" or "No" to cancel this operation and back to INITIAL menu page



INITIAL PARAMETERS Page

- PARAMETERS: After pressing the confirmation window, it will pop up as shown in above screen. Touch "YES" to restore default value. Touch "Back" or "No" to cancel this operation and back to INITIAL menu page.

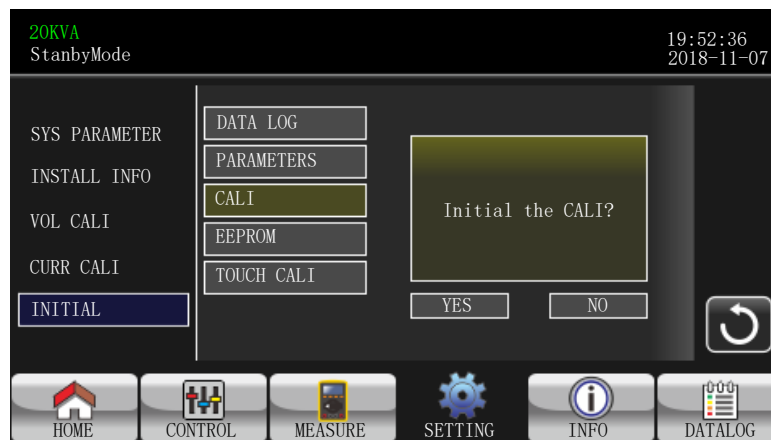

INITIAL CALI Page

- CALI: After pressing the confirmation window, it will pop up as shown in above screen. Touch "YES" to restore default calibration value. Touch "Back" or "No" to cancel this operation and back to INITIAL menu page.

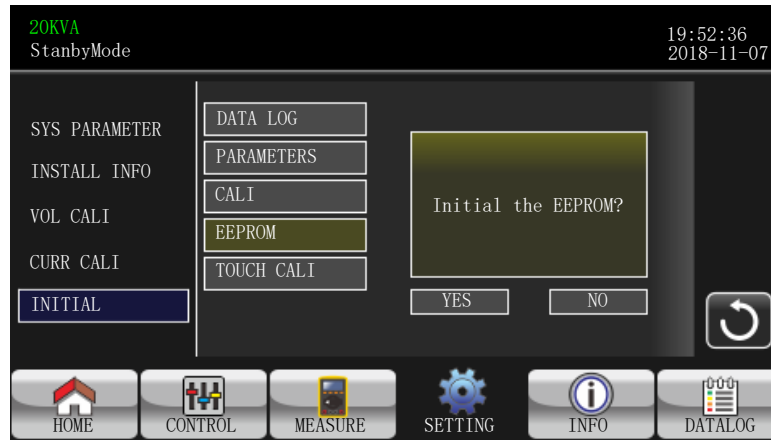

Initial EEPROM Page

- EEPROM: After pressing the confirmation window, it will pop up as shown in above screen. Touch “YES” to clear all setting value in EEPROM. Touch “Back” or “No” to cancel this operation and back to INITIAL menu page.



Initial Touch PAGE

- TOUCH CALI: After pressing the confirmation window, it will pop up as shown in above screen. Touch screen to recalibrate. Then, the blue screen appears and please click on the place of the cross with your mouse.

**ELECTRICAL**



Electrical Setting Page 1

- Output Voltage: Select the output rated voltage.  
There are two options, 120V and 127V. 120Vac is default setting.
- Output Rated FRE: Select output rated frequency.  
50Hz: The output frequency is setting for 50Hz.  
60Hz: The output frequency is setting for 60Hz. 60Hz is the default setting.
- VCF Mode (constant voltage and constant frequency function)  
Enable: CVCF function is enabled. The output frequency will be fixed at 50Hz or 60Hz according to setting of "Output Freq.". The input frequency could be from 40Hz to 70Hz.  
Disable: CVCF function is disabled. The output frequency will synchronize with the bypass frequency within 45~55 Hz for 50Hz system or within 55~65 Hz for 60Hz system. Disable is the default setting.
- Bypass Forbid:  
Enable: Bypass Forbid is enabled. It's not allowed for running in Bypass mode under any situations.  
Disable: Bypass Forbid is disabled. UPS will run in Bypass mode. It is the default setting.

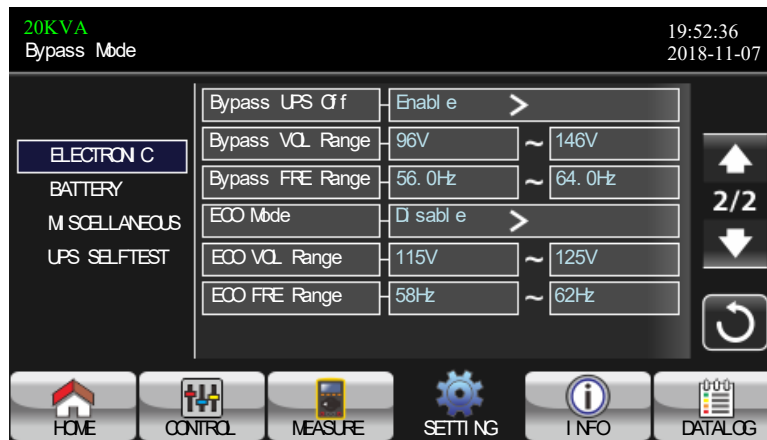

Electrical Setting Page 2

- Bypass at UPS off: Select the bypass status when manually turning off the UPS. This setting is only available when "Bypass forbid" is set to "Disable".  
Enable: Bypass enabled. When selected, bypass mode is activated. Enable is the default setting.  
Disable: Bypass disabled. When selected, no output through bypass when manually turning off the UPS.
- Bypass Voltage Range: Set the bypass voltage range.  
L: Low voltage point for bypass. The setting range is 96V ~ 110V. 96V is default setting.  
H: High voltage point for bypass. The setting range is 130V ~ 146V. 146V is default setting.
- Bypass FRE Range: Set the bypass frequency range.  
The acceptable bypass frequency range from 46Hz to 54Hz when UPS is 50Hz system and from 56Hz to 64Hz when UPS is 60Hz system.
- ECO mode: Enable/Disable ECO mode. Default setting is "Disable".
- ECO Voltage Range: Set the ECO voltage range.  
L: Low voltage point for ECO mode. The setting range is from "Rated output voltage - 5V" to "Rated output voltage - 11V". "Rated output voltage - 5V" is default setting.  
H: High voltage point for ECO mode. The setting range is from "Rated output voltage + 5V" to "Rated output voltage + 11V". "Rated output voltage + 5V" is default setting.
- ECO FRE Range: Set the ECO frequency range. The setting range is from 48Hz to 52Hz when the UPS is 50Hz system and from 58Hz to 62Hz when the UPS is 60Hz system.

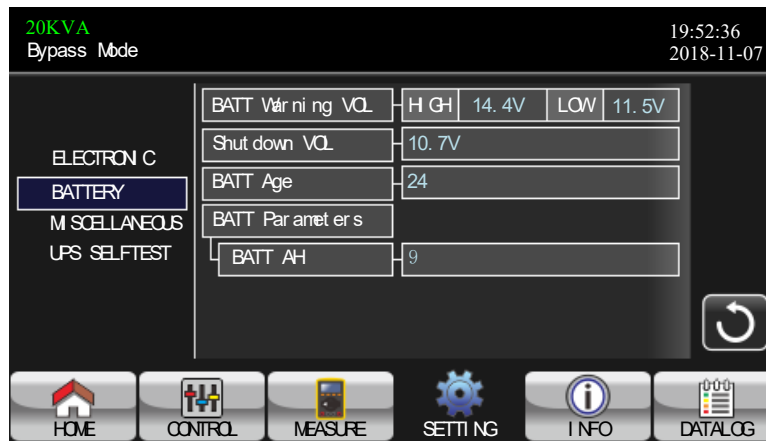
**BATTERY**

Battery Setting Page

- **Battery Warning Voltage:**  
 HIGH: High battery warning voltage. The setting range is 14.0V ~ 15.0V. 14.4V is default setting.  
 LOW: Low battery warning voltage. The setting range is 10.1V ~ 14.0V. 11.4V is default setting. This parameter setting is related to “Shutdown Voltage” setting. The setting value should be higher than “Shutdown Voltage” setting.
- **Shutdown Voltage:** If battery voltage is lower than this point in battery mode, UPS will automatically shut down. The setting range is 10.0V ~ 12.0V. 10.7V is default setting (The setting is only available for long-run model)
- **Battery Parameter:**
- **Battery AH:** setting battery capacity. 9Ah is default setting.

**MISCELLANEOUS**

Miscellaneous setting page

- **Shutdown Delay Min:** UPS will shut down in setting minutes. The countdown will start after confirming the pop-up screen.
- **Restore Delay Min:** UPS will automatically restart in setting minutes after the UPS shuts down.
- **New Password:** Set up User new password to enter “ADVANCE User” menu page.
- **DefaultUserPassword:**  
 YES: After “YES” is set, User password will restore default setting value.  
 NO: After “NO” is set, the UPS will cancel this operation.



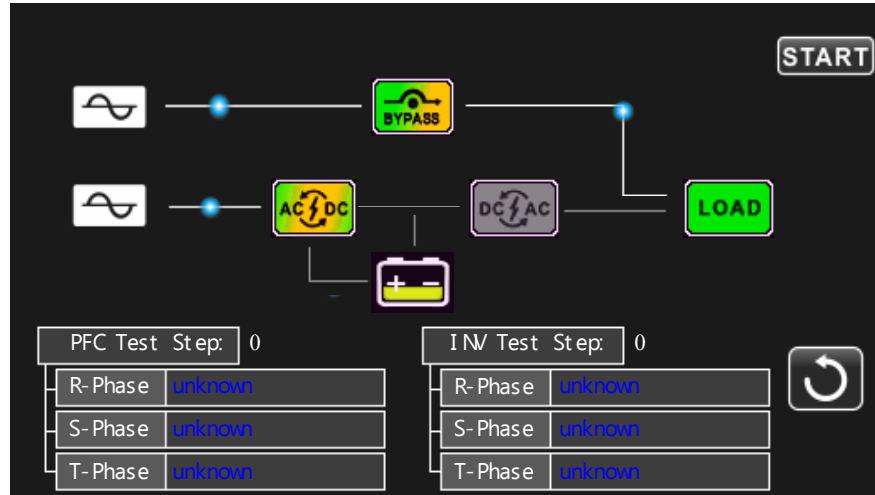

**UPS SELFTEST**



This function is only effective when UPS type setting is “HV”. Therefore, please disconnect all loads and utility first before executing this function. Then, please change UPS type to “HV”. For the detailed operation, please check “System Parameter” menu under Advance> Maintainer directory.

After changing UPS type to “HV”, you have to restart the UPS. After the UPS is restarted, please enter Advance screen and enter Maintainer password. It will show “UPS SELFTEST” selection in the screen. In the screen, all tested items are shown “unknown”. Simply click “UPS SELFTEST” button, the UPS will start self-test. If the UPS is normal, it will show “Normal” in all columns. Otherwise, “Unknown” will be displayed in the columns.

**3-3-5. Information screen**

Touch the icon  to enter information page. Touch the icon  or  to browse information. Touch the icon  to return to main screen. Touch the icon  to go back to previous menu.



Basic Information Page

## Basic Information Page

### Basic Information

- MCU Version: MCU version.
- DSP Version: DSP version.
- Serial NO.: The serial number of UPS.
- Manufacturer: The information about manufacturer.
- Service Contact: The contact name is set in “Basic Setting”.
- Service Phone: The listed numbers are set in “Basic Setting”.
- Service Mail: The service email account is set in “Basic Setting”.

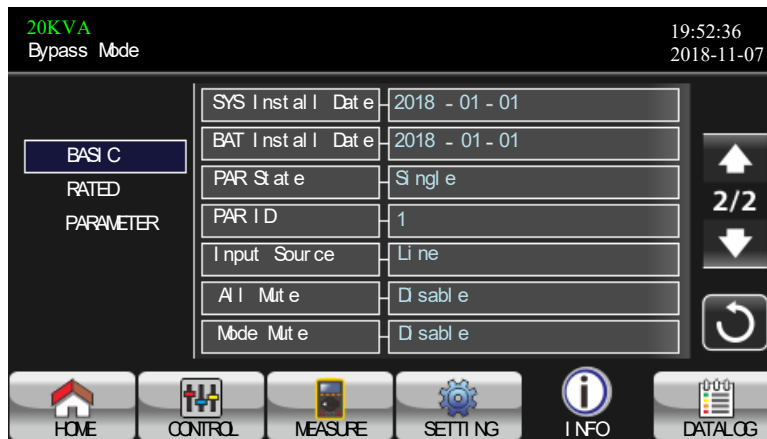

Basic Information Page2

- SYS Install Date: The date of system installation.
- BAT Install Date: The date of battery installation.
- PAR State: The information of parallel state.
- PAR ID: The UPS ID number in parallel state.
- Input Source: The information of input source.
- All Mute: Enable/disable all mute function.
  - Mode Mute: Enable/disable mode mute function.



Rated Information Page

## Rated Information

- Output Voltage: It shows output rated voltage.
- Output FRE: It shows output rated frequency.
- CVCF Mode: Enable/Disable CVCF mode.
- Bypass Forbid: Enable/disable bypass function.
- Bypass UPS Off: Enable/disable auto bypass function when UPS is off.
- Auto Restart: Enable/disable auto-restart function.
  - ECO Mode: Enable/disable ECO function.

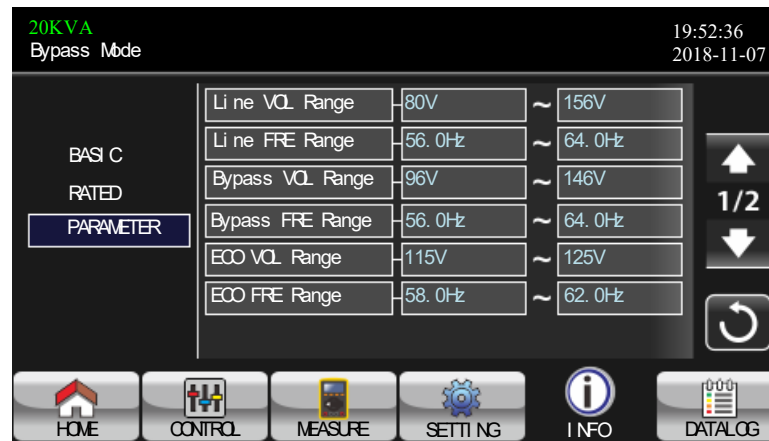

Parameter Information Page 1

## Parameter Information

- Line Voltage Range: The acceptable line input voltage range.
- Line FRE Range: The acceptable line input frequency range.
- Bypass Voltage Range: The acceptable input voltage range for bypass mode.
- Bypass FRE Range: The acceptable input frequency range for bypass mode.
- ECO Voltage Range: The acceptable input voltage range for ECO mode.
- ECO FRE Range: The acceptable input frequency range for ECO mode.

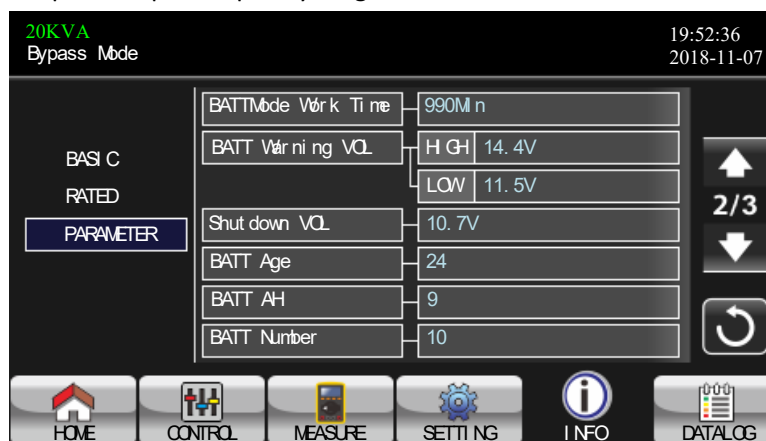

Parameter Information Page 2







- BATT Mode Work Time: The maximum discharge time in battery mode.
- BATT Warning Voltage:  
HIGH: High battery warning voltage.  
LOW: Low battery warning voltage.
- Shutdown Voltage: If battery voltage is lower this point, UPS will automatically shut down.
- Battery Age: Battery Age Alarm setting is displayed.
- Battery AH: Battery AH setting is displayed.
- Battery Number: Battery number is displayed.



Parameter Information Page 3

- Charger Number: The information of charger number.
- Max Charge CURR: The setting value of the maximum charging current.
- Float VOL: The setting value of the battery float voltage.
- UPS Type: The information of UPS type.
- Shutdown Delay: UPS will shut down in setting minutes. The countdown will start after confirming the pop-up screen.
- Restore Delay: UPS will automatically restart in setting minutes after the UPS shuts down.

### 3-3-6. Data Log screen

Touch the icon  to enter date log page. Data log is used to record the warning and fault information of the UPS. The record contains date & time, code, type and description. Touch the icon  or  to page up or down if there are more than one page in the date log. Touch the icon  to return to main screen. Press the icon  to go back to main menu. Please refer to Section 3-7 and 3-8 for warning and fault code list.

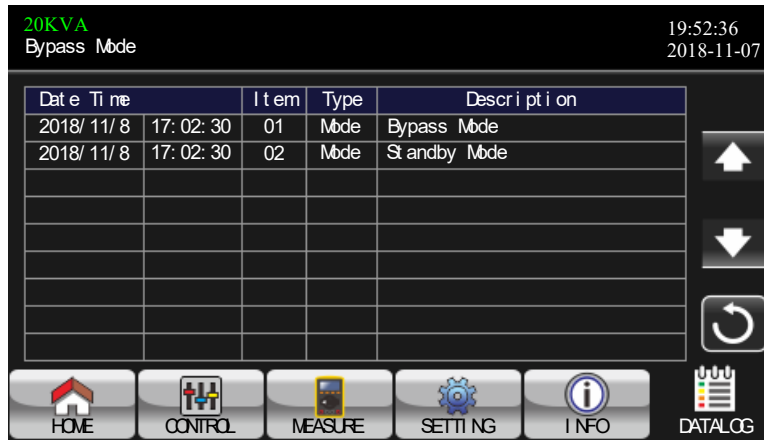

Data Log Page

### 3-4. Audible Alarm

Description	Buzzer status	Muted
UPS status		
Bypass mode	Beeping once every 2 minutes	Yes
Battery mode	Beeping once every 4 seconds	
Fault mode	Beeping continuously	
Warning		
Overload	Beeping twice every second	Yes
Others	Beeping once every second	
Fault		
All	Beeping continuously	Yes

### 3-5. Single UPS Operation

#### 1. Turn on the UPS with utility power (in AC mode)

1) After power mains is connected correctly, set the breaker of the battery pack to “ON” position (this step only necessary for long-run model). Then set the line input breaker to “ON” position. At the same time the fan will start running and the UPS will start initialization. In just a few seconds, the UPS will supply power to the loads via the Bypass mode.

NOTE: When UPS is in Bypass mode, the output voltage will be directed from mains after you switch on the input breaker. In Bypass mode, the load is not protected by the UPS. To protect your precious devices, you should turn on the UPS. Refer to next step.

2) Touch “CONTROL” and select “UPS on/off” icon. It will show “Turn on UPS?” in screen and select “Yes”. Refer to On/Off UPS screen. Or press the power button.

3) In just a few seconds, the UPS will enter into AC mode. If the mains is abnormal, the UPS will operate in Battery mode without interruption.

NOTE: When the UPS runs out battery, it will shut down automatically in Battery mode. When the mains is normalized, the UPS will auto restart in AC mode.

## 2. Turn on the UPS without utility power supply (in Battery mode)

- 1) Make sure that the two strings of batteries are connected correctly in order of "+,GND,-" terminals and the breaker of the battery pack is at "ON" position (only for long-run model).
- 2) Press the " " button to set up the power supply for the UPS. UPS will enter to power on mode. After initialization, UPS will enter to "No Output mode".
- 3) In just a few seconds, the UPS will be turned on and enter into Battery mode.

## 3. Connect devices to UPS

After the UPS is turned on, you can connect devices to the UPS.

- 1) Turn on the UPS first and then switch on the devices one by one. The LCD panel will display total load level.
- 2) If it is necessary to connect the inductive loads such as a printer, the in-rush current of the load should be calculated carefully to see if it meets the overload capability of the UPS. Any load more than 150% over designed capacity the runtime will be less than 60ms
- 3) If the UPS is overload, the buzzer will beep twice every second.
- 4) When the UPS is overload, please remove some loads immediately. It is recommended to have the total loads connected to the UPS less than 80% of its nominal power capacity to prevent overload for system safety.
- 5) If the overload time is over acceptable time listed in spec in AC mode, the UPS will automatically transfer to Bypass mode. After the overloading was resolved, it will return back to AC mode. If the overload time is over acceptable time listed in spec in Battery mode, the UPS will enter fault status. At this time, if bypass is enabled, the UPS will power to the load via bypass. If bypass function is disabled or the input power is not within bypass acceptable range, it will cut off output entirely.

## 4. Charge the batteries

- 1) After the UPS is connected to the mains and turned on in AC mode, the charger will charge the batteries automatically except in battery mode, during battery self-test, overload or when battery voltage is high.
- 2) It's recommended to charge batteries for at least 10 hours before operation. Otherwise, the backup time may be shorter than expected.

## 5. Battery mode operation

- 1) When the UPS is in Battery mode, the buzzer will sound according to different battery capacity. If the battery capacity is more than 25%, the buzzer will beep once every 4 seconds. If the battery voltage drops to the alarm level, the buzzer will beep once every sec to remind users that the battery is at low level and the UPS will shut down imminently. Users could switch off some non-critical loads to disable the shutdown alarm and prolong the backup time. If there is no more load to be switched off, you have to prepare shutdown procedure to preserve working data or devices. Otherwise, there is a risk of data loss or load failure.
- 2) In Battery mode, users can touch "SETTING" > "Basic" > Audio Mute to enable "Mode Mute" to disable the buzzer.
- 3) The backup time of the long-run model depends on the external battery capacity.
- 4) The backup time may vary from different operating temperature and load type.

## 6. Test the batteries

- 1) If you need to check the battery status when the UPS is running in AC mode/CVCF mode, you could touch "CONTROL" and select "Battery Test". Refer to "Battery Test" screen.
- 2) Users also can set battery self-test through monitoring software.

**7. Turn off the UPS with utility power supply in AC mode**

1) Touch "CONTROL" and select "Turn off UPS" icon to turn off the UPS. Refer to "UPS on/off" screen.

NOTE 1: If the UPS has been set to bypass output, it will bypass voltage from the mains to output terminal even though you have turned off the UPS (inverter).

NOTE 2: After turning off the UPS, please be aware that the UPS is working in Bypass mode, there will be risk of power loss for connected devices.

2) In Bypass mode, output voltage of the UPS is still present. In order to cut off the output, switch off the line input breaker. The LCD display will turn off and UPS is now completely off.

**8. Turn off the UPS without utility power supply in Battery mode**

1) Touch "CONTROL" and select "Turn off UPS" icon to turn off the UPS. Refer to "UPS on/off" screen.

2) Then UPS will cut off power to output terminals.

**9. Mute the buzzer**

1) Touch "SETTING" and select "BASIC" item. There are two events available to mute. Refer to "SETTING" screen.

2) Some warning alarms can't be muted unless the error is fixed. Please refer to section 3-4 for details.

**10. Operation in warning status**

1) When LCD screen shows "Fault Mode" and the buzzer beeps once every second, it indicates that there are problems for UPS operation. Users can read the warning message(s) from "DATA LOG" menu. Please refer to the Section 3-3-6 for details.

2) Some warning alarms can't be muted unless the error is fixed. Please refer to section 3-4 for details.

**11. Operation in Fault mode**

1) When the buzzer beeps continuously, it means that there is a fatal error with the UPS. Users can get the fault code from "DATA LOG" menu. Please refer to the Section 3-3-6 for details.

2) Please check the loads, wiring, ventilation, mains, battery and so on after the fault occurs. Don't try to turn on the UPS again before solving the issues. If the problems persist, contact the distributor or service personnel immediately.

3) In case of an emergency, shut off connections from mains, external battery, and output immediately to avoid possible damage to the UPS or equipment.

**12. Operation in maintenance mode**

This operation should only be performed by maintenance personnel or qualified technicians.

When the UPS needs repair or service and the load could not be shut off, the UPS needs to be put into maintenance mode.

1) First, turn off UPS from the touch panel or press the power button.

2) Then, remove the cover of maintenance bypass switch on the panel.

3) Turn the maintenance switch to "BPS" position.

### 3-6. Parallel Operation

#### 1. Parallel system initial startup

Please make sure that all of the running UPSs are parallel models and have the same configuration.

- 1) Turn on each UPS in AC mode respectively (Refer to section 3-5(1)). Then, measure the inverter output voltage of each phase for each UPS with a multi-meter. Calibrate the inverter output voltage by configuring inverter voltage adjustment (Refer to SETTING VOL CALI screen) in LCD menu until the inverter output voltage difference of each UPS is within 1V or less.
- 2) Turn off each UPS (Refer to section 3-5(7.)). Then, follow the wiring procedure in section 2-5.
- 3) Remove the cover of parallel share current cable port on the UPS, connect each UPS one by one with the parallel cable and share current cable, and then replace the cover.
- 4) Turn on the parallel system in AC mode:
  - a) Turn on the line input breaker of each UPS. If using dual-input unit, please also turn on the external bypass input breaker. After all UPSs enter into bypass mode, measure the output voltage between two UPSs for the same phase to make sure the phase sequence is correct. If these two voltage differences are near to zero, that means all connections are met. Otherwise, please check if the wirings are connected correctly.
  - b) Turn on the output breaker of each UPS.
  - c) Turn on each UPS in turns. After a while, the UPSs should enter into AC mode synchronously and then, the parallel system is now complete.
- 5) Turn on the parallel system in Battery mode:
  - a) Turn on the battery breaker (only available in long-run model) and external output breaker of each UPS.
  - b) Turn on any UPS. A few seconds later, the UPS will enter into battery mode.
  - c) Turn on the next UPS in sequence until all the UPSs enter into Battery mode and add to the parallel system. Now the parallel system is now complete.

If you would like to have more information regarding the parallel operation, please contact your supplier or service center for detail parallel operation instruction.

#### 2. Add new units into the parallel system

- 1) You can not add new unit into the parallel system when whole system is running. You must cut off the load and shut down the system.
- 2) Make sure all of the UPS are the parallel models, and follow the wiring reference in section 2-5.
- 3) Install the new parallel system as per section 2-6.

### 3. Remove units from the parallel system

There are two methods to remove units from the parallel system:

First method:

- 1) Touch "CONTROL" > "Turn off UPS" and select "Yes" to turn off the UPS. Then, the UPS will enter into Bypass mode or No Output mode without output.
- 2) Turn off the external output breaker of this unit, and then turn off the input breaker of this unit.
- 3) Turn off the battery breaker(only available in long-run model) and remove the parallel and share current cables. And then remove the unit from the parallel system.

#### **Second method:**

- 1) If the bypass is abnormal, you can not remove the UPS without interruption. You must cut off the load and shut down the system.
- 2) Make sure the bypass setting is enabled in each UPS and then turn off the system. All UPSs will transfer to Bypass mode. Remove all the maintenance bypass covers and set the maintenance switches from "UPS" to "BPS" position. Turn off all the input breakers and battery breakers in parallel system.
- 3) Turn off the output breaker and remove the parallel cable and share current cable of the UPS which you want to remove. Now, you can remove the UPS from parallel system.
- 4) Turn on the input breaker of the remaining UPS and the system will transfer to Bypass mode. Set the maintenance switches from "BPS" to "UPS" position and put the maintenance bypass covers back on.
- 5) Turn on the remaining UPS according to the previous section.

Warning: (Only for the parallel system)

- Before turning on the parallel system to activate inverter, make sure that all unit's maintenance switch at the same position.
- When parallel system is turned on, please do not operate the maintenance switch of any unit.
- The parallel system DOES NOT support ECO mode. Therefore, please DO NOT "enable" ECO mode in any unit.

### 3-7. Fault Code

Fault code	Fault event	Icon	Fault code	Fault event	Icon
01	Bus start failure	None	47	MCU communication failure	None
02	Bus over	None	48	Two DSP firmware versions are incompatible in parallel system.	None
03	Bus under	None	49	Input and output phase are incompatible	None
04	Bus unbalance	None	60	Bypass phase short circuited	None
06	Converter over current	None	61	Bypass SCR short circuited	
11	Inverter soft start failure	None	62	Bypass SCR open circuited	None
12	High inverter voltage	None	63	Voltage waveform abnormal in R phase	None
14	Inverter R output(line to neutral) short circuited		64	Voltage waveform abnormal in S phase	None
15	Inverter S output(line to neutral) short circuited	None	65	Voltage waveform abnormal in T phase	None
16	Inverter T output(line to neutral) short circuited	None	66	Inverter current sample abnormal	None
17	Inverter R-S output (line to line) short circuited	None	67	Bypass O/P short circuited	None
18	Inverter S-T output (line to line) short circuited	None	68	Bypass O/P line to line short circuited	None
19	Inverter T-R output (line to line) short circuited	None	69	Inverter SCR short circuited	None
1A	Inverter R negative power fault	None	6C	BUS voltage drops too fast	None
1B	Inverter S negative power fault	None	6D	Current sampling error value	None
1C	Inverter T negative power fault	None	6E	SPS power error	None
21	Battery SCR short circuited	None	6F	Battery polarity reverse	None
23	Inverter relay open circuited	None	71	PFC IGBT over-current in R phase	None
24	Inverter relay short circuited	None	72	PFC IGBT over-current in S phase	None
25	Line wiring fault	None	73	PFC IGBT over-current in T phase	None
31	Parallel communication failure	None	74	INV IGBT over-current in R phase	None
36	Parallel output current unbalance	None	75	INV IGBT over-current in S phase	None
41	Over temperature	None	76	INV IGBT over-current in T phase	None
42	DSP communication failure	None	77	LCD & MCU communication failure	None
43	Over load	None			

### 3-8. Warning Code

Warning code	Warning event	Warning code	Warning event
01	Battery unconnected	21	Line situations are different in parallel system
02	IP Neutral loss	22	Bypass situations are different in parallel system
04	IP phase abnormal	33	Locked in bypass after overload 3 times in 30 minutes
05	Bypass phase abnormal	34	Converter current unbalanced
07	Over charge	3A	Cover of maintain switch is open
08	Low battery	3C	Utility extremely unbalanced
09	Overload	3D	Bypass is unstable
0A	Fan failure	3E	Battery voltage too high
0B	EPO enable	3F	Battery voltage unbalanced
0D	Over temperature	40	Charger short circuited
0E	Charger failure		



## 4. Trouble Shooting

Symptom	Possible cause	Remedy
No indication and alarm in the front display panel even though the mains is normal.	The AC input power is not connected well.	Check if input cable firmly connected to the mains.
The warning code 0B.	EPO function is activated. At this time, the EPO switch is in "OFF" status or the jumper is open.	Set the circuit in closed position to disable the EPO function.
The warning code 01.	The external or internal battery is incorrectly connected.	Check if all batteries are connected well.
The warning code 09.	UPS is overload.	Remove excess loads from UPS output.
	UPS is overloaded. Devices connected to the UPS are fed directly by the electrical network via the Bypass.	Remove excess loads from UPS output.
	After repetitive overloads, the UPS is locked in the Bypass mode. Connected devices are fed directly by the mains.	Remove excess loads from UPS output first. Then shut down the UPS and restart it.
Fault code is shown as 43.	UPS is overload too long and becomes fault. Then UPS shut down automatically.	Remove excess loads from UPS output and restart it.
Fault code is shown as 14, 15, 16, 17, 18 or 19,	The UPS shut down automatically because short circuit occurs on the UPS output.	Check output wiring and if connected devices are in short circuit status.
Other fault codes are shown on LCD display and alarm beeps continuously.	A UPS internal fault has occurred.	Contact your dealer
Battery backup time is shorter than nominal value.	Batteries are not fully charged.	Charge the batteries for at least 7 hours and then check capacity. If the problem still persists, consult your dealer.
	Batteries defect	Contact your dealer to replace the battery.
The warning code 0A.	Fan is locked or not working. Or the UPS temperature is too high.	Check fans and notify dealer.
The warning code 02.	The input neutral wire is disconnected.	Check and correct the input neutral connection. If the connection is ok and the warning is still displaying, please check input fuses of S and T.
	The S or T input fuse is broken.	Replace the fuse.

## 5. Storage and Maintenance

### 5-1. Storage

Before storing, charge the UPS at least 7 hours. Store the UPS covered and upright in a cool, dry location. During storage, recharge the battery in accordance with the following table:

Storage Temperature	Recharge Frequency	Charging Duration
-25°C - 40°C	Every 3 months	1-2 hours
40°C - 45°C	Every 2 months	1-2 hours

### 5-2. Maintenance



The UPS system operates with hazardous voltages. Repairs may be carried out only by qualified maintenance personnel.



Even after the unit is disconnected from the mains, components inside the UPS system are still connected to the battery packs which are potentially dangerous.

Before carrying out any kind of service and/or maintenance, disconnect the batteries and verify that no current is present and no hazardous voltage exists in the terminals of high capability capacitor such as BUS-capacitors.



Only persons who are adequately familiar with batteries and with the required precautionary measures may replace batteries and supervise operations. Unauthorized persons must be kept well away from the batteries.



Verify that no voltage between the battery terminals and the ground is present before maintenance or repair. In this product, the battery circuit is not isolated from the input voltage. Hazardous voltages may occur between the battery terminals and the grounding/earthing.



Batteries may cause electric shock and have a high short-circuit current. The following precautions should be observed when working on batteries:

- a) Remove watches, rings, or other metal objects.
- b) Use tools with insulated handles.
- c) Wear rubber gloves and boots.
- d) Do not lay tools or metal parts on top of batteries.
- e) Disconnect charging source prior to connecting or disconnecting battery terminals.
- f) Remove battery grounds during installation and maintenance to reduce likelihood of shock. Remove the connection from ground if any part of the battery is determined to be grounded.



When replace the batteries, install the same number and same type of batteries.



Do not attempt to dispose of batteries by burning them. This could cause battery explosion. The batteries must be deposited according to local environmental regulations.



Do not open or destroy batteries. Escaping electrolyte can cause injury to the skin and eyes. It may be toxic.



Please replace the fuse only with the same type and amperage in order to avoid fire hazards.



Do not disassemble the UPS system.

## Specifications

MODEL NUMBER		E91-10K	E91-15K	E91-20K	E91-30K	E91-40K
CAPACITY	Power rating	10kVA/10kW	15kVA/15kW	20kVA/20kW	30kVA/30kW	40kVA/40kW
INPUT	Voltage / Range	208Y/120VAC or 220Y/127VAC / 125-275VAC three-phase*				
	Frequency	46–54Hz or 56-64Hz				
OUTPUT	Voltage / Frequency	208/120VAC or 220/127VAC / 50/60±0.1%				
	Overload capacity	150% for 1 min, 125% for 10 min, 110% for 60 min				
	Efficiency	up to 94% online mode or 98% ECO mode				
INTERNAL BATTERY	Battery type	Sealed maintenance-lead acid				
	Battery quantity	40* 12V/9AH	60* 12V/9AH		60* 12V/580W	80* 12V/580W
	Max charging adjustable	4A			8A	
PHYSICAL	Dimensions (W x D x H)	9.9" x 26.3" x 32.3"	11.9" x 34" x 40.2"		23.6" x 31.1" x 65.4"	
	Weight	315 lbs	504 lbs	510 lbs	690 lbs	831 lbs
OPTIONAL BATTERY PACK	Model	EBP09-2 / EBP09-5			EBP10-5	
	Battery quantity and size	40* 12V 9AH / 100* 12V 9AH			100* 12V 580W	
	Weight	310 lbs / 670 lbs			770 lbs	
	Dimensions (W x D x H)	9.9" x 34"x 40.2" / 9.9" x 34"x 40.2"			9.4" x 34" x 40.2"	
ENVIRONMENT	Operating temperature	32–104°F (0–40°C)				
	Audible noise	<60dB for 10kVA; <65dB for 15/20/30/40				
	Altitude	5,200 ft above sea level**				
APPROVALS	UL, cUL, FCC					
WARRANTY	2 years warranty (USA and Canada)					
COMMUNICATIONS INTERFACE	RS-232, EPO, USB, intelligent slot for optional cards (Web/SNMP, Relay/dry contact)					
INCLUDED IN BOX	User manual, RS-232 communication cable, USB cable					
AVAILABLE OPTIONS	External maintenance bypass, output distribution, external battery cabinets					

\*Depending on load level \*\*Battery life is reduced above 30°C, UPS capacity derates above 40°C and 5,200 ft above sea level

## Obtaining Service

If the UPS requires Service:

1. Use the TROUBLESHOOTING section in this manual to eliminate obvious causes.
2. Verify there are no circuit breakers tripped.
3. Call your dealer for assistance. If you cannot reach your dealer, or if they cannot resolve the problem, call Xtreme Power Conversion Corp Technical Support at 800.582.4524. Technical support inquiries can also be made at [support@xpcc.com](mailto:support@xpcc.com). Please have the following information available BEFORE calling the Technical Support Department:
  - Your name and address.
  - The serial number of the unit.
  - Where and when the unit was purchased.
  - All of the model information about your UPS.
  - Any information on the failure, including LED's that may or may not be illuminated.
  - A description of the protected equipment, including model numbers if possible.
  - A technician will ask you for the above information and, if possible, help solve your problem over the phone. In the event that the unit requires factory service, the technician will issue you a Return Material Authorization number (RMA).

If you are returning the UPS to Xtreme Power for service, please follow these procedures:

1. Pack the UPS in its original packaging. If the original packaging is no longer available, ask the Technical Support Technician about obtaining a replacement set of packaging material. It is important to pack the UPS properly in order to avoid damage in transit. Never use Styrofoam beads for a packing material.
2. Include a letter with your name, address, daytime phone number, RMA number, a copy of your original sales receipt, and a brief description of the problem.
3. Mark the RMA number on the outside of all packages. Xtreme Power cannot accept any package without the RMA number marked on the outside of the boxes.
4. Return the UPS by insured, prepaid carrier to the address provided by the Technician.
5. Refer to the Warranty statements in this manual for additional details on what is covered.

## Xtreme Power Conversion E91 Limited Warranty

Xtreme Power Conversion (XPC) Corporation warrants Xtreme Power Conversion equipment, when properly applied and operated within specified conditions, against faulty materials or workmanship for a period of two years for E91-Series products from the date of purchase. XPC Corporation warrants internal batteries for a period of two years from the date of purchase. For equipment sites within the United States and Canada, this warranty covers repair or replacement, at the sole discretion of XPC Corporation. The customer is responsible for the costs of shipping the defective product to XPC Corporation. XPC Corporation will pay for ground shipment of the repaired or replacement product. The limited warranty does not cover on-site labor. This warranty applies only to the original purchaser. Warranty void if equipment is commissioned by non-factory trained personnel.

If equipment provided by XPC Corporation is found to be Dead-on-Arrival (DOA), the customer must request and receive a Return Material Authorization (RMA) number. DOA equipment is defined as equipment that does not properly function according to user documentation when initially received and connected in conjunction with proper procedures as shown in the user documentation or via support provided by XPC Corporation personnel or authorized agents.

This warranty shall be void if (a) the equipment is repaired or modified by anyone other than XPC Corporation or a XPC Corporation approved third party; (b) the equipment is damaged by the customer, is improperly used or stored, is subjected to an adverse operating environment, or is operated outside the limits of its electrical specifications; or (c) the equipment has been used or stored in a manner contrary to the equipment's operating manual, intended use or other written instructions, ; or (d) the equipment is damaged due to improper installation or startup. Any technical advice furnished by XPC Corporation or a XPC Corporation authorized representative before or after delivery with regard to the use or application of Xtreme Power Conversion equipment is furnished on the basis that it represents XPC Corporations best judgment under the situation and circumstances, but it is used at the recipient's sole risk.

EXCEPT AS STATED ABOVE, XPC Corporation DISCLAIMS ALL WARRANTIES, EXPRESSED OR IMPLIED, INCLUDING WARRANTIES OF MERCHANTABILITY AND FITNESS FOR A PARTICULAR PURPOSE.

EXCEPT AS STATED ABOVE, IN NO EVENT WILL XPC Corporation BE LIABLE FOR DIRECT, INDIRECT, SPECIAL, INCIDENTAL, OR CONSEQUENTIAL DAMAGES ARISING OUT OF THE USE OF Xtreme Power Conversion EQUIPMENT, including but not limited to, any costs, lost profits or revenue, loss of equipment, loss of use of equipment, loss of software, loss of data, cost of substitutes, or claims by third parties. Purchaser's sole and exclusive remedy for breach of any warranty, expressed or implied, concerning Xtreme Power Conversion equipment, and the only obligation of XPC Corporation under this warranty, shall be the repair or replacement of defective equipment, components, or parts; or, at XPC Corporations sole discretion, refund of the purchase price or substitution of an equivalent replacement product.

XPC Corporation  
230 Yuma Street  
Denver, CO 80223  
1.800.582.4524