

Galaxy VS

UPS for External Batteries

Technical Specifications

20-150 kW 480 V
10-75 kW 208 V

Latest updates are available on the Schneider Electric website
7/2023



Legal Information

The Schneider Electric brand and any trademarks of Schneider Electric SE and its subsidiaries referred to in this guide are the property of Schneider Electric SE or its subsidiaries. All other brands may be trademarks of their respective owners.

This guide and its content are protected under applicable copyright laws and furnished for informational use only. No part of this guide may be reproduced or transmitted in any form or by any means (electronic, mechanical, photocopying, recording, or otherwise), for any purpose, without the prior written permission of Schneider Electric.

Schneider Electric does not grant any right or license for commercial use of the guide or its content, except for a non-exclusive and personal license to consult it on an "as is" basis. Schneider Electric products and equipment should be installed, operated, serviced, and maintained only by qualified personnel.

As standards, specifications, and designs change from time to time, information contained in this guide may be subject to change without notice.

To the extent permitted by applicable law, no responsibility or liability is assumed by Schneider Electric and its subsidiaries for any errors or omissions in the informational content of this material or consequences arising out of or resulting from the use of the information contained herein.



**Find the manuals here:
Trouvez les manuels ici:**



https://www.productinfo.schneider-electric.com/galaxyvs_ul/

Table of Contents

Important Safety Instructions — SAVE THESE INSTRUCTIONS	5
FCC Statement	6
Safety Precautions	6
ENERGY STAR Qualification.....	7
Model list	8
UL 924 and CSA 22.2 NO. 141-15 Solutions.....	10
Single System Overview.....	13
Parallel System Overview.....	14
Input Voltage Window	17
Inverter Short Circuit Capabilities (Bypass not Available)	19
Efficiency.....	22
Derating Due to Load Power Factor.....	26
Batteries	27
End of Discharge Voltage	27
Standard VRLA Voltage Levels	27
Compliance.....	29
Regional Seismic Compliance	29
Communication and Management	30
EPO	30
Configurable Input Contacts and Output Relays.....	31
Requirements for a Third Party Battery Solution.....	32
Third Party Battery Breaker Requirements.....	32
Guidance for Organizing Battery Cables.....	33
Specifications for 480 V Systems	34
Input Specifications 480 V	34
Bypass Specifications 480 V	35
Output Specifications 480 V	36
Battery Specifications 480 V.....	37
Recommended Cable Sizes 480 V.....	38
Recommended Upstream Protection 480 V	40
Specifications for 208 V Systems	42
Input Specifications 208 V	42
Bypass Specifications 208 V	42
Output Specifications 208 V	43
Battery Specifications 208 V.....	44
Recommended Cable Sizes 208 V.....	45
Recommended Upstream Protection 208 V	47
Recommended Bolt and Lug Sizes for UL	49
Torque Specifications	51
Physical	52
UPS Shipping Weights and Dimensions	52
UPS Weights and Dimensions	53
Clearance	54
Environment.....	55

Heat Dissipation in BTU/hr 56

Heat Dissipation for Maintenance Bypass Cabinet with Transformer in
BTU/hr..... 59

Heat Dissipation for Input Transformer Cabinet in BTU/hr 59

Drawings 60

 20-50 kW 480 V and 10-25 kW 208 V UPS 61

 60-100 kW 480 V and 30-50 kW 208 V UPS..... 62

 120-150 kW 480 V and 60-75 kW 208 V UPS..... 63

Options 64

 Configuration Options 64

 Hardware Options..... 65

 Weights and Dimensions for Options..... 68

 Maintenance Bypass Cabinet Shipping Weights and
 Dimensions 68

 Maintenance Bypass Cabinet Weights and Dimensions 68

 Maintenance Bypass Cabinet with Transformer Shipping Weights and
 Dimensions 68

 Maintenance Bypass Cabinet with Transformer Weights and
 Dimensions 68

 Classic Battery Cabinet Shipping Weights and Dimensions 69

 Classic Battery Cabinet Weights and Dimensions..... 69

 Modular Battery Cabinet Shipping Weights and Dimensions..... 69

 Modular Battery Cabinet Weights and Dimensions 70

 Input Transformer Cabinet Shipping Weights and Dimensions..... 70

 Input Transformer Cabinet Weights and Dimensions 70

 Remote Alarm Panel Shipping Weights and Dimensions..... 70

 Remote Alarm Panel Weights and Dimensions..... 70

Limited Factory Warranty..... 71

Important Safety Instructions — SAVE THESE INSTRUCTIONS

Read these instructions carefully and look at the equipment to become familiar with it before trying to install, operate, service or maintain it. The following safety messages may appear throughout this manual or on the equipment to warn of potential hazards or to call attention to information that clarifies or simplifies a procedure.



The addition of this symbol to a “Danger” or “Warning” safety message indicates that an electrical hazard exists which will result in personal injury if the instructions are not followed.



This is the safety alert symbol. It is used to alert you to potential personal injury hazards. Obey all safety messages with this symbol to avoid possible injury or death.

DANGER

DANGER indicates a hazardous situation which, if not avoided, **will result in death or serious injury.**

Failure to follow these instructions will result in death or serious injury.

WARNING

WARNING indicates a hazardous situation which, if not avoided, **could result in death or serious injury.**

Failure to follow these instructions can result in death, serious injury, or equipment damage.

CAUTION

CAUTION indicates a hazardous situation which, if not avoided, **could result in minor or moderate injury.**

Failure to follow these instructions can result in injury or equipment damage.

NOTICE

NOTICE is used to address practices not related to physical injury. The safety alert symbol shall not be used with this type of safety message.

Failure to follow these instructions can result in equipment damage.

Please Note

Electrical equipment should only be installed, operated, serviced, and maintained by qualified personnel. No responsibility is assumed by Schneider Electric for any consequences arising out of the use of this material.

A qualified person is one who has skills and knowledge related to the construction, installation, and operation of electrical equipment and has received safety training to recognize and avoid the hazards involved.

FCC Statement

NOTE: This equipment has been tested and found to comply with the limits for a Class A digital device, pursuant to Part 15 of the FCC Rules. These limits are designed to provide reasonable protection against harmful interference when the equipment is operated in a commercial environment. This equipment generates, uses, and can radiate radio frequency energy and, if not installed and used in accordance with the instruction manual, may cause harmful interference to radio communications. Operation of this equipment in a residential area is likely to cause harmful interference in which case the user will be required to correct the interference at his own expense.

Any changes or modifications not expressly approved by the party responsible for compliance could void the user's authority to operate the equipment.

Safety Precautions

⚠ DANGER

HAZARD OF ELECTRIC SHOCK, EXPLOSION, OR ARC FLASH

- The product must be installed according to the specifications and requirements as defined by Schneider Electric. It concerns in particular the external and internal protections (upstream circuit breakers, battery circuit breakers, cabling, etc.) and environmental requirements. No responsibility is assumed by Schneider Electric if these requirements are not respected.
- After the UPS system has been electrically wired, do not start up the system. Start-up must only be performed by Schneider Electric.

Failure to follow these instructions will result in death or serious injury.

⚠ DANGER

HAZARD OF ELECTRIC SHOCK, EXPLOSION, OR ARC FLASH

The UPS System must be installed according to local and national regulations. Install the UPS according to:

- IEC 60364 (including 60364-4-41- protection against electric shock, 60364-4-42 - protection against thermal effect, and 60364-4-43 - protection against overcurrent), **or**
- NEC NFPA 70

depending on which one of the standards apply in your local area.

Failure to follow these instructions will result in death or serious injury.

⚠ DANGER

HAZARD OF ELECTRIC SHOCK, EXPLOSION, OR ARC FLASH

- Install the UPS system in a temperature controlled area free of conductive contaminants and humidity.
- Install the UPS system on a non-flammable, level, and solid surface (e.g. concrete) that can support the weight of the system.

Failure to follow these instructions will result in death or serious injury.

⚠ DANGER

HAZARD OF ELECTRIC SHOCK, EXPLOSION, OR ARC FLASH

The UPS is not designed for and must therefore not be installed in the following unusual operating environments:

- Damaging fumes
- Explosive mixtures of dust or gases, corrosive gases, or conductive or radiant heat from other sources
- Moisture, abrasive dust, steam or in an excessively damp environment
- Fungus, insects, vermin
- Salt-laden air or contaminated cooling refrigerant
- Pollution degree higher than 2 according to IEC 60664-1
- Exposure to abnormal vibrations, shocks, and tilting
- Exposure to direct sunlight, heat sources, or strong electromagnetic fields

Failure to follow these instructions will result in death or serious injury.

NOTICE

RISK OF OVERHEATING

Respect the clearance requirements around the UPS system and do not cover the product's ventilation openings when the UPS system is in operation.

Failure to follow these instructions can result in equipment damage.

NOTICE

RISK OF EQUIPMENT DAMAGE

Do not connect the UPS output to regenerative load systems including photovoltaic systems and speed drives.

Failure to follow these instructions can result in equipment damage.

ENERGY STAR Qualification



Select models are ENERGY STAR® qualified. For more information on your specific model go to www.se.com.

Model list



UPS Models for External Batteries

- Galaxy VS UPS 20 kW 480 V, for external batteries, start-up 5x8 (GVSUPS20KGS)
- Galaxy VS UPS 30 kW 480 V, for external batteries, start-up 5x8 (GVSUPS30KGS)
- Galaxy VS UPS 40 kW 480 V, for external batteries, start-up 5x8 (GVSUPS40KGS)
- Galaxy VS UPS 50 kW 480 V, for external batteries, start-up 5x8 (GVSUPS50KGS)
- Galaxy VS UPS 60 kW 480 V, for external batteries, start-up 5x8 (GVSUPS60KGS)
- Galaxy VS UPS 80 kW 480 V, for external batteries, start-up 5x8 (GVSUPS80KGS)
- Galaxy VS UPS 100 kW 480 V, for external batteries, start-up 5x8 (GVSUPS100KGS)
- Galaxy VS UPS 120 kW 480 V, for external batteries, start-up 5x8 (GVSUPS120KGS)
- Galaxy VS UPS 150 kW 480 V, for external batteries, start-up 5x8 (GVSUPS150KGS)
- Galaxy VS UPS 10 kW 208 V, for external batteries, start-up 5x8 (GVSUPS10KFS)
- Galaxy VS UPS 15 kW 208 V, for external batteries, start-up 5x8 (GVSUPS15KFS)
- Galaxy VS UPS 20 kW 208 V, for external batteries, start-up 5x8 (GVSUPS20KFS)
- Galaxy VS UPS 25 kW 208 V, for external batteries, start-up 5x8 (GVSUPS25KFS)
- Galaxy VS UPS 30 kW 208 V, for external batteries, start-up 5x8 (GVSUPS30KFS)
- Galaxy VS UPS 40 kW 208 V, for external batteries, start-up 5x8 (GVSUPS40KFS)
- Galaxy VS UPS 50 kW 208 V, for external batteries, start-up 5x8 (GVSUPS50KFS)
- Galaxy VS UPS 60 kW 208 V, for external batteries, start-up 5x8 (GVSUPS60KFS)
- Galaxy VS UPS 75 kW 208 V, for external batteries, start-up 5x8 (GVSUPS75KFS)

UPS Models for External Batteries with N+1 Power Module

- Galaxy VS UPS 20 kW 480 V, with N+1 power module for external batteries, start-up 5x8 (GVSUPS20KRGS)
- Galaxy VS UPS 30 kW 480 V, with N+1 power module for external batteries, start-up 5x8 (GVSUPS30KRGS)
- Galaxy VS UPS 40 kW 480 V, with N+1 power module for external batteries, start-up 5x8 (GVSUPS40KRGS)
- Galaxy VS UPS 50 kW 480 V, with N+1 power module for external batteries, start-up 5x8 (GVSUPS50KRGS)
- Galaxy VS UPS 60 kW 480 V, with N+1 power module for external batteries, start-up 5x8 (GVSUPS60KRGS)
- Galaxy VS UPS 80 kW 480 V, with N+1 power module for external batteries, start-up 5x8 (GVSUPS80KRGS)
- Galaxy VS UPS 100 kW 480 V, with N+1 power module for external batteries, start-up 5x8 (GVSUPS100KRGS)
- Galaxy VS UPS 10 kW 208 V, with N+1 power module for external batteries, start-up 5x8 (GVSUPS10KRFS)
- Galaxy VS UPS 15 kW 208 V, with N+1 power module for external batteries, start-up 5x8 (GVSUPS15KRFS)
- Galaxy VS UPS 20 kW 208 V, with N+1 power module for external batteries, start-up 5x8 (GVSUPS20KRFS)
- Galaxy VS UPS 25 kW 208 V, with N+1 power module for external batteries, start-up 5x8 (GVSUPS25KRFS)
- Galaxy VS UPS 30 kW 208 V, with N+1 power module for external batteries, start-up 5x8 (GVSUPS30KRFS)
- Galaxy VS UPS 40 kW 208 V, with N+1 power module for external batteries, start-up 5x8 (GVSUPS40KRFS)
- Galaxy VS UPS 50 kW 208 V, with N+1 power module for external batteries, start-up 5x8 (GVSUPS50KRFS)

Scalable UPS Models for External Batteries

- Galaxy VS UPS 50 kW 480 V scalable to 150 kW for external batteries, halogen-free cables, start-up 5x8 (GVSUPS50K150GS)
- Galaxy VS UPS 25 kW 208 V scalable to 75 kW for external batteries, halogen-free cables, start-up 5x8 (GVSUPS25K75FS)

UL 924 and CSA 22.2 NO. 141-15 Solutions

NOTE: In solutions with two classic battery cabinets of the type GVSCBT1ST, GVSCBT2ST, GVSCBT3ST, GVSCBT4ST, or GVSCBT5ST, the GVSOPT011 cable kit is needed for the second battery cabinet.

NOTE: In solutions with two or more classic battery cabinets of the type GVSCBT6ST, one GVSOPT028 cable kit is needed.

UL 924 Solutions (90 Minutes Runtime)

NOTE: The Lithium-ion battery cabinet LIBSESMG13UL requires a minimum charge time of 24 hours to reach full battery capacity. The Lithium-ion battery cabinet LIBSESMG16UL requires a minimum charge time of 36 hours to reach full battery capacity. The minimum charge time to reach full battery capacity is based on the UPS operating with 100% load and at 85% undervoltage.

UPS			Classic battery cabinet	Lithium-ion battery cabinet
Voltage (V)	UPS rating	Commercial reference	Commercial reference	Commercial reference
480 V	20 kW	GVSUPS20KGS or GVSUPS20KRGS	2 x GVSCBT3ST or 1 x GVSCBT6ST	2 x LIBSESMG13UL or 1 x LIBSESMG16UL
	30 kW	GVSUPS30KGS or GVSUPS30KRGS	2 x GVSCBT4ST or 2 x GVSCBT5ST	2 x LIBSESMG13UL or 2 x LIBSESMG16UL
	40 kW	GVSUPS40KGS or GVSUPS40KRGS	2 x GVSCBT6ST	3 x LIBSESMG13UL or 2 x LIBSESMG16UL
	50 kW	GVSUPS50KGS or GVSUPS50KRGS	3 x GVSCBT6ST	3 x LIBSESMG16UL
	60 kW	GVSUPS60KGS or GVSUPS60KRGS	3 x GVSCBT6ST	3 x LIBSESMG16UL
	80 kW	GVSUPS80KGS or GVSUPS80KRGS	4 x GVSCBT6ST	4 x LIBSESMG16UL
	100 kW	GVSUPS100KGS or GVSUPS100KRGS	5 x GVSCBT6ST	5 x LIBSESMG16UL
208 V	10 kW	GVSUPS10KFS or GVSUPS10KRFS	1 x GVSCBT3ST or 1 x GVSCBT4ST	1 x LIBSESMG13UL or 1 x LIBSESMG16UL
	15 kW	GVSUPS15KFS or GVSUPS15KRFS	1 x GVSCBT4ST or 1 x GVSCBT5ST	1 x LIBSESMG13UL or 1 x LIBSESMG16UL
	20 kW	GVSUPS20KFS or GVSUPS20KRFS	2 x GVSCBT3ST or 1 x GVSCBT6ST	2 x LIBSESMG13UL or 1 x LIBSESMG16UL
	25 kW	GVSUPS25KFS or GVSUPS25KRFS	2 x GVSCBT4ST or 2 x GVSCBT5ST	2 x LIBSESMG16UL
	30 kW	GVSUPS30KFS or GVSUPS30KRFS	2 x GVSCBT4ST or 2 x GVSCBT5ST	2 x LIBSESMG13UL or 2 x LIBSESMG16UL
	40 kW	GVSUPS40KFS or GVSUPS40KRFS	2 x GVSCBT6ST	3 x LIBSESMG13UL or 2 x LIBSESMG16UL
	50 kW	GVSUPS50KFS or GVSUPS50KRFS	3 x GVSCBT6ST	3 x LIBSESMG16UL

CSA 22.2 NO. 141-15 Solutions (30 Minutes Runtime)

UPS			Classic battery cabinet
Voltage (V)	UPS rating	Commercial reference	Commercial reference
480 V	20 kW	GVSUPS20KGS or GVSUPS20KRGS	1 x GVSCBT3ST or 1 x GVSCBT4ST
	30 kW	GVSUPS30KGS or GVSUPS30KRGS	1 x GVSCBT4ST or 1 x GVSCBT5ST

UPS			Classic battery cabinet
Voltage (V)	UPS rating	Commercial reference	Commercial reference
	40 kW	GVSUPS40KGS or GVSUPS40KRGS	1 x GVSCBT5ST or 1 x GVSCBT6ST
	50 kW	GVSUPS50KGS or GVSUPS50KRGS	2 x GVSCBT4ST or 1 x GVSCBT6ST
	60 kW	GVSUPS60KGS or GVSUPS60KRGS	2 x GVSCBT4ST or 2 x GVSCBT5ST
	80 kW	GVSUPS80KGS or GVSUPS80KRGS	2 x GVSCBT5ST or 2 x GVSCBT6ST
	100 kW	GVSUPS100KGS or GVSUPS100KRGS	2 x GVSCBT6ST
208 V	10 kW	GVSUPS10KFS or GVSUPS10KRFS	1 x GVSCBT1ST or 1 x GVSCBT2ST
	15 kW	GVSUPS15KFS or GVSUPS15KRFS	1 x GVSCBT2ST or 1 x GVSCBT3ST
	20 kW	GVSUPS20KFS or GVSUPS20KRFS	1 x GVSCBT3ST or 1 x GVSCBT4ST
	25 kW	GVSUPS25KFS or GVSUPS25KRFS	1 x GVSCBT4ST or 1 x GVSCBT5ST
	30 kW	GVSUPS30KFS or GVSUPS30KRFS	1 x GVSCBT4ST or 1 x GVSCBT5ST
	40 kW	GVSUPS40KFS or GVSUPS40KRFS	1 x GVSCBT5ST or 1 x GVSCBT6ST
	50 kW	GVSUPS50KFS or GVSUPS50KRFS	2 x GVSCBT4ST or 1 x GVSCBT6ST

CSA 22.2 NO. 141-15 Solutions (60 Minutes Runtime)

UPS			Classic battery cabinet
Voltage (V)	UPS rating	Commercial reference	Commercial reference
480 V	20 kW	GVSUPS20KGS or GVSUPS20KRGS	1 x GVSCBT4ST or 1 x GVSCBT5ST
	30 kW	GVSUPS30KGS or GVSUPS30KRGS	2 x GVSCBT4ST
	40 kW	GVSUPS40KGS or GVSUPS40KRGS	2 x GVSCBT4ST or 2 x GVSCBT5ST
	50 kW	GVSUPS50KGS or GVSUPS50KRGS	2 x GVSCBT5ST or 2 x GVSCBT6ST
	60 kW	GVSUPS60KGS or GVSUPS60KRGS	2 x GVSCBT6ST
	80 kW	GVSUPS80KGS or GVSUPS80KRGS	3 x GVSCBT6ST
	100 kW	GVSUPS100KGS or GVSUPS100KRGS	4 x GVSCBT6ST
208 V	10 kW	GVSUPS10KFS or GVSUPS10KRFS	1 x GVSCBT2ST or 1 x GVSCBT3ST
	15 kW	GVSUPS15KFS or GVSUPS15KRFS	1 x GVSCBT4ST or 1 x GVSCBT5ST
	20 kW	GVSUPS20KFS or GVSUPS20KRFS	1 x GVSCBT4ST or 1 x GVSCBT5ST
	25 kW	GVSUPS25KFS or GVSUPS25KRFS	1 x GVSCBT5ST or 1 x GVSCBT6ST
	30 kW	GVSUPS30KFS or GVSUPS30KRFS	2 x GVSCBT4ST
	40 kW	GVSUPS40KFS or GVSUPS40KRFS	2 x GVSCBT4ST or 2 x GVSCBT5ST
	50 kW	GVSUPS50KFS or GVSUPS50KRFS	2 x GVSCBT5ST or 2 x GVSCBT6ST

CSA 22.2 NO. 141-15 Solutions (120 Minutes Runtime)

UPS			Classic battery cabinet
Voltage (V)	UPS rating	Commercial reference	Commercial reference
480 V	20 kW	GVSUPS20KGS or GVSUPS20KRGS	2 x GVSCBT4ST or 2 x GVSCBT5ST
	30 kW	GVSUPS30KGS or GVSUPS30KRGS	2 x GVSCBT5ST or 2 x GVSCBT6ST
	40 kW	GVSUPS40KGS or GVSUPS40KRGS	3 x GVSCBT6ST
	50 kW	GVSUPS50KGS or GVSUPS50KRGS	3 x GVSCBT6ST
	60 kW	GVSUPS60KGS or GVSUPS60KRGS	4 x GVSCBT6ST
	80 kW	GVSUPS80KGS or GVSUPS80KRGS	5 x GVSCBT6ST

UPS			Classic battery cabinet
Voltage (V)	UPS rating	Commercial reference	Commercial reference
	100 kW	GVSUPS100KGS or GVSUPS100KRGS	NA
208 V	10 kW	GVSUPS10KFS or GVSUPS10KRFS	1 x GVSCBT4ST or 1 x GVSCBT5ST
	15 kW	GVSUPS15KFS or GVSUPS15KRFS	1 x GVSCBT6ST
	20 kW	GVSUPS20KFS or GVSUPS20KRFS	2 x GVSCBT4ST or 2 x GVSCBT5ST
	25 kW	GVSUPS25KFS or GVSUPS25KRFS	2 x GVSCBT4ST or 2 x GVSCBT5ST
	30 kW	GVSUPS30KFS or GVSUPS30KRFS	2 x GVSCBT5ST or 2 x GVSCBT6ST
	40 kW	GVSUPS40KFS or GVSUPS40KRFS	3 x GVSCBT6ST
	50 kW	GVSUPS50KFS or GVSUPS50KRFS	3 x GVSCBT6ST

Single System Overview

UIB	Unit input breaker
SSIB	Static switch input breaker
IMB	Internal maintenance breaker
UOB	Unit output breaker
BB	Battery breaker

Single System – Single Mains

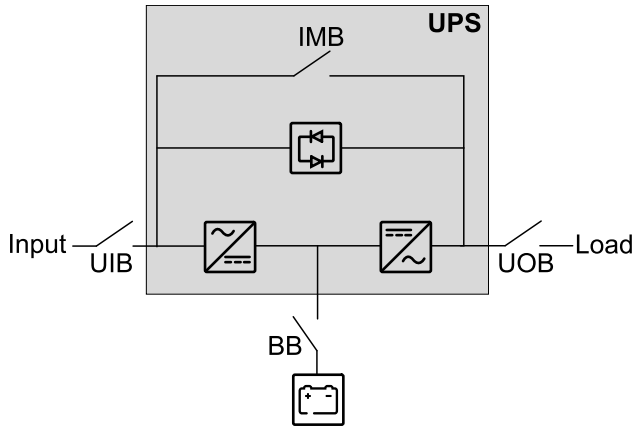

Single System – Dual Mains

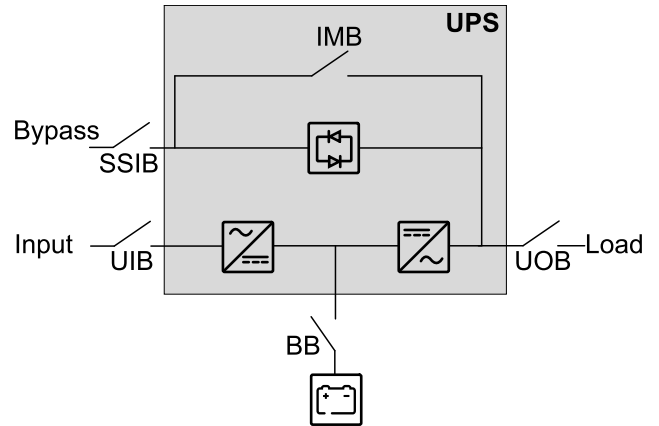

Parallel System Overview

UIB	Unit input breaker
SSIB	Static switch input breaker
IMB	Internal maintenance breaker
UOB	Unit output breaker
SIB	System isolation breaker
BB	Battery breaker
MBB	External maintenance bypass breaker

Simplified 1+1 Parallel System

Galaxy VS can support 2 UPSs in a simplified 1+1 parallel system for redundancy with shared unit input breaker UIB and static switch input breaker SSIB.

Simplified 1+1 Parallel System – Single Mains

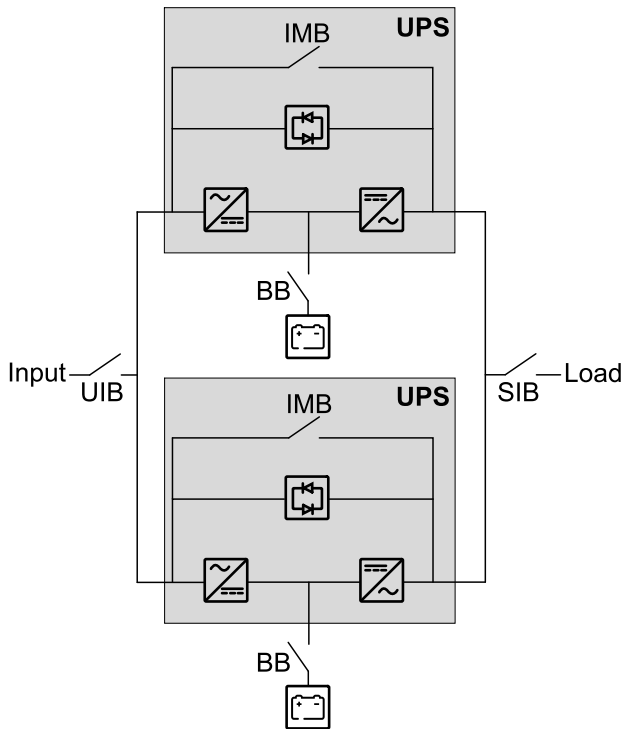

Simplified 1+1 Parallel System – Dual Mains

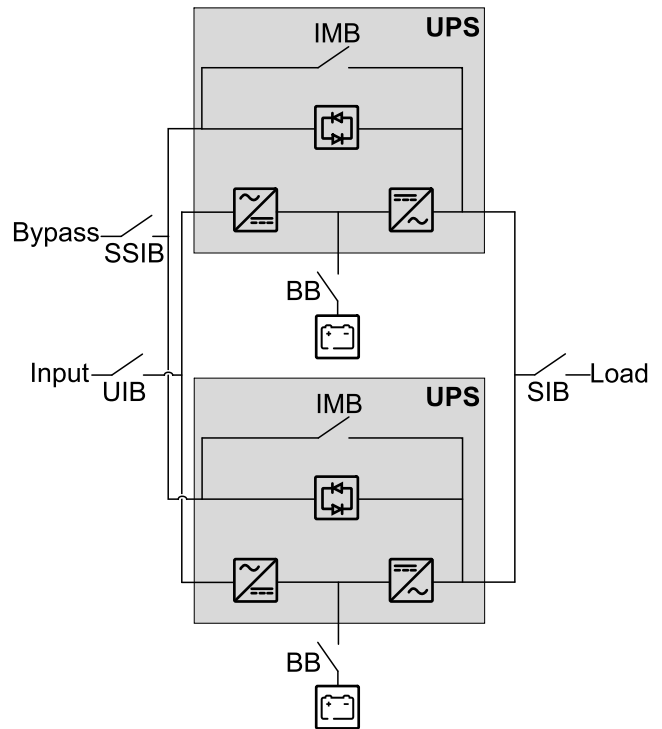

Parallel System with Individual Unit Input Breaker UIB and Static Switch Input Breaker SSIB

Galaxy VS can support up to 4 UPSs in parallel for capacity and up to 3+1 UPSs in parallel for redundancy with individual unit input breaker UIB and static switch input breaker SSIB.

NOTE: The internal maintenance breaker IMB can only be used in a simplified 1+1 parallel system. In any other parallel system, an external maintenance bypass breaker MBB must be provided and the internal maintenance breaker IMB* must be padlocked in the open position.

Parallel System – Single Mains

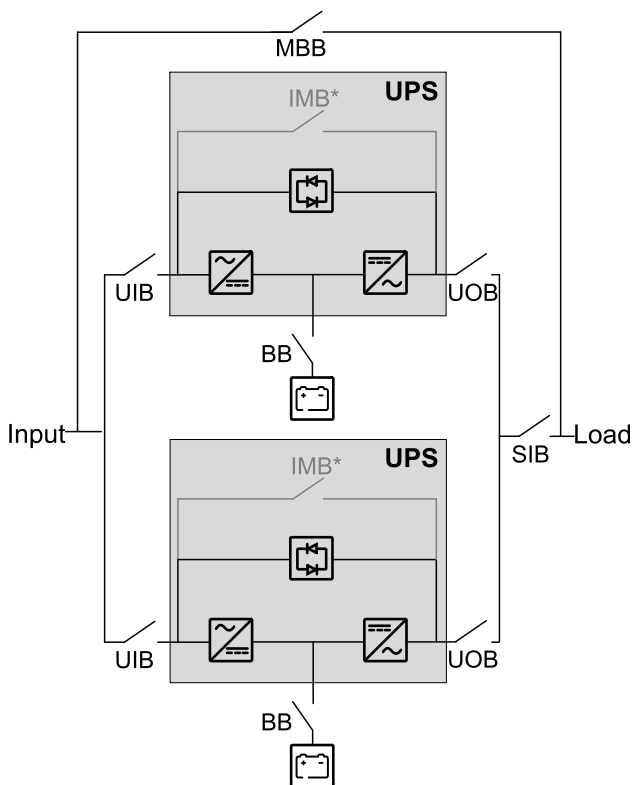

Parallel System – Dual Mains

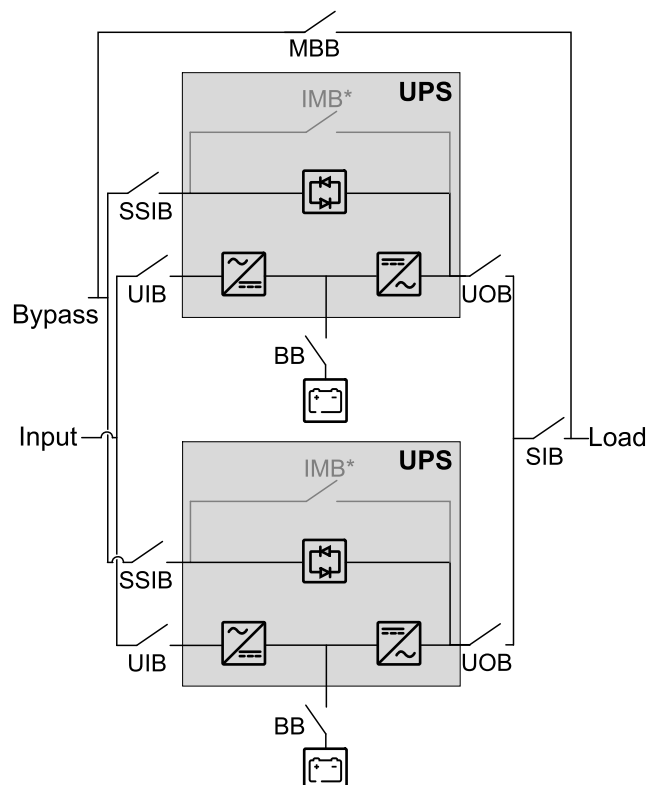

Parallel System with Shared Unit Input Breaker UIB and Static Switch Input Breaker SSIB

Galaxy VS can support up to 4 UPSs in parallel for capacity and up to 3+1 UPSs in parallel for redundancy with shared unit input breaker UIB and static switch input breaker SSIB.

NOTE: The internal maintenance breaker IMB can only be used in a simplified 1+1 parallel system. In any other parallel system, an external maintenance bypass breaker MBB must be provided and the internal maintenance breaker IMB* must be padlocked in the open position.

Parallel System – Single Mains

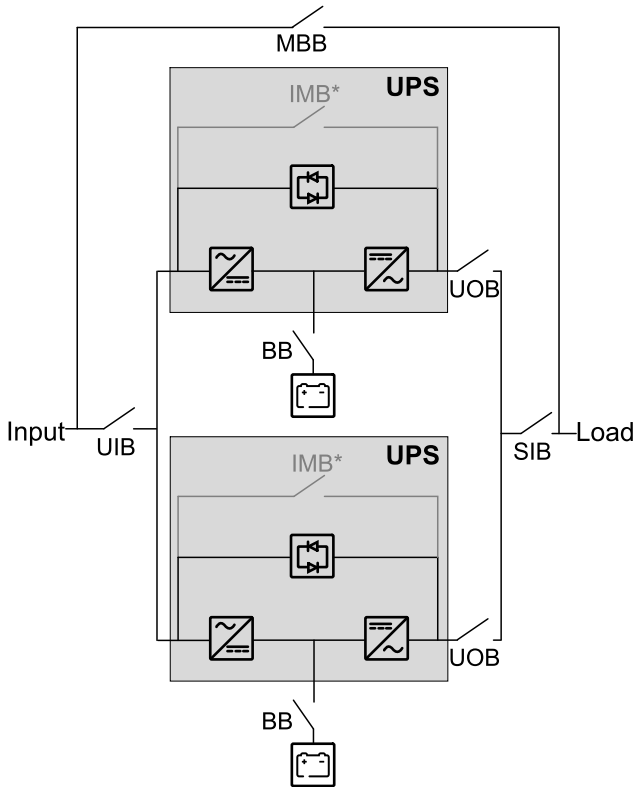

Parallel System – Dual Mains

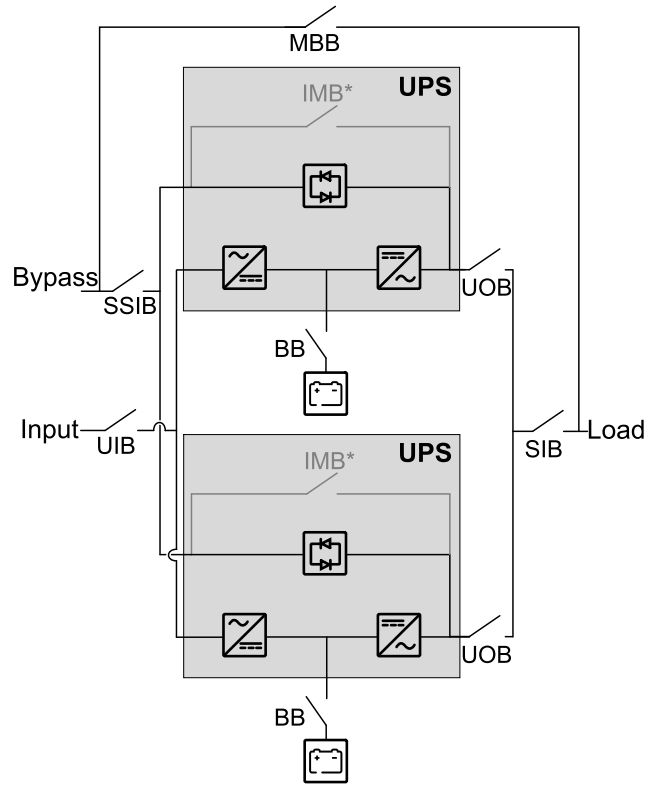

Input Voltage Window

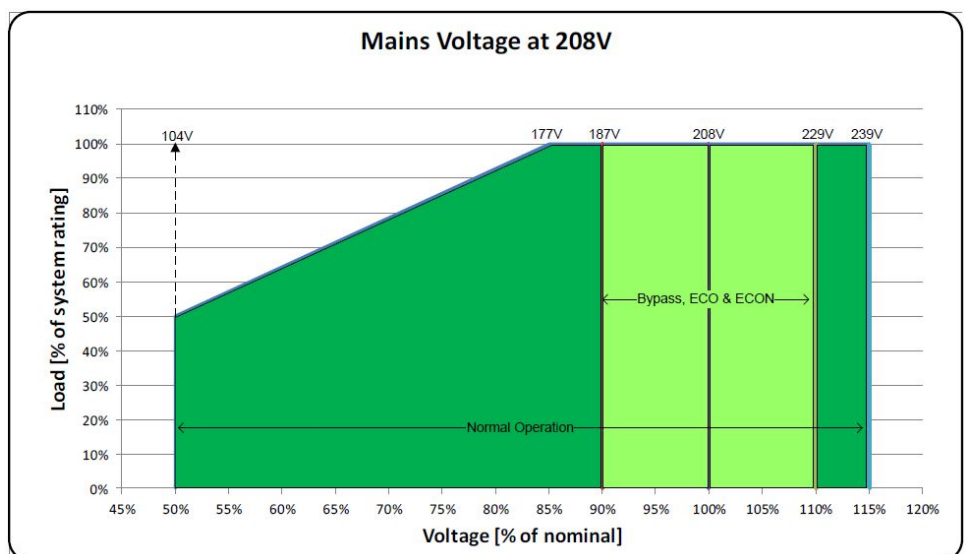
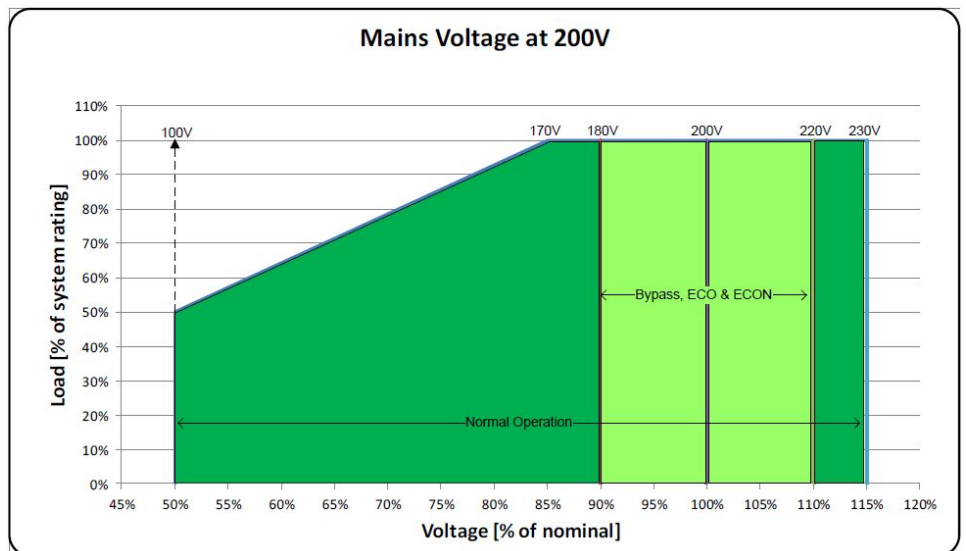
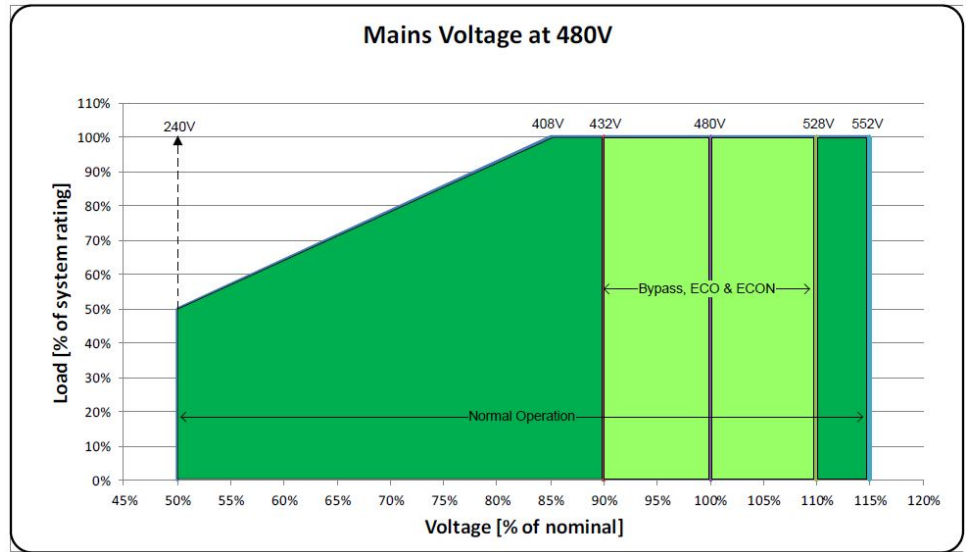

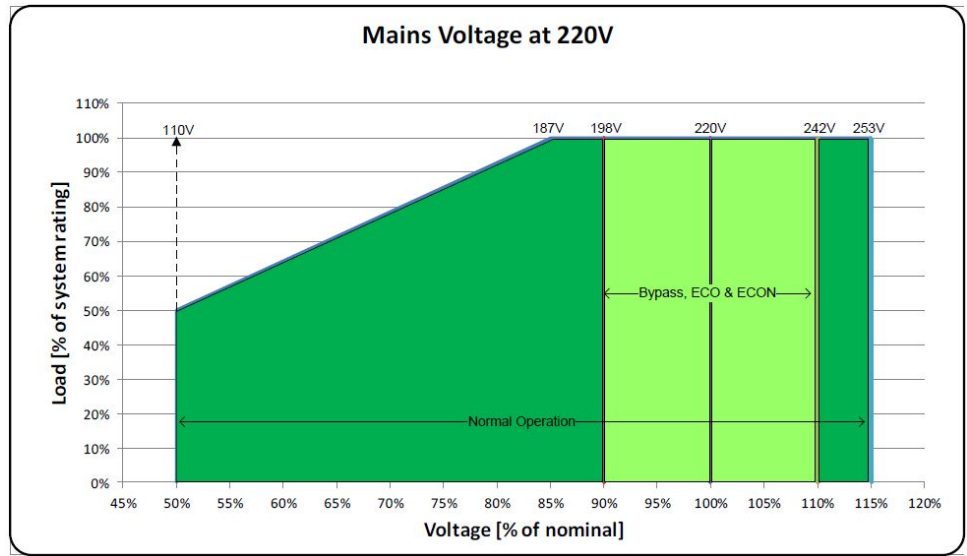

Inverter Short Circuit Capabilities (Bypass not Available)

IK1 – Short Circuit between a Phase and Neutral

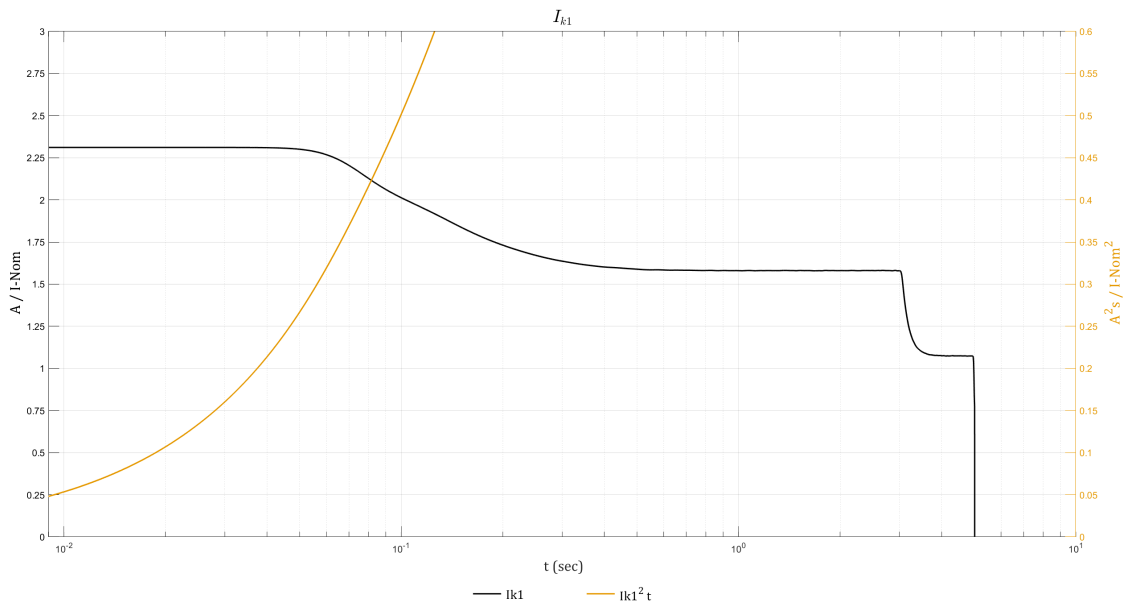

IK1 480 V

S [kVA]	10ms; I[A]/I ² t [A ² t]	20ms; I[A]/I ² t [A ² t]	30ms; I[A]/I ² t [A ² t]	100ms; I[A]/I ² t [A ² t]	1s; I[A]/I ² t [A ² t]
10	28 / 8	28 / 15	28 / 23	24 / 73	19 / 419
15	42 / 17	42 / 35	42 / 52	36 / 163	29 / 942
20	56 / 31	56 / 62	56 / 93	48 / 290	38 / 1674
30	83 / 70	83 / 140	83 / 210	73 / 650	57 / 3770
40	111 / 120	111 / 250	111 / 370	97 / 1160	76 / 6700
50	139 / 190	139 / 390	139 / 580	121 / 1810	95 / 10460
60	167 / 280	167 / 560	167 / 830	145 / 2610	114 / 15070
80	222 / 490	222 / 990	222 / 1480	194 / 4640	152 / 26790
100	278 / 770	278 / 1550	278 / 2320	242 / 7260	190 / 41860
120	334 / 1110	334 / 2230	334 / 3340	291 / 10450	228 / 60270
150	417 / 1740	417 / 3480	417 / 5220	363 / 16330	285 / 94180

IK1 208 V

S [kVA]	10ms; I[A]/I ² t [A ² t]	20ms; I[A]/I ² t [A ² t]	30ms; I[A]/I ² t [A ² t]	100ms; I[A]/I ² t [A ² t]	1s; I[A]/I ² t [A ² t]
10	64 / 41	64 / 82	64 / 123	56 / 386	44 / 2229
15	96 / 93	96 / 185	96 / 278	84 / 869	66 / 5015
20	128 / 160	128 / 330	128 / 490	112 / 1550	88 / 8920
25	160 / 260	160 / 510	160 / 770	140 / 2420	110 / 13930
30	192 / 370	192 / 740	192 / 1110	168 / 3480	132 / 20060
40	257 / 660	257 / 1320	257 / 1980	224 / 6180	175 / 35670
50	321 / 1030	321 / 2060	321 / 3090	279 / 9660	219 / 55730
60	385 / 1480	385 / 2960	385 / 4450	335 / 13910	263 / 80250
75	481 / 2320	481 / 4630	481 / 6950	419 / 21740	329 / 125390

IK2 – Short Circuit between Two Phases

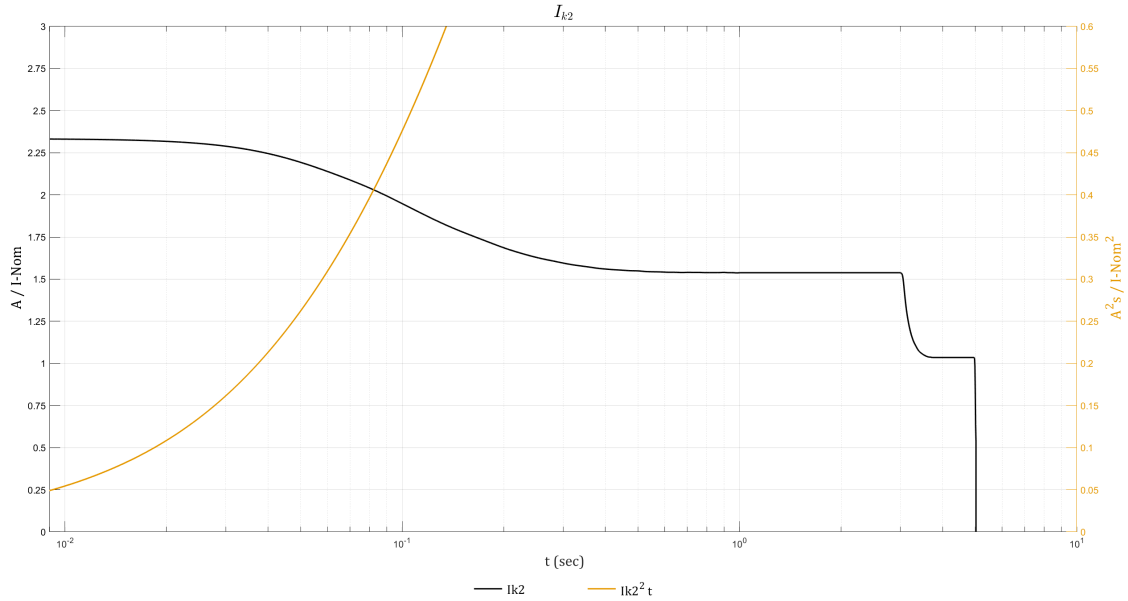

IK2 480 V

S [kVA]	10ms; I[A]/I ² t [A ² t]	20ms; I[A]/I ² t [A ² t]	30ms; I[A]/I ² t [A ² t]	100ms; I[A]/I ² t [A ² t]	1s; I[A]/I ² t [A ² t]
10	28 / 8	28 / 16	28 / 23	23 / 69	18 / 397
15	42 / 18	42 / 35	42 / 53	35 / 155	28 / 892
20	56 / 31	56 / 63	56 / 94	47 / 276	37 / 1586
30	84 / 70	84 / 140	84 / 210	70 / 620	55 / 3570
40	112 / 130	112 / 250	112 / 370	94 / 1100	74 / 6350
50	140 / 200	139 / 390	139 / 580	117 / 1720	92 / 9910
60	168 / 280	167 / 570	167 / 840	141 / 2480	111 / 14280
80	224 / 500	223 / 1000	223 / 1500	187 / 4410	148 / 25380
100	280 / 790	279 / 1570	279 / 2340	234 / 6890	185 / 39660
120	336 / 1130	335 / 2260	335 / 3370	281 / 9920	222 / 57110
150	421 / 1770	418 / 3530	418 / 5260	351 / 15500	277 / 89230

IK2 208 V

S [kVA]	10ms; I[A]/I ² t [A ² t]	20ms; I[A]/I ² t [A ² t]	30ms; I[A]/I ² t [A ² t]	100ms; I[A]/I ² t [A ² t]	1s; I[A]/I ² t [A ² t]
10	65 / 42	64 / 84	64 / 125	54 / 367	43 / 2112
15	97 / 94	96 / 188	96 / 280	81 / 825	64 / 4752
20	129 / 170	129 / 330	129 / 500	108 / 1470	85 / 8450
25	162 / 260	161 / 520	161 / 780	135 / 2290	107 / 13200
30	194 / 380	193 / 750	193 / 1120	162 / 3300	128 / 19010
40	259 / 670	257 / 1340	257 / 1990	216 / 5870	171 / 33790
50	323 / 1050	322 / 2090	322 / 3110	270 / 9170	213 / 52800
60	388 / 1510	386 / 3010	386 / 4480	324 / 13210	256 / 76030
75	485 / 2360	482 / 4700	482 / 7000	406 / 20630	320 / 118790

IK3 – Short Circuit between Three Phases

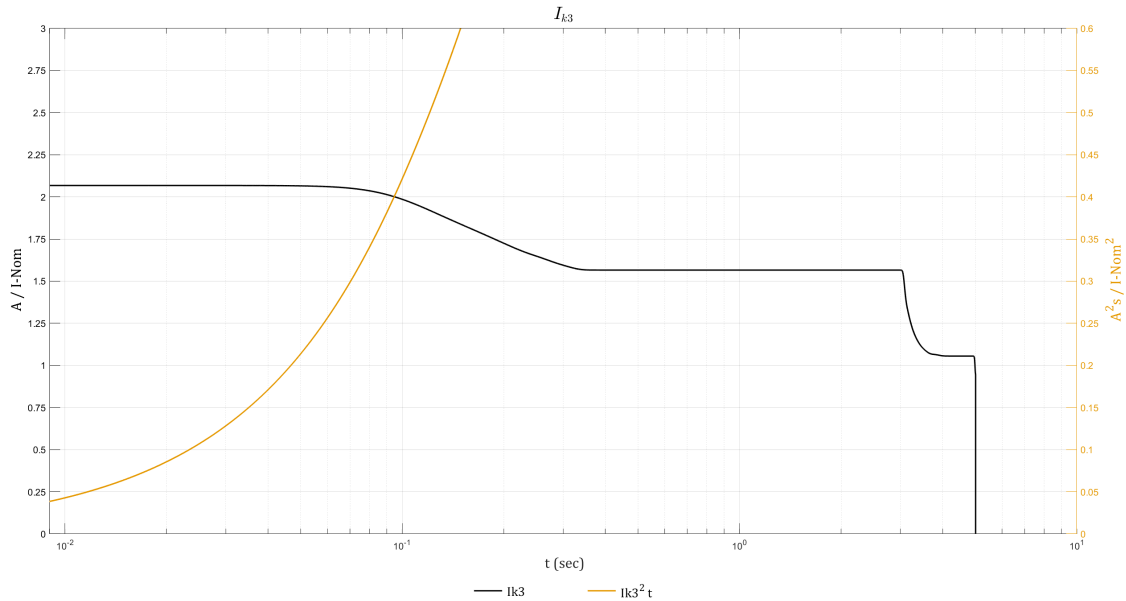

IK3 480 V

S [kVA]	10ms; I[A]/I ² t [A ² t]	20ms; I[A]/I ² t [A ² t]	30ms; I[A]/I ² t [A ² t]	100ms; I[A]/I ² t [A ² t]	1s; I[A]/I ² t [A ² t]
10	25 / 6	25 / 12	25 / 19	24 / 61	19 / 398
15	37 / 14	37 / 28	37 / 42	36 / 137	28 / 896
20	50 / 25	50 / 49	50 / 74	48 / 244	38 / 1593
30	75 / 60	75 / 110	75 / 170	72 / 550	57 / 3580
40	99 / 100	99 / 200	99 / 300	96 / 980	75 / 6370
50	124 / 150	124 / 310	124 / 460	119 / 1520	94 / 9960
60	149 / 220	149 / 450	149 / 670	143 / 2200	113 / 14340
80	199 / 400	199 / 790	199 / 1190	191 / 3900	151 / 25490
100	249 / 620	249 / 1240	249 / 1860	239 / 6100	188 / 39830
120	298 / 890	298 / 1780	298 / 2670	287 / 8780	226 / 57350
150	373 / 1390	373 / 2780	373 / 4180	358 / 13720	283 / 89610

IK3 208 V

S [kVA]	10ms; I[A]/I ² t [A ² t]	20ms; I[A]/I ² t [A ² t]	30ms; I[A]/I ² t [A ² t]	100ms; I[A]/I ² t [A ² t]	1s; I[A]/I ² t [A ² t]
10	57 / 33	57 / 66	57 / 99	55 / 325	43 / 2121
15	86 / 74	86 / 148	86 / 222	83 / 731	65 / 4772
20	115 / 130	115 / 260	115 / 400	110 / 1300	87 / 8480
25	143 / 210	143 / 410	143 / 620	138 / 2030	109 / 13260
30	172 / 300	172 / 590	172 / 890	165 / 2920	130 / 19090
40	230 / 530	230 / 1050	230 / 1580	220 / 5200	174 / 33940
50	287 / 820	287 / 1650	287 / 2470	276 / 8120	217 / 53020
60	344 / 1190	344 / 2370	344 / 3560	331 / 11690	261 / 76360
75	430 / 1850	430 / 3710	430 / 5560	413 / 18270	326 / 119310

Efficiency

480 V UPS

NOTE: The values for 60 kW, 120 kW, and 150 kW in battery operation are preliminary values.

Normal Operation

UPS rating	20 kW	30 kW	40 kW	50 kW	60 kW	80 kW	100 kW	120 kW	150 kW
25% load	93.6%	95.0%	95.8%	96.2%	95.8%	96.1%	96.5%	96.2%	96.3%
50% load	95.8%	96.5%	96.9%	97.1%	96.8%	97.1%	97.2%	97.1%	97.1%
75% load	96.5%	97.0%	97.2%	97.3%	97.2%	97.3%	97.4%	97.3%	97.3%
100% load	96.9%	97.2%	97.3%	97.2%	97.2%	97.3%	97.3%	97.2%	97.2%

ECO Mode

UPS rating	20 kW	30 kW	40 kW	50 kW	60 kW	80 kW	100 kW	120 kW	150 kW
25% load	96.8%	97.7%	98.2%	98.5%	98.3%	98.6%	98.8%	98.8%	98.9%
50% load	98.2%	98.7%	98.9%	99.1%	99.0%	99.1%	99.2%	99.2%	99.3%
75% load	98.7%	99.0%	99.2%	99.2%	99.2%	99.3%	99.3%	99.3%	99.4%
100% load	98.9%	99.2%	99.3%	99.3%	99.3%	99.3%	99.4%	99.4%	99.4%

eConversion

UPS rating	20 kW	30 kW	40 kW	50 kW	60 kW	80 kW	100 kW	120 kW	150 kW
25% load	94.9%	96.5%	97.2%	97.8%	97.5%	97.7%	98.1%	98.0%	98.1%
50% load	97.2%	98.1%	98.5%	98.8%	98.6%	98.8%	99.0%	98.8%	98.9%
75% load	98.1%	98.7%	98.9%	99.1%	98.9%	99.1%	99.2%	99.1%	99.1%
100% load	98.5%	98.9%	99.2%	99.3%	99.1%	99.3%	99.4%	99.2%	99.2%

Battery Operation

UPS rating	20 kW	30 kW	40 kW	50 kW	60 kW	80 kW	100 kW	120 kW	150 kW
25% load	93.5%	94.8%	95.4%	95.7%	94.9%	95.6%	96.0%	95.3%	96.0%
50% load	95.4%	95.9%	96.2%	96.4%	96.2%	96.5%	96.6%	96.3%	96.6%
75% load	95.9%	96.3%	96.4%	96.5%	96.6%	96.7%	96.7%	96.6%	96.7%
100% load	96.2%	96.4%	96.5%	96.5%	96.7%	96.7%	96.6%	96.6%	96.6%

208 V UPS

NOTE: The values for 30 kW, 60 kW, and 75 kW in battery operation are preliminary values.

10 kW	Normal operation			ECO mode		
Voltage (V)	200	208	220	200	208	220
25% load	90.4%	90.6%	90.9%	93.8%	93.6%	93.9%
50% load	93.3%	93.5%	93.6%	96.5%	96.4%	96.5%
75% load	94.3%	94.4%	94.7%	97.4%	97.3%	97.4%
100% load	94.6%	94.8%	95.1%	97.8%	97.8%	97.9%

10 kW	eConversion			Battery operation		
Voltage (V)	200	208	220	200	208	220
25% load	92.8%	93.3%	93.0%	91.6%	91.6%	91.6%
50% load	96.0%	96.3%	96.2%	94.0%	94.0%	94.0%
75% load	97.1%	97.3%	97.3%	94.8%	94.8%	94.8%
100% load	97.6%	97.9%	97.9%	95.2%	95.2%	95.2%

15 kW	Normal operation			ECO mode		
Voltage (V)	200	208	220	200	208	220
25% load	92.3%	92.5%	92.7%	95.5%	95.4%	95.7%
50% load	94.3%	94.4%	94.7%	97.4%	97.3%	97.4%
75% load	94.6%	94.9%	95.1%	98.0%	98.0%	98.0%
100% load	94.5%	94.8%	95.2%	98.3%	98.3%	98.3%

15 kW	eConversion			Battery operation		
Voltage (V)	200	208	220	200	208	220
25% load	95.0%	95.3%	95.0%	93.2%	93.2%	93.2%
50% load	97.1%	97.3%	97.3%	94.8%	94.8%	94.8%
75% load	97.8%	98.1%	98.1%	95.3%	95.3%	95.3%
100% load	98.2%	98.4%	98.4%	95.5%	95.5%	95.5%

20 kW	Normal operation			ECO mode		
Voltage (V)	200	208	220	200	208	220
25% load	93.3%	93.5%	93.6%	96.5%	96.4%	96.5%
50% load	94.6%	94.8%	95.1%	97.8%	97.8%	97.9%
75% load	94.5%	94.8%	95.2%	98.3%	98.3%	98.3%
100% load	94.1%	94.4%	94.9%	98.5%	98.5%	98.6%

20 kW	eConversion			Battery operation		
Voltage (V)	200	208	220	200	208	220
25% load	96.0%	96.3%	96.2%	94.0%	94.0%	94.0%
50% load	97.6%	97.9%	97.9%	95.2%	95.2%	95.2%
75% load	98.2%	98.4%	98.4%	95.5%	95.5%	95.5%
100% load	98.5%	98.7%	98.7%	95.5%	95.5%	95.5%

25 kW	Normal operation			ECO mode		
Voltage (V)	200	208	220	200	208	220
25% load	93.9%	94.1%	94.3%	97.4%	97.3%	97.1%
50% load	94.6%	94.9%	95.2%	98.1%	98.1%	98.2%
75% load	94.3%	94.6%	95.0%	98.4%	98.5%	98.5%
100% load	93.4%	93.9%	94.5%	98.6%	98.6%	98.7%

25 kW	eConversion			Battery operation		
Voltage (V)	200	208	220	200	208	220
25% load	96.6%	96.9%	96.9%	94.5%	94.5%	94.5%
50% load	97.9%	98.2%	98.2%	95.4%	95.4%	95.4%

25 kW	eConversion			Battery operation		
Voltage (V)	200	208	220	200	208	220
75% load	98.4%	98.6%	98.6%	95.5%	95.5%	95.5%
100% load	98.7%	98.8%	98.8%	95.5%	95.5%	95.5%

30 kW	Normal operation			ECO mode		
Voltage (V)	200	208	220	200	208	220
25% load	93.6%	93.8%	94.0%	96.8%	96.9%	96.9%
50% load	94.7%	94.9%	95.2%	98.0%	98.0%	98.1%
75% load	94.6%	94.9%	95.2%	98.3%	98.4%	98.5%
100% load	94.0%	94.4%	94.9%	98.5%	98.6%	98.6%

30 kW	eConversion			Battery operation		
Voltage (V)	200	208	220	200	208	220
25% load	96.6%	96.7%	96.6%	93.8%	93.8%	93.8%
50% load	97.9%	97.9%	97.9%	95.1%	95.1%	95.1%
75% load	98.3%	98.3%	98.4%	95.5%	95.5%	95.5%
100% load	98.4%	98.5%	98.6%	95.6%	95.6%	95.6%

40 kW	Normal operation			ECO mode		
Voltage (V)	200	208	220	200	208	220
25% load	93.9%	94.1%	94.6%	97.2%	97.3%	97.3%
50% load	94.9%	95.0%	95.6%	98.2%	98.2%	98.3%
75% load	94.7%	94.9%	95.6%	98.5%	98.5%	98.6%
100% load	94.2%	94.6%	95.3%	98.6%	98.7%	98.7%

40 kW	eConversion			Battery operation		
Voltage (V)	200	208	220	200	208	220
25% load	97.0%	97.0%	97.0%	94.4%	94.4%	94.4%
50% load	98.2%	98.2%	98.3%	95.4%	95.4%	95.4%
75% load	98.6%	98.7%	98.7%	95.6%	95.6%	95.6%
100% load	98.7%	98.7%	98.8%	95.6%	95.6%	95.6%

50 kW	Normal operation			ECO mode		
Voltage (V)	200	208	220	200	208	220
25% load	94.4%	94.5%	95.1%	97.6%	97.6%	97.7%
50% load	94.9%	95.0%	95.6%	98.4%	98.4%	98.5%
75% load	94.4%	94.7%	95.4%	98.6%	98.7%	98.7%
100% load	93.6%	94.0%	94.9%	98.7%	98.7%	98.8%

50 kW	eConversion			Battery operation		
Voltage (V)	200	208	220	200	208	220
25% load	97.5%	97.5%	97.4%	94.9%	94.9%	94.9%
50% load	98.5%	98.5%	98.6%	95.5%	95.5%	95.5%
75% load	98.7%	98.7%	98.7%	95.6%	95.6%	95.6%
100% load	98.8%	98.8%	98.8%	95.5%	95.5%	95.5%

60 kW	Normal operation			ECO mode		
Voltage (V)	200	208	220	200	208	220
25% load	94.4%	94.5%	94.7%	97.7%	97.7%	97.7%
50% load	94.9%	95.1%	95.4%	98.4%	98.4%	98.5%
75% load	94.4%	94.8%	95.2%	98.6%	98.6%	98.7%
100% load	93.6%	94.1%	94.6%	98.6%	98.7%	98.7%

60 kW	eConversion			Battery operation		
Voltage (V)	200	208	220	200	208	220
25% load	97.4%	97.4%	97.4%	94.1%	94.2%	94.2%
50% load	98.2%	98.3%	98.3%	95.2%	95.3%	95.4%
75% load	98.5%	98.5%	98.6%	95.3%	95.5%	95.7%
100% load	98.6%	98.6%	98.7%	95.3%	95.5%	95.7%

75 kW	Normal operation			ECO mode		
Voltage (V)	200	208	220	200	208	220
25% load	94.5%	94.6%	94.8%	97.9%	97.9%	97.9%
50% load	94.9%	95.1%	95.5%	98.4%	98.5%	98.5%
75% load	94.4%	94.7%	95.2%	98.6%	98.6%	98.7%
100% load	93.6%	94.0%	94.6%	98.6%	98.6%	98.7%

75 kW	eConversion			Battery operation		
Voltage (V)	200	208	220	200	208	220
25% load	97.6%	97.5%	97.6%	94.9%	94.9%	94.9%
50% load	98.3%	98.3%	98.4%	95.5%	95.5%	95.5%
75% load	98.5%	98.5%	98.6%	95.6%	95.6%	95.6%
100% load	98.5%	98.6%	98.6%	95.5%	95.5%	95.5%

Derating Due to Load Power Factor

0.7 leading to 0.7 lagging without derating.

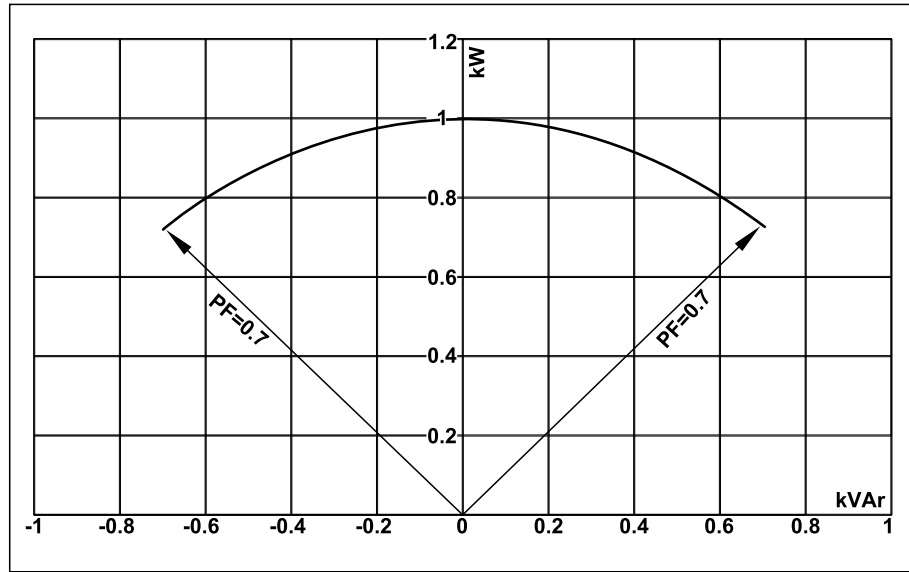

UPS rating	UPS output					
	Lagging			Leading		
PF=1	PF=0.7	PF=0.8	PF=0.9	PF=0.9	PF=0.8	PF=0.7
10 kVA/kW	10 kVA / 7 kW	10 kVA / 8 kW	10 kVA / 9 kW	10 kVA / 9 kW	10 kVA / 8 kW	10 kVA / 7 kW
15 kVA/kW	15 kVA / 10.5 kW	15 kVA / 12 kW	15 kVA / 13.5 kW	15 kVA / 13.5 kW	15 kVA / 12 kW	15 kVA / 10.5 kW
20 kVA/kW	20 kVA / 14 kW	20 kVA / 16 kW	20 kVA / 18 kW	20 kVA / 18 kW	20 kVA / 16 kW	20 kVA / 14 kW
25 kVA/kW	25 kVA / 17.5 kW	25 kVA / 20 kW	25 kVA / 22.5 kW	25 kVA / 22.5 kW	25 kVA / 20 kW	25 kVA / 17.5 kW
30 kVA/kW	30 kVA / 21 kW	30 kVA / 24 kW	30 kVA / 27 kW	30 kVA / 27 kW	30 kVA / 24 kW	30 kVA / 21 kW
40 kVA/kW	40 kVA / 28 kW	40 kVA / 32 kW	40 kVA / 36 kW	40 kVA / 36 kW	40 kVA / 32 kW	40 kVA / 28 kW
50 kVA/kW	50 kVA / 35 kW	50 kVA / 40 kW	50 kVA / 45 kW	50 kVA / 45 kW	50 kVA / 40 kW	50 kVA / 35 kW
60 kVA/kW	60 kVA / 42 kW	60 kVA / 48 kW	60 kVA / 54 kW	60 kVA / 54 kW	60 kVA / 48 kW	60 kVA / 42 kW
75 kVA/kW	75 kVA / 52.5 kW	75 kVA / 60 kW	75 kVA / 67.5 kW	75 kVA / 67.5 kW	75 kVA / 60 kW	75 kVA / 52.5 kW
80 kVA/kW	80 kVA / 56 kW	80 kVA / 64 kW	80 kVA / 72 kW	80 kVA / 72 kW	80 kVA / 64 kW	80 kVA / 56 kW
100 kVA/kW	100 kVA / 70 kW	100 kVA / 80 kW	100 kVA / 90 kW	100 kVA / 90 kW	100 kVA / 80 kW	100 kVA / 70 kW
120 kVA/kW	120 kVA / 84 kW	120 kVA / 96 kW	120 kVA / 108 kW	120 kVA / 108 kW	120 kVA / 96 kW	120 kVA / 84 kW
150 kVA/kW	150 kVA / 105 kW	150 kVA / 120 kW	150 kVA / 135 kW	150 kVA / 135 kW	150 kVA / 120 kW	150 kVA / 105 kW

Batteries

End of Discharge Voltage

The voltage is 1.6 to 1.75 per cell depending on discharge ratio.

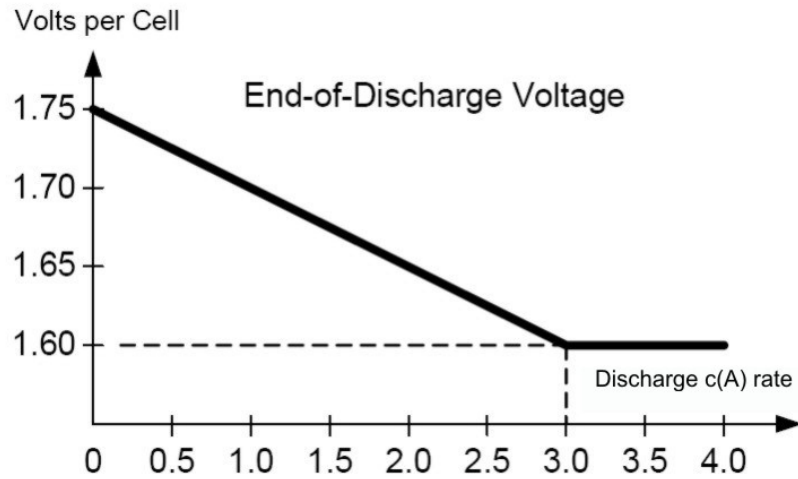

Standard VRLA Voltage Levels

Standard VRLA Voltage Levels
(at nominal temperature)

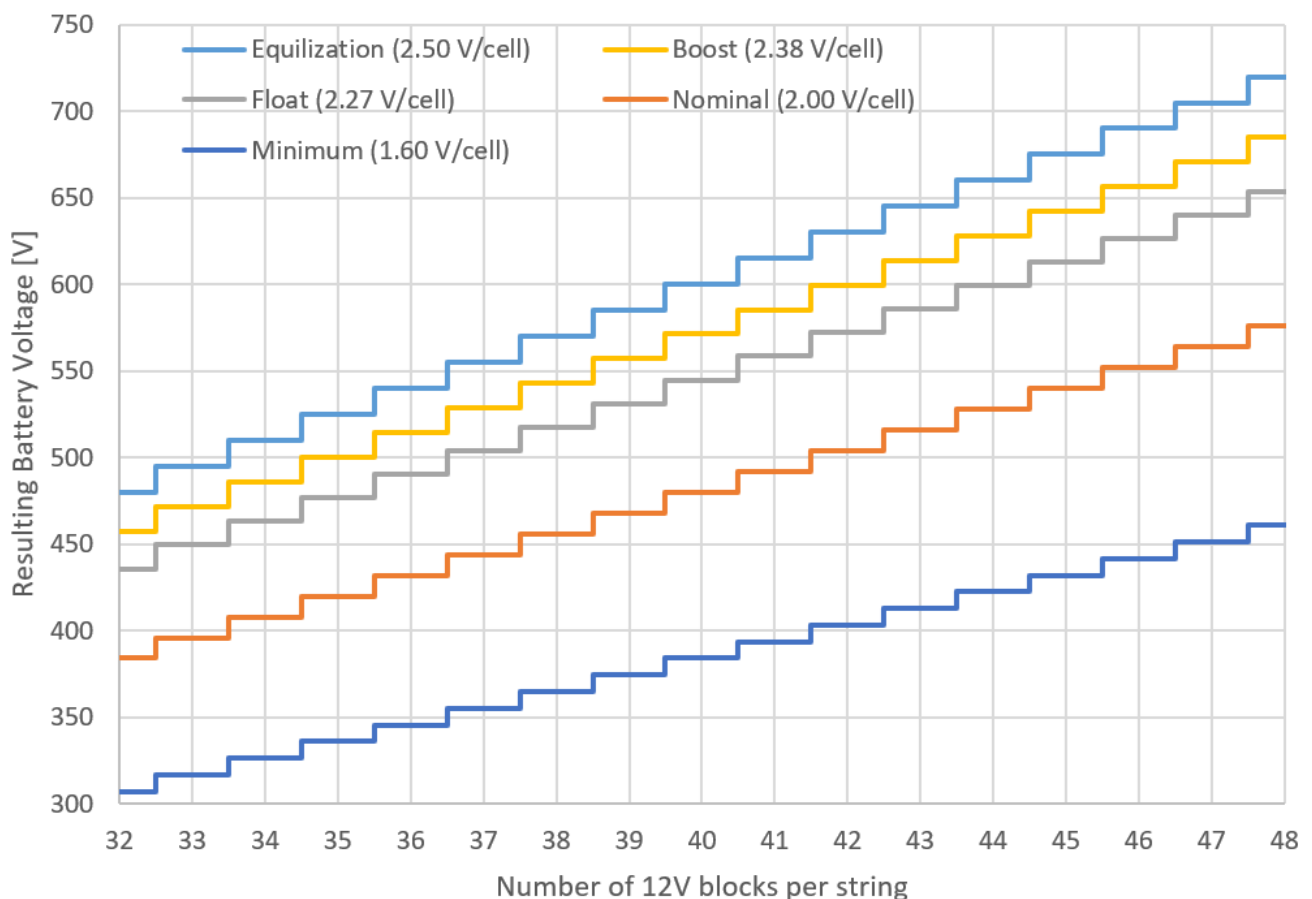

NOTE: Specific configurations may differ from the general constraint shown above.

Compliance

Safety	IEC 62040-1: 2017, Edition 2.0, Uninterruptible Power Systems (UPS) - Part 1: Safety requirements UL 1778 5th edition
EMC/EMI/RFI	IEC 62040-2: 2016, 3rd edition Uninterruptible Power Systems (UPS) - Part 2: Electromagnetic compatibility (EMC) requirements C2 FCC Part 15 Subpart B, Class A IEEE C62.41-1991 Location Category B1, IEEE Recommended Practice on Surge Voltages in Low-Voltage AC Power Circuits
Transportation	IEC 60721-4-2 Level 2M2
Seismic	ICC-ES AC 156 (2015); OSHPD Pre-approved; Sds=1.45 g for z/h=1 and Sds=2.00 g for z/h=0; Ip=1.5
Earthing system	TN-C, TN-S, TT, IT
Overvoltage category	This UPS is OVCII compliant. If the UPS is installed in an environment with an OVC rating higher than II, an SPD (surge protection device) must be installed upstream of the UPS to reduce the overvoltage category to OVCII.
Protective class	I
Pollution degree	2
Emergency Lighting and Power Equipment	UL 924 10th edition and CSA 22.2 NO. 141-15 5th edition

Performance

Performance in accordance with: IEC 62040-3: 2021, 3rd edition Uninterruptible Power Systems (UPS) - Part 3: Method of specifying the performance and test requirements.

Regional Seismic Compliance

Certificate available upon request.

Country/Region	Code ID	Hazard level ground	Hazard level roof
Argentina	INPRES-CIRSOC103	Zone 4	Zone 4
Australia	AS 1170.4-2007	Z = 0.22	Z = 0.22
Canada ¹	2020 NBCC	S _a = 2.0	S _a = 1.46
Chile	NCh 433.Of1996	Zone 3	Zone 2
China	GB 50011-2010 (2016)	α _{Max} = 1.4	α _{Max} = 1.2
Europe	Eurocode 8 EN1998-1	α _{gR} = 0.45	α _{gR} = 0.3
India	IS 1893 (Part 1) : 2016	Z = 0.36	Z = 0.36
Japan	Building Standard Law	Zone A	Zone A
New Zealand	NZS 1170.5:2004+A1	Z = 0.6	Z = 0.42
Peru	N.T.E. - E.030	Zone 4	Zone 4
Russia	SNIP II-7-81 (SP 14.13330.2014)	MSK 10	MSK 9
Taiwan	CPA 2011 Seismic Design Code	S _s ^D = 0.8	S _s ^D = 0.8
U.S.A. ¹	ASCE 7-16 / IBC 2018	S _{DS} = 2.0	S _{DS} = 1.47

1. OSHPD Pre-approved in accordance with AC156 test protocol.

Communication and Management

Local area network	1 Gbps – 1 port as default
Modbus	Modbus (SCADA)
Output relays	4 x SELV configurable
Input contacts	4 x SELV configurable
Standard control panel	4.3 inch touchscreen display
Audible alarm	Yes
Emergency Power Off (EPO)	Options: <ul style="list-style-type: none"> • Normally Open (NO) • Normally Closed (NC) • External 24 VDC SELV
External switchgear	UIB UOB SSIB MBB SIB
External synchronization	No
Battery monitoring	Available for external battery solutions

EPO

EPO Configurations (640–4864 terminal J6600, 1–9)

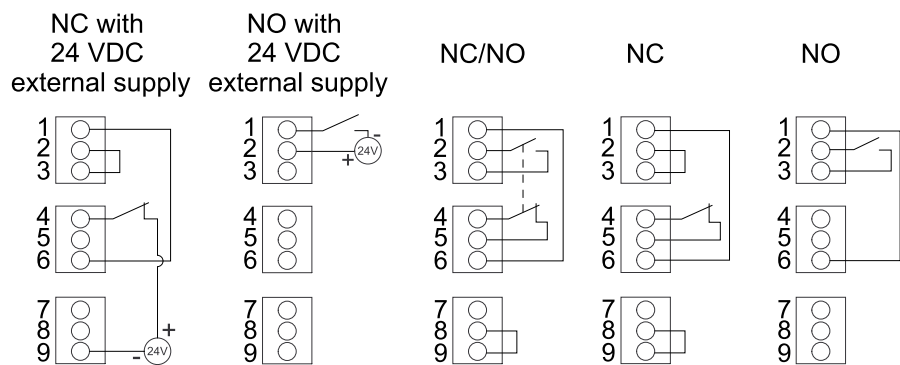

The EPO input supports 24 VDC.

NOTE: The default setting for the EPO activation is to turn off the inverter.

If you want the EPO activation to transfer the UPS into forced static bypass operation instead, please contact Schneider Electric.

Configurable Input Contacts and Output Relays

Input Contacts

Four input contacts are available and can be configured to indicate a given event via the display. The input contacts support 24 VDC 10 mA.

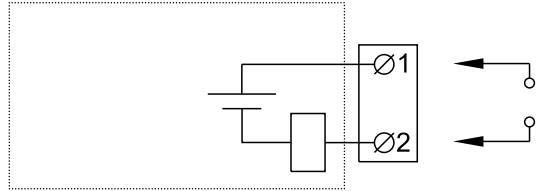

Name	Description	Location
IN _1 (input contact 1)	Configurable input contact	640-4864 terminal J6616, 1–2
IN _2 (input contact 2)	Configurable input contact	640-4864 terminal J6616, 3–4
IN _3 (input contact 3)	Configurable input contact	640-4864 terminal J6616, 5–6
IN _4 (input contact 4)	Configurable input contact	640-4864 terminal J6616, 7–8

Output Relays

Four output relays are available and can be configured to activate on one or more events via the display.

The output relays support 24 VAC/VDC 1 A. All external circuitry must be fused with maximum 1 A fast acting fuses.

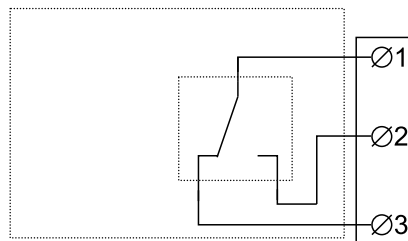

Name	Description	Location
OUT _1 (output relay 1)	Configurable output relay	640-4864 terminal J6617, 1–3
OUT _2 (output relay 2)	Configurable output relay	640-4864 terminal J6617, 4–6
OUT _3 (output relay 3)	Configurable output relay	640-4864 terminal J6617, 7–9
OUT _4 (output relay 4)	Configurable output relay	640-4864 terminal J6617, 10–12

Energized check mode: When this mode is enabled, it means that the output relay is activated when the events associated with the output relay are not present (normally activated). **Energized check mode** is individually set for each output relay and makes it possible to detect if the power supply to the output relays is lost, as all output relays will deactivate and the events associated with the output relays will be indicated as present.

Requirements for a Third Party Battery Solution

Battery breaker boxes from Schneider Electric are recommended for the battery interface. Please contact Schneider Electric for more information.

Third Party Battery Breaker Requirements

 **DANGER**

HAZARD OF ELECTRIC SHOCK, EXPLOSION, OR ARC FLASH

All selected battery breakers must be equipped with instantaneous trip functionality with an undervoltage release coil or a shunt trip release coil.

Failure to follow these instructions will result in death or serious injury.

NOTE: There are more factors to consider when selecting a battery breaker than the requirements listed below. Please contact Schneider Electric for more information.

Design Requirements for Battery Breaker

Battery breaker rated DC voltage > Normal battery voltage	The normal voltage of the battery configuration is defined as the highest nominal occurring battery voltage. This can be equivalent to the float voltage which may be defined as number of battery blocks x number of cells x cell float voltage .
Battery breaker rated DC current > Rated discharge battery current	This current is controlled by the UPS and must include maximum discharge current. This will typically be the current at the end of discharge (minimum operation DC voltage or in overload condition or a combination).
DC landings	Two DC landings for DC cables are required.
AUX switches for monitoring	One AUX switch must be installed in each battery breaker and connected to the UPS. The UPS can monitor up to two battery breakers.
Short-circuit breaking capability	The short-circuit breaking capability must be higher than the short-circuit DC current of the (largest) battery configuration.
Minimum trip current	The minimum short-circuit current to trip the battery breaker must match the (smallest) battery configuration, to make the breaker trip in case of a short circuit, up to the end of its life time.

Guidance for Organizing Battery Cables

NOTE: For 3rd party batteries, use only high rate batteries for UPS applications.

NOTE: When the battery bank is placed remotely, the organizing of the cables is important to reduce voltage drop and inductance. The distance between the battery bank and the UPS must not exceed 200 m (656 ft). Contact Schneider Electric for installations with a longer distance.

NOTE: To minimize the risk of electromagnetic radiation, it is highly recommended to follow the below guidance and to use grounded metallic tray supports.

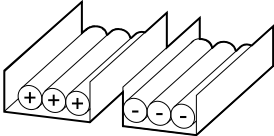
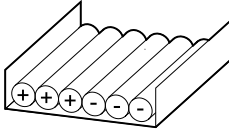
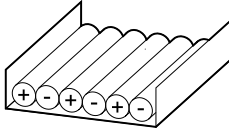
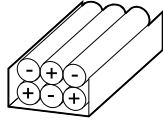
Cable Length				
<30 m	Not recommended	Acceptable	Recommended	Recommended
31–75 m	Not recommended	Not recommended	Acceptable	Recommended
76–150 m	Not recommended	Not recommended	Acceptable	Recommended
151–200 m	Not recommended	Not recommended	Not recommended	Recommended

Specifications for 480 V Systems

The supply for input and bypass must be solid-grounded WYE transformers. Delta input supply for either input or bypass is not permitted.

The UPS system must be installed as a separately derived system. Leakage currents will occur in the bonding jumper and the technical/system earth.

Input Specifications 480 V

UPS rating	20 kW	30 kW	40 kW	50 kW	60 kW	80 kW	100 kW	120 kW	150 kW
Connections	3-wire (L1, L2, L3, G) WYE or 4-wire (L1, L2, L3, N, G) WYE (single mains) 3-wire (L1, L2, L3, G) WYE (dual mains)								
Input voltage range (V)	408-552								
Frequency range (Hz)	40-70								
Nominal input current (A)	25	37	50	62	74	99	124	149	186
Maximum input current (A)	31	46	61	75	91	121	152	182	227
Input current limitation (A)	31	48	63	77	95	126	154	188	231
Input power factor	0.99 for load greater than 50% 0.95 for load greater than 25%								
Total harmonic distortion (THDI)	<5% at 100% load			<3% at 100% load	<5% at 100% load		<3% at 100% load	<5% at 100% load	<3% at 100% load
Maximum short circuit rating	65 kA RMS								
Protection	Built-in backfeed protection and fuses								
Ramp-in	Programmable and adaptive 1-40 seconds								

NOTE: For a UPS with N+1 power module, the input power factor is 0.99 at 100% load and the total harmonic distortion (THDI) is <6% at full linear load (symmetrical).

Bypass Specifications 480 V

UPS rating	20 kW	30 kW	40 kW	50 kW	60 kW	80 kW	100 kW	120 kW	150 kW
Connections	3-wire (L1, L2, L3, G) WYE or 4-wire (L1, L2, L3, N, G) WYE								
Bypass voltage range (V)	432-528								
Frequency range (Hz)	50/60 ± 1, 50/60 ± 3, 50/60 ± 10 (user selectable)								
Nominal bypass current (A)	25	37	50	62	74	99	123	148	185
Nominal neutral current (A) ²	42	62	83	104	125	166	208	208	208
Maximum short circuit rating	65 kA RMS								
Protection	Built-in backfeed protection and fuses Internal fuse specifications: Rated 400 A, prearcing 33 kA ² s							Built-in backfeed protection and fuses Internal fuse specifications: Rated 550 A, prearcing 52 kA ² s	

2. Harmonic currents in neutral are only considered to be 1.73 x nominal up till 100 kW. Above 100 kW only resistive load is considered.

Output Specifications 480 V

NOTE: The number of output connections must match the number of input wires in a single mains system or bypass wires in a dual mains system.

UPS rating	20 kW	30 kW	40 kW	50 kW	60 kW	80 kW	100 kW	120 kW	150 kW
Connections	3-wire (L1, L2, L3, G, GEC ³) or 4-wire (L1, L2, L3, N, G)								
Output voltage regulation	Symmetrical load $\pm 1\%$ Asymmetrical load $\pm 3\%$								
Overload capacity	150% for 1 minute (in normal operation) 125% for 10 minutes (in normal operation) 125% for 1 minute (in battery operation) 125% continuous (bypass operation) 1000% for 100 milliseconds (bypass operation)								
Dynamic load response	$\pm 5\%$ after 2 milliseconds $\pm 1\%$ after 50 milliseconds								
Output power factor	1								
Nominal output current (A)	24	36	48	60	72	96	120	144	180
Frequency regulation (Hz)	50/60 Hz bypass synchronized – 50/60 Hz $\pm 0.1\%$ free-running								
Synchronized slew rate (Hz/sec)	Programmable to 0.25, 0.5, 1, 2, 4, 6								
Total harmonic distortion (THDU)	<1% for linear load <5% for non-linear load								
Load crest factor	2.5								
Load power factor	From 0.7 leading to 0.7 lagging without any derating								

3. Per NEC 250.30.

Battery Specifications 480 V

DANGER

HAZARD OF ELECTRIC SHOCK, EXPLOSION, OR ARC FLASH

- Protection of the energy storage device: An overcurrent protective device must be located in close proximity to the energy storage device.
- Trip delay must be set to zero on all battery breakers.

Failure to follow these instructions will result in death or serious injury.

UPS rating	20 kW	30 kW	40 kW	50 kW	60 kW	80 kW	100 kW	120 kW	150 kW
Charging power in % of output power at 0-40% load ⁴	80%								
Charging power in % of output power at 100% load	20%								
Maximum charging power (at 0-40% load) (kW) ⁴	16	24	32	40	48	64	80	96	120
Maximum charging power (at 100% load) (kW)	4	6	8	10	12	16	20	24	30
Nominal battery voltage (VDC)	32-48 blocks: 384-576			40-48 blocks: 480-576	35-48 blocks: 420-576	32-48 blocks: 384-576	40-48 blocks: 480-576		
Nominal float voltage (VDC)	32-48 blocks: 436-654			40-48 blocks: 545-654	35-48 blocks: 477-654	32-48 blocks: 436-654	40-48 blocks: 545-654		
Maximum boost voltage (VDC)	720 for 48 blocks								
Temperature compensation (per cell)	-3.3mV/°C, for T ≥ 25 °C – 0mV/°C, for T < 25 °C								
End of discharge voltage (full load) (VDC)	32 blocks: 307			40 blocks: 384	35 blocks: 336	32 blocks: 307	40 blocks: 384		
Battery current at full load and nominal battery voltage (A) ⁵	54	81	108	108	130	173	216	260	326
Battery current at full load and minimum battery voltage (A) ⁵	68	101	135	135	162	216	270	325	406
Ripple current	< 5% C20 (5 minute runtime)								
Battery test	Manual/automatic (selectable)								
Maximum short circuit rating	10 kA								

NOTE: For a 60 kW UPS with N+1 power module, the supported battery block quantity is 32-48 blocks.

4. Values based on 48 blocks.
 5. Values based on 20-40 kW: 32 blocks; 50-150 kW: 40 blocks.

Recommended Cable Sizes 480 V



HAZARD OF ELECTRIC SHOCK, EXPLOSION, OR ARC FLASH

All wiring must comply with all applicable national and/or electrical codes. The maximum allowable cable size is 300 kcmil.

Failure to follow these instructions will result in death or serious injury.

The maximum number of cable connections per busbar: Two on input/output/ bypass busbars; Four on DC+/DC- busbars; Six on N/G busbars.

NOTE: Overcurrent protection is to be provided by others.

Cable sizes in this manual are based on Table 310.15 (B)(16) of the National Electrical Code (NEC) with the following assertions:

- 90 °C (194 °F) conductors (75 °C (167 °F) termination)
- An ambient temperature of 30 °C (86 °F)
- Use of copper or aluminum conductors

Equipment grounding conductors (EGC) are sized in accordance with NEC Article 250.122 and Table 250.122.

If the ambient temperature is greater than 30 °C (86 °F), larger conductors are to be selected in accordance with the correction factors of the NEC.

NOTE: For the scalable UPS (GVSUPS50K150GS), always size the cables for a UPS rating of 150 kW.

NOTE: Recommended cable sizes and maximum allowable cable size may vary for the auxiliary products. Not all auxiliary products support aluminum cables. Refer to the installation manual provided with the auxiliary product.

NOTE: The DC cable sizes given here are recommendations – Always follow the specific instructions in the battery solution documentation for DC cable sizes and DC EGC cable sizes and ensure that the DC cable sizes match the battery breaker rating.

NOTE: Neutral conductor is sized to handle 1.73 times phase current in case of high harmonic content from non-linear loads. If non or less harmonic currents are expected, neutral conductor can be sized accordingly but not less than the phase conductor.

NOTE: 20-40 kW: DC cables are sized according to 32 battery blocks. 50-100 kW: DC cables are sized according to 40 battery blocks.

Copper

UPS rating	20 kW	30 kW	40 kW	50 kW	60 kW	80 kW	100 kW	120 kW	150 kW
Input phases (AWG/ kcmil)	8	6	4	3	1	2/0	3/0	4/0	300
Input EGC (AWG/ kcmil)	10	8	8	6	6	6	4	4	4
Bypass/output phases (AWG/kcmil)	10	8	6	4	3	1	2/0	3/0	4/0
Bypass EGC/output EGC (AWG/kcmil)	10	10	8	8	8	6	6	6	4
Neutral (AWG/kcmil)	6	4	2	1/0	2/0	4/0	2 x 1/0	2 x 1/0	2 x 1/0
DC+/DC-(AWG/ kcmil)	4	2	1/0	1/0	2/0	4/0	2 x 1/0	2 x 3/0	2 x 4/0
DC EGC (AWG/ kcmil)	8	6	6	6	6	4	4	3	2

Aluminum

UPS rating	20 kW	30 kW	40 kW	50 kW	60 kW	80 kW	100 kW	120 kW	150 kW
Input phases (AWG/kcmil)	6	4	2	1	1/0	3/0	250	300	2 x 3/0
Input EGC (AWG/kcmil)	6	6	6	4	4	4	2	2	2 x 2
Bypass/output phases (AWG/kcmil)	6	6	4	2	1	2/0	3/0	250	300
Bypass EGC/output EGC (AWG/kcmil)	6	6	6	6	6	4	4	4	2
Neutral (AWG/kcmil)	4	2	1/0	2/0	4/0	2 x 1/0	2 x 2/0	2 x 250	2 x 2/0
DC+/DC-(AWG/kcmil)	3	1/0	2/0	2/0	4/0	2 x 1/0	2 x 3/0	1	2 x 250
DC EGC (AWG/kcmil)	6	4	4	4	4	2	2	2 x 1	2 x 1/0

NOTE: For DC EGC aluminum cables used in parallel conduits, EGC must be full-sized in order to prevent overload or burnout of cables.

NOTE: 80% rated circuit breakers for UIB, UOB, MBB, SSIB.

Recommended Upstream Protection 480 V

⚡ ⚠ DANGER

HAZARD OF ELECTRIC SHOCK, EXPLOSION, OR ARC FLASH

- For parallel systems, instantaneous override (li) values must not be set higher than 1250 A. Place the label 885-92556 adjacent to the upstream circuit breaker to inform about the hazard.
- For UPS rating 20-120 kW: In parallel systems with three or more UPSs, a circuit breaker must be installed on the output of each UPS. The unit output breaker (UOB) instantaneous override (li) values must not be set higher than 1250 A.
- For UPS rating 150 kW: In parallel systems with two or more UPSs, a circuit breaker must be installed on the output of each UPS. The unit output breaker (UOB) instantaneous override (li) values must not be set higher than 1250 A.

Failure to follow these instructions will result in death or serious injury.

⚠ CAUTION

HAZARD OF FIRE

- Connect only to a circuit with the below specifications.
- Connect to a circuit provided with a 250 A branch circuit overcurrent protection maximum in accordance with the National Electrical Code, ANSI/NFPA70, and the Canadian Electrical Code, Part I, C22.1.

Failure to follow these instructions can result in injury or equipment damage.

NOTE: For the scalable UPS (GVSUPS50K150GS), always size the upstream protection for a UPS rating of 150 kW.

NOTE: Overcurrent protection is to be provided by others and marked with its function.

NOTE: Circuit breakers listed below are 80% rated.

UPS rating	20 kW		30 kW		40 kW		50 kW	
	Input	Bypass	Input	Bypass	Input	Bypass	Input	Bypass
Breaker type	HJF36100U31X							
I _r	40	35	60	50	80	70	100	80
tr @ 6 I _r	0.5-16							
li (x I _n)	≤8							

UPS rating	60 kW		80 kW		100 kW	
	Input	Bypass	Input	Bypass	Input	Bypass
Breaker type	HJF36150U31X	HJF36100U31X	JJF36250U31X	HJF36150U31X	JJF36250U31X	
I _r	125	100	175	125	200	175
tr @ 6 I _r	0.5-16					
li (x I _n)	≤10	≤12	≤5	≤8	≤5	

UPS rating	120 kW		150 kW	
	Input	Bypass	Input	Bypass
Breaker type	JJF36250U31X	JJF36250U31X	LJF36400U31X	JJF36250U31X
I _r	250	200	300	250

UPS rating	120 kW		150 kW	
	Input	Bypass	Input	Bypass
tr @ 6 lr	0.5-16			
li (x ln)	≤5		≤3	≤5

Specifications for 208 V Systems

Input Specifications 208 V

UPS rating	10 kW	15 kW	20 kW	25 kW	30 kW	40 kW	50 kW	60 kW	75 kW	
Voltage (V)	200/208/220									
Connections	4-wire (L1, L2, L3, N, G) WYE (single mains) 3-wire (L1, L2, L3, G) WYE (dual mains)									
Input voltage range (V)	200 V: 170-230 208 V: 177-239 220 V: 187-253									
Frequency range (Hz)	40-70									
Nominal input current (A)	31/30/28	47/45/42	62/60/56	78/75/71	93/90/85	124/119/113	155/149/141	186/179/169	233/224/212	
Maximum input current (A)	38/37/35	57/55/52	75/73/69	93/92/86	114/109/104	152/145/137	185/182/172	227/219/206	278/274/258	
Input current limitation (A)	40/38/36	59/56/53	78/75/71	93/92/86	117/111/106	156/149/141	185/182/172	233/224/211	278/274/258	
Input power factor	0.99 for load greater than 50% 0.95 for load greater than 25%									
Total harmonic distortion (THDI)	<5% at 100% load	<3% at 100% load						<5% at 100% load	<3% at 100% load	
Maximum short circuit rating	65 kA RMS									
Protection	Built-in backfeed protection and fuses									
Ramp-in	Programmable and adaptive 1-40 seconds									

NOTE: For a UPS with N+1 power module, the input power factor is 0.99 at 100% load and the total harmonic distortion (THDI) is <6% at full linear load (symmetrical).

Bypass Specifications 208 V

UPS rating	10 kW	15 kW	20 kW	25 kW	30 kW	40 kW	50 kW	60 kW	75 kW
Voltage (V)	200/208/220								
Connections	4-wire (L1, L2, L3, N, G) WYE								
Bypass voltage range (V)	200 V: 180-220 208 V: 187-229 220 V: 198-242								
Frequency range (Hz)	50/60 ± 1, 50/60 ± 3, 50/60 ± 10 (user selectable)								
Nominal bypass current (A)	30/29/28	45/43/41	59/57/54	74/71/67	88/85/81	119/114/108	148/142/135	178/171/162	223/214/202
Nominal neutral current (A) ⁶	50/48/45	75/72/68	100/96/91	125/120/114	150/144/136	200/192/182	250/240/227	250/240/227	250/240/227

6. Harmonic currents in neutral are only considered to be 1.73 x nominal up till 50 kW. Above 50 kW only resistive load is considered.

UPS rating	10 kW	15 kW	20 kW	25 kW	30 kW	40 kW	50 kW	60 kW	75 kW
Voltage (V)	200/208/220								
Maximum short circuit rating	65 kA RMS								
Protection	Built-in backfeed protection and fuses Internal fuse specifications: Rated 400 A, prearcing 33 kA ² s							Built-in backfeed protection and fuses Internal fuse specifications: Rated 550 A, prearcing 52 kA ² s	

Output Specifications 208 V

UPS rating	10 kW	15 kW	20 kW	25 kW	30 kW	40 kW	50 kW	60 kW	75 kW
Voltage (V)	200/208/220								
Connections	4-wire (L1, L2, L3, N, G)								
Output voltage regulation	Symmetrical load ± 1% Asymmetrical load ± 3%								
Overload capacity	150% for 1 minute (in normal operation) 125% for 10 minutes (in normal operation) 125% for 1 minute (in battery operation) 125% continuous (bypass operation) 1000% for 100 milliseconds (bypass operation)								
Dynamic load response	± 5% after 2 milliseconds ± 1% after 50 milliseconds								
Output power factor	1								
Nominal output current (A)	29/28/26	43/42/39	58/56/52	73/70/66	87/83/79	115/111/105	144/139/131	173/167/157	217/208/197
Frequency regulation (Hz)	50/60 Hz bypass synchronized – 50/60 Hz ± 0.1% free-running								
Synchronized slew rate (Hz/sec)	Programmable to 0.25, 0.5, 1, 2, 4, 6								
Total harmonic distortion (THDU)	<2%								
Load crest factor	2.5								
Load power factor	From 0.7 leading to 0.7 lagging without any derating								

Battery Specifications 208 V

DANGER

HAZARD OF ELECTRIC SHOCK, EXPLOSION, OR ARC FLASH

- Protection of the energy storage device: An overcurrent protective device must be located in close proximity to the energy storage device.
- Trip delay must be set to zero on all battery breakers.

Failure to follow these instructions will result in death or serious injury.

UPS rating	10 kW	15 kW	20 kW	25 kW	30 kW	40 kW	50 kW	60 kW	75 kW
Charging power in % of output power at 0-40% load ⁷	80%								
Charging power in % of output power at 100% load	20%								
Maximum charging power (at 0-40% load) (kW) ⁷	8	12	16	20	24	32	40	48	60
Maximum charging power (at 100% load) (kW)	2	3	4	5	6	8	10	12	15
Nominal battery voltage (VDC)	32-40 blocks: 384-480								
Nominal float voltage (VDC)	32-40 blocks: 436-545								
Maximum boost voltage (VDC)	600 for 40 blocks								
Temperature compensation (per cell)	-3.3mV/°C, for T ≥ 25 °C – 0mV/°C, for T < 25 °C								
End of discharge voltage (full load) (VDC)	32 blocks: 307								
Battery current at full load and nominal battery voltage (A) ⁸	27	41	55	68	82	109	136	164	205
Battery current at full load and minimum battery voltage (A) ⁸	34	51	68	85	102	136	170	204	254
Ripple current	< 5% C20 (5 minute runtime)								
Battery test	Manual/automatic (selectable)								
Maximum short circuit rating	10 kA								

7. Values based on 40 blocks.
 8. Values based on 32 blocks.

Recommended Cable Sizes 208 V

⚠️⚠️ DANGER

HAZARD OF ELECTRIC SHOCK, EXPLOSION, OR ARC FLASH

All wiring must comply with all applicable national and/or electrical codes. The maximum allowable cable size is 300 kcmil.

Failure to follow these instructions will result in death or serious injury.

The maximum number of cable connections per busbar: Two on input/output/ bypass busbars; Four on DC+/DC- busbars; Six on N/G busbars.

NOTE: Overcurrent protection is to be provided by others.

Cable sizes in this manual are based on Table 310.15 (B)(16) of the National Electrical Code (NEC) with the following assertions:

- 90 °C (194 °F) conductors (75 °C (167 °F) termination)
- An ambient temperature of 30 °C (86 °F)
- Use of copper or aluminum conductors

If the ambient temperature is greater than 30 °C (86 °F), larger conductors are to be selected in accordance with the correction factors of the NEC.

Equipment grounding conductors (EGC) are sized in accordance with NEC Article 250.122 and Table 250.122.

NOTE: For the scalable UPS (GVSUPS25K75FS), always size the cables for a UPS rating of 75 kW.

NOTE: Recommended cable sizes and maximum allowable cable size may vary for the auxiliary products. Not all auxiliary products support aluminum cables. Refer to the installation manual provided with the auxiliary product.

NOTE: The DC cable sizes given here are recommendations – Always follow the specific instructions in the battery solution documentation for DC cable sizes and DC EGC cable sizes and ensure that the DC cable sizes match the battery breaker rating.

NOTE: Neutral conductor is sized to handle 1.73 times phase current in case of high harmonic content from non-linear loads. If non or less harmonic currents are expected, neutral conductor can be sized accordingly but not less than the phase conductor.

Copper

UPS rating	10 kW	15 kW	20 kW	25 kW	30 kW	40 kW	50 kW	60 kW	75 kW
Input phases (AWG/kcmil)	8	4	3	2	1/0	3/0	4/0	300	2 x 2/0
Input EGC (AWG/kcmil)	10	8	8	6	6	6	4	4	3
Bypass/output phases (AWG/kcmil)	8	6	4	3	2	1/0	3/0	4/0	300
Bypass EGC/output EGC (AWG/kcmil)	10	10	8	8	6	6	6	4	4
Neutral (AWG/kcmil)	6	3	1	2/0	3/0	2 x 1/0	2 x 2/0	2 x 2/0	2 x 2/0
DC+/DC-(AWG/kcmil)	10	6	4	4	2	1/0	2/0	4/0	250
DC EGC (AWG/kcmil)	10	10	8	8	6	6	6	4	4

Aluminum

UPS rating	10 kW	15 kW	20 kW	25 kW	30 kW	40 kW	50 kW	60 kW	75 kW
Input phases (AWG/kcmil)	6	3	1	1/0	3/0	250	300	2 x 3/0	4/0
Input EGC (AWG/kcmil)	6	6	6	4	4	4	2	2 x 2	1
Bypass/output phases (AWG/kcmil)	6	4	3	1	1/0	3/0	250	300	2 x 3/0
Bypass EGC/output EGC (AWG/kcmil)	6	6	6	6	4	4	4	2	2
Neutral (AWG/kcmil)	4	1	2/0	4/0	2 x 1/0	2 x 2/0	2 x 4/0	2 x 4/0	2 x 4/0
DC+/DC-(AWG/kcmil)	8	4	3	2	1/0	3/0	4/0	250	2 x 3/0
DC EGC (AWG/kcmil)	6	6	6	6	4	4	4	2	2

NOTE: For DC EGC aluminum cables used in parallel conduits, EGC must be full-sized in order to prevent overload or burnout of cables.

NOTE: 80% rated circuit breakers for UIB, UOB, MBB, SSIB.

Recommended Upstream Protection 208 V

⚠️⚠️ DANGER

HAZARD OF ELECTRIC SHOCK, EXPLOSION, OR ARC FLASH

- For parallel systems, instantaneous override (li) values must not be set higher than 1250 A. Place the label 885-92556 adjacent to the upstream circuit breaker to inform about the hazard.
- For UPS rating 10-60 kW: In parallel systems with three or more UPSs, a circuit breaker must be installed on the output of each UPS. The unit output breaker (UOB) instantaneous override (li) values must not be set higher than 1250 A.
- For UPS rating 75 kW: In parallel systems with two or more UPSs, a circuit breaker must be installed on the output of each UPS. The unit output breaker (UOB) instantaneous override (li) values must not be set higher than 1250 A.

Failure to follow these instructions will result in death or serious injury.

⚠️ CAUTION

HAZARD OF FIRE

- Connect only to a circuit with the below specifications.
- Connect to a circuit provided with a 250 A branch circuit overcurrent protection maximum in accordance with the National Electrical Code, ANSI/NFPA70, and the Canadian Electrical Code, Part I, C22.1.

Failure to follow these instructions can result in injury or equipment damage.

NOTE: For the scalable UPS (GVSUPS25K75FS), always size the upstream protection for a UPS rating of 75 kW.

NOTE: Overcurrent protection is to be provided by others and marked with its function.

UPS rating	10 kW		15 kW		20 kW		25 kW	
	Input	Bypass	Input	Bypass	Input	Bypass	Input	Bypass
Breaker type	HJF36100U31X						HJF36150-U31X	HJF36100-U31X
Ir	50	40	80	60	100	80	125	100
tr @ 6 Ir	0.5-16							
li (x In)	≤8						≤5	≤8

UPS rating	30 kW		40 kW		50 kW	
	Input	Bypass	Input	Bypass	Input	Bypass
Breaker type	HJF36150U31X		JJF36250U31X	HJF36150U31X	JJF36250U31X	
Ir	150	110	200	150	250	200
tr @ 6 Ir	0.5-16					
li (x In)	≤10	≤12	≤5	≤8	≤5	

UPS rating	60 kW		75 kW	
	Input	Bypass	Input	Bypass
Breaker type	LJF36400U31X	JJF36250U31X	LJF36400U31X	LJF36400U31X
Ir	300	225	350	300

UPS rating	60 kW		75 kW	
	Input	Bypass	Input	Bypass
tr @ 6 Ir	0.5-16			
li (x In)	≤5		≤3	≤5

Recommended Bolt and Lug Sizes for UL

NOTICE

RISK OF EQUIPMENT DAMAGE

Use only UL approved compression cable lugs.

Failure to follow these instructions can result in equipment damage.

Copper — One Hole Cable Lugs

Cable size	Bolt size	Cable lug type	Crimping tool	Die
10 AWG	M8 x 25 mm	LCA10-56-L	NA	NA
8 AWG	M8 x 25 mm	LCA8-56-L	CT-720	CD-720-1 Red P21
6 AWG	M8 x 25 mm	LCA6-56-L	CT-720	CD-720-1 Blue P24
4 AWG	M8 x 25 mm	LCA4-56-L	CT-720	CD-720-1 Gray P29
3 AWG	M8 x 25 mm	LCA4-56-L	CT-720	CD-720-1 Gray P29
2 AWG	M8 x 25 mm	LCA2-56-Q	CT-720	CD-720-1 Brown P33
1 AWG	M8 x 25 mm	LCA1-56-E	CT-720	CD-720-2 Green P37
1/0 AWG	M8 x 25 mm	LCA1/0-56-X	CT-720	CD-720-2 Pink P42
2/0 AWG	M8 x 25 mm	LCA2/0-56-X	CT-720	CD-720-2 Black P45
3/0 AWG	M8 x 25 mm	LCA3/0-56-X	CT-720	CD-720-2 Orange P50
4/0 AWG	M8 x 25 mm	LCA4/0-56-X	CT-720	CD-720-3 Purple P54
250 kcmil	M8 x 25 mm	LCA250-56-X	CT-720	CD-720-3 Yellow P62
300 kcmil	M8 x 25 mm	LCA300-56-X	CT-720	CD-720-4 White P66

Copper — Two Hole Cable Lugs

Cable size	Bolt size	Cable lug type	Crimping tool	Die
6 AWG	M8 x 25 mm	LCC6-12-L	CT-930	CD-920-6 Blue P24
4 AWG	M8 x 25 mm	LCC4-12-L	CT-930	CD-920-4 Gray P29
3 AWG	M8 x 25 mm			
2 AWG	M8 x 25 mm	LCC2-12-Q	CT-930	CD-920-2 Brown P33
1 AWG	M8 x 25 mm	LCC1-12-E	CT-930	CD-920-1 Green P37
1/0 AWG	M8 x 25 mm	LCC1/0-12-X	CT-930	CD-920-1/0 Pink P42
2/0 AWG	M8 x 25 mm	LCC2/0-12-X	CT-930	CD-920-2/0 Black P45
3/0 AWG	M8 x 25 mm	LCC3/0-12-X	CT-930	CD-920-3/0 Orange P50
4/0 AWG	M8 x 25 mm	LCC4/0-12-X	CT-930	CD-920-4/0 Purple P54
250 kcmil	M8 x 25 mm	LCC250-12-X	CT-930	CD-920-250 Yellow P62
300 kcmil	M8 x 25 mm	LCC300-12-X	CT-930	CD-920-300 White P66

Aluminum — One Hole Cable Lugs

Cable size	Bolt size	Cable lug type	Crimping tool	Die
6 AWG	M8 x 25 mm	LAA6-56-X	CT-720	CD-720-1 Gray P29
4 AWG	M8 x 25 mm	LAA4-56-X	CT-720	CD-720-2 Green P37
3 AWG	M8 x 25 mm	LAA3-56-X	CT-720	CD-720-2 Green P37
2 AWG	M8 x 25 mm	LAA2-56-X	CT-720	CD-720-2 Pink P42
1 AWG	M8 x 25 mm	LAA1-56-X	CT-720	CD-720-2 Gold P45

Aluminum — One Hole Cable Lugs (Continued)

Cable size	Bolt size	Cable lug type	Crimping tool	Die
1/0 AWG	M8 x 25 mm	LAA1/0-56-X	CT-720	CD-720-2 Tan P50
2/0 AWG	M8 x 25 mm	LAA2/0-56-5	CT-720	CD-720-3 Olive P54
3/0 AWG	M8 x 25 mm	LAA3/0-56-5	CT-720	CD-720-3 Ruby P60
4/0 AWG	M8 x 25 mm	LAA4/0-56-5	CT-720	CD-720-4 White P66
250 kcmil	M8 x 25 mm	LAA250-56-5	CT-720	CD-720-5 Red P71
300 kcmil	M8 x 25 mm	LAA300-56-5	CT-720	CD-720-6 Blue P76

Aluminum — Two Hole Cable Lugs

Cable size	Bolt size	Cable lug type	Crimping tool	Die
2/0 AWG	M8 x 25 mm	LAB2/0-12-5	CT-720	CD-720-3 Olive P54
3/0 AWG	M8 x 25 mm	LAB3/0-12-5	CT-720	CD-720-3 Ruby P60
4/0 AWG	M8 x 25 mm	LAB4/0-12-5	CT-720	CD-720-4 White P66
250 kcmil	M8 x 25 mm	LAB250-12-2	CT-720	CD-720-5 Red P71
300 kcmil	M8 x 25 mm	LAB300-12-2	CT-720	CD-720-6 Blue P76

Torque Specifications

Bolt size	Torque
M4	1.7 Nm (1.25 lb-ft / 15 lb-in)
M5	2.2 Nm (1.62 lb-ft / 19.5 lb-in)
M6	5 Nm (3.69 lb-ft / 44.3 lb-in)
M8	17.5 Nm (12.91 lb-ft / 154.9 lb-in)
M10	30 Nm (22 lb-ft / 194.7 lb-in)
M12	50 Nm (36.87 lb-ft / 442.5 lb-in)

Physical

UPS Shipping Weights and Dimensions

	Weight kg (lbs)	Height mm (in)	Width mm (in)	Depth mm (in)
20-50 kW UPS 480 V	235 (518)	1680 (66.14)	640 (25.2)	990 (38.98)
20-50 kW UPS with N+1 power module 480 V	250 (551)	1680 (66.14)	640 (25.2)	990 (38.98)
60 kW UPS 480 V	263 (580)	1680 (66.14)	640 (25.2)	990 (38.98)
60-100 kW UPS with N+1 power module 480 V*	250 (551)	1680 (66.14)	640 (25.2)	990 (38.98)
80-100 kW UPS 480 V	275 (606)	1680 (66.14)	640 (25.2)	990 (38.98)
120 kW UPS 480 V*	250 (551)	1680 (66.14)	640 (25.2)	990 (38.98)
150 kW UPS 480 V*	250 (551)	1680 (66.14)	640 (25.2)	990 (38.98)
10-25 kW UPS 208 V	235 (518)	1680 (66.14)	640 (25.2)	990 (38.98)
10-25 kW UPS with N+1 power module 208 V	250 (551)	1680 (66.14)	640 (25.2)	990 (38.98)
30 kW UPS 208 V	263 (580)	1680 (66.14)	640 (25.2)	990 (38.98)
30-50 kW UPS with N+1 power module 208 V*	250 (551)	1680 (66.14)	640 (25.2)	990 (38.98)
40-50 kW UPS 208 V	275 (606)	1680 (66.14)	640 (25.2)	990 (38.98)
60 kW UPS 208 V*	250 (551)	1680 (66.14)	640 (25.2)	990 (38.98)
75 kW UPS 208 V*	250 (551)	1680 (66.14)	640 (25.2)	990 (38.98)

NOTE: The UPS models marked with an * in the table above are shipped with one power module preinstalled in the UPS and two power modules shipped separately.

Power Module Shipping Weights and Dimensions

Commercial reference	Weight kg (lbs)	Height mm (in)	Width mm (in)	Depth mm (in)
GVPM20KD	48 (106)	330 (12.99)	580 (22.83)	780 (30.70)
GVPM50KD	62 (137)	330 (12.99)	580 (22.83)	780 (30.70)

UPS Weights and Dimensions

	Weight kg (lbs)	Height mm (in)	Width mm (in)	Depth mm (in)
20-50 kW UPS 480 V	206 (454)	1485 (58.46)	521 (20.51)	847 (33.35)
20-50 kW UPS with N+1 power module 480 V	250 (551)	1485 (58.46)	521 (20.51)	847 (33.35)
60 kW UPS 480 V	238 (525)	1485 (58.46)	521 (20.51)	847 (33.35)
60-100 kW UPS with N +1 power module 480 V	290 (639)	1485 (58.46)	521 (20.51)	847 (33.35)
80-100 kW UPS 480 V	250 (551)	1485 (58.46)	521 (20.51)	847 (33.35)
120 kW UPS 480 V	278 (613)	1485 (58.46)	521 (20.51)	847 (33.35)
150 kW UPS 480 V	290 (639)	1485 (58.46)	521 (20.51)	847 (33.35)
10-25 kW UPS 208 V	206 (454)	1485 (58.46)	521 (20.51)	847 (33.35)
10-25 kW UPS with N+1 power module 208 V	250 (551)	1485 (58.46)	521 (20.51)	847 (33.35)
30 kW UPS 208 V	238 (525)	1485 (58.46)	521 (20.51)	847 (33.35)
30-50 kW UPS with N+1 power module 208 V	290 (639)	1485 (58.46)	521 (20.51)	847 (33.35)
40-50 kW UPS 208 V	250 (551)	1485 (58.46)	521 (20.51)	847 (33.35)
60 kW UPS 208 V	278 (613)	1485 (58.46)	521 (20.51)	847 (33.35)
75 kW UPS 208 V	290 (639)	1485 (58.46)	521 (20.51)	847 (33.35)

Clearance

NOTE: Clearance dimensions are published for airflow and service access only. Consult with the local safety codes and standards for additional requirements in your local area.

NOTE: The required minimum rear clearance is 150 mm (5.91 in).

Front View of the UPS

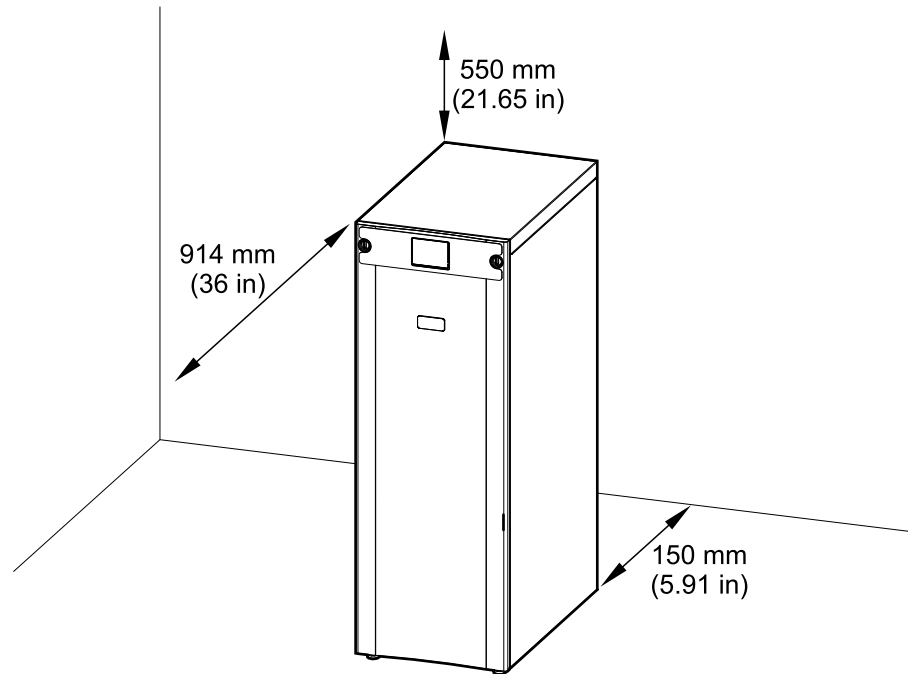

Environment

	Operating	Storage
Temperature	0 °C to 50 °C (32 °F to 122 °F) with load derating above 40 °C (104 °F). ⁹	-15 °C to 40 °C (5 °F to 104 °F) for systems with batteries. -25 °C to 55 °C (-13 °F to 131 °F) for systems without batteries.
Relative humidity	5-95% non-condensing	10-80% non-condensing
Elevation	Designed for operation in 0-3000 m (0-10000 feet) elevation. Derating required from 1000-3000 m (3300-10000 feet): Up to 1000 m (3300 feet): 1.000 Up to 1500 m (5000 feet) : 0.975 Up to 2000 m (6600 feet): 0.950 Up to 2500 m (8300 feet): 0.925 Up to 3000 m (10000 feet): 0.900	
Audible noise one meter (three feet) from unit	480 V: 57 dB at 70% load, 64 dB at 100% load 208 V: 60 dB at 70% load, 68 dB at 100% load	
Protection class	IP21	
Color	RAL 9003, gloss level 85%	

9. For temperatures between 40 °C (104 °F) and 50 °C (122 °F), derate the load power rating with 2.5% per °C.

Heat Dissipation in BTU/hr

480 V UPS

Normal Operation

UPS rating	20 kW	30 kW	40 kW	50 kW	60 kW	80 kW	100 kW	120 kW	150 kW
25% load	1169	1353	1522	1690	2242	2791	3114	4041	4913
50% load	1522	1862	2188	2530	3382	4093	4838	6111	7638
75% load	1862	2389	2922	3584	4420	5576	6944	8516	10645
100% load	2188	2922	3845	4915	5894	7449	9499	11788	14735

ECO Mode

UPS rating	20 kW	30 kW	40 kW	50 kW	60 kW	80 kW	100 kW	120 kW	150 kW
25% load	567	589	619	657	885	989	1055	1243	1422
50% load	619	680	741	814	1033	1261	1396	1650	1803
75% load	680	946	883	971	1238	1543	1769	2163	2316
100% load	741	883	1014	1137	1442	1847	1959	2470	3088

eConversion

UPS rating	20 kW	30 kW	40 kW	50 kW	60 kW	80 kW	100 kW	120 kW	150 kW
25% load	913	919	965	972	1312	1598	1607	2088	2477
50% load	965	981	1035	1024	1453	1664	1706	2485	2845
75% load	981	1024	1088	1132	1707	1812	1998	2787	3484
100% load	1035	1088	1158	1184	1858	1964	2211	3300	4125

Battery Operation

UPS rating	20 kW	30 kW	40 kW	50 kW	60 kW	80 kW	100 kW	120 kW	150 kW
25% load	1109	1331	1570	1834	2749	3003	3412	5045	5328
50% load	1570	2098	2593	3071	4041	4777	5801	7861	9002
75% load	2098	2841	3685	4478	5401	6756	8445	10802	13092
100% load	2593	3685	4777	5971	6982	9008	11601	14402	18003

208 V UPS

10 kW	Normal operation			ECO mode		
Voltage (V)	200	208	220	200	208	220
25% load	911	886	861	565	585	559
50% load	1219	1197	1145	627	643	616
75% load	1551	1511	1445	696	707	677
100% load	1949	1891	1783	763	772	732

10 kW	eConversion			Battery operation		
Voltage (V)	200	208	220	200	208	220
25% load	659	624	649	717	717	717
50% load	720	662	666	1024	1024	1024

10 kW	eConversion			Battery operation		
Voltage (V)	200	208	220	200	208	220
75% load	773	703	716	1331	1331	1331
100% load	836	736	736	1638	1638	1638

15 kW	Normal operation			ECO mode		
Voltage (V)	200	208	220	200	208	220
25% load	1066	1051	1008	603	612	588
50% load	1551	1511	1445	696	707	677
75% load	2190	2076	1964	797	796	768
100% load	2957	2802	2628	906	903	863

15 kW	eConversion			Battery operation		
Voltage (V)	200	208	220	200	208	220
25% load	685	641	675	870	870	870
50% load	773	703	716	1331	1331	1331
75% load	859	753	752	1804	1804	1804
100% load	939	821	821	2303	2303	2303

20 kW	Normal operation			ECO mode		
Voltage (V)	200	208	220	200	208	220
25% load	1219	1197	1145	627	643	616
50% load	1949	1891	1783	763	772	732
75% load	2957	2802	2628	906	903	863
100% load	4261	4019	3665	1058	1028	1002

20 kW	eConversion			Battery operation		
Voltage (V)	200	208	220	200	208	220
25% load	720	662	666	1024	1024	1024
50% load	836	736	736	1638	1638	1638
75% load	939	821	821	2303	2303	2303
100% load	1033	928	911	3071	3071	3071

25 kW	Normal operation			ECO mode		
Voltage (V)	200	208	220	200	208	220
25% load	1379	1339	1285	661	673	644
50% load	2418	2309	2156	832	835	800
75% load	3893	3683	3377	1021	986	967
100% load	6028	5526	4977	1215	1179	1143

25 kW	eConversion			Battery operation		
Voltage (V)	200	208	220	200	208	220
25% load	741	675	694	1173	1173	1173
50% load	889	774	786	1962	1962	1962
75% load	1015	906	892	2879	2879	2879
100% load	1146	1042	1015	3839	3839	3839

30 kW	Normal operation			ECO mode		
Voltage (V)	200	208	220	200	208	220
25% load	1749	1690	1632	845	818	818
50% load	2863	2749	2579	1044	1044	991
75% load	4380	4123	3868	1327	1248	1168
100% load	6530	6069	5498	1558	1453	1453

30 kW	eConversion			Battery operation		
Voltage (V)	200	208	220	200	208	220
25% load	900	873	900	1690	1690	1690
50% load	1097	1097	1097	2635	2635	2635
75% load	1327	1327	1248	3615	3615	3615
100% load	1663	1558	1453	4708	4708	4708

40 kW	Normal operation			ECO mode		
Voltage (V)	200	208	220	200	208	220
25% load	2215	2146	1935	970	969	938
50% load	3692	3589	3140	1253	1240	1192
75% load	5702	5487	4736	1616	1562	1479
100% load	8332	7756	6695	1890	1812	1747

40 kW	eConversion			Battery operation		
Voltage (V)	200	208	220	200	208	220
25% load	1070	1051	1056	1911	1911	1911
50% load	1217	1240	1194	3139	3139	3139
75% load	1418	1379	1322	4504	4504	4504
100% load	1808	1747	1679	6005	6005	6005

50 kW	Normal operation			ECO mode		
Voltage (V)	200	208	220	200	208	220
25% load	2549	2482	2204	1035	1038	1000
50% load	4619	4480	3878	1421	1402	1338
75% load	7592	7125	6118	1785	1737	1648
100% load	11734	10758	9080	2293	2170	2095

50 kW	eConversion			Battery operation		
Voltage (V)	200	208	220	200	208	220
25% load	1112	1103	1135	2175	2175	2175
50% load	1340	1291	1231	3839	3839	3839
75% load	1730	1686	1628	5630	5630	5630
100% load	2116	2064	1993	7677	7677	7677

60 kW	Normal operation			ECO mode		
Voltage (V)	200	208	220	200	208	220
25% load	3034	2977	2863	1204	1204	1204
50% load	5498	5271	4933	1663	1663	1558

60 kW	Normal operation			ECO mode		
Voltage (V)	200	208	220	200	208	220
75% load	9103	8417	7737	2179	2179	2021
100% load	13990	12828	11679	2905	2695	2695

60 kW	eConversion			Battery operation		
Voltage (V)	200	208	220	200	208	220
25% load	1365	1365	1365	3207	3149	3149
50% load	1875	1769	1769	5158	5045	4933
75% load	2337	2337	2179	7568	7231	6895
100% load	2905	2905	2695	10090	9641	9193

75 kW	Normal operation			ECO mode		
Voltage (V)	200	208	220	200	208	220
25% load	3721	3650	3507	1371	1371	1371
50% load	6872	6589	6026	2079	1947	1947
75% load	11379	10735	9671	2724	2724	2526
100% load	17487	16324	14599	3631	3631	3369

75 kW	eConversion			Battery operation		
Voltage (V)	200	208	220	200	208	220
25% load	1572	1639	1572	3436	3436	3436
50% load	2211	2211	2079	6026	6026	6026
75% load	2921	2921	2724	8828	8828	10949
100% load	3895	3631	3631	12051	12051	12051

Heat Dissipation for Maintenance Bypass Cabinet with Transformer in BTU/hr

	Maintenance bypass cabinet with input transformer			Maintenance bypass cabinet with output transformer		
Commercial reference	GVSBPIT25B	GVSBPIT50	GVSBPIT75	GVSBPOT50B	GVSBPOT100	GVSBPOT150
100% load	2700	5300	8000	5300	10600	16000

Heat Dissipation for Input Transformer Cabinet in BTU/hr

Commercial reference	GVSBPIT100	GVSBPIT150
100% load	3077	3077

Drawings

NOTE: A comprehensive set of drawings is available on www.se.com.

NOTE: These drawings are for reference ONLY – subject to change without notice.

20-50 kW 480 V and 10-25 kW 208 V UPS

DUAL MAINS

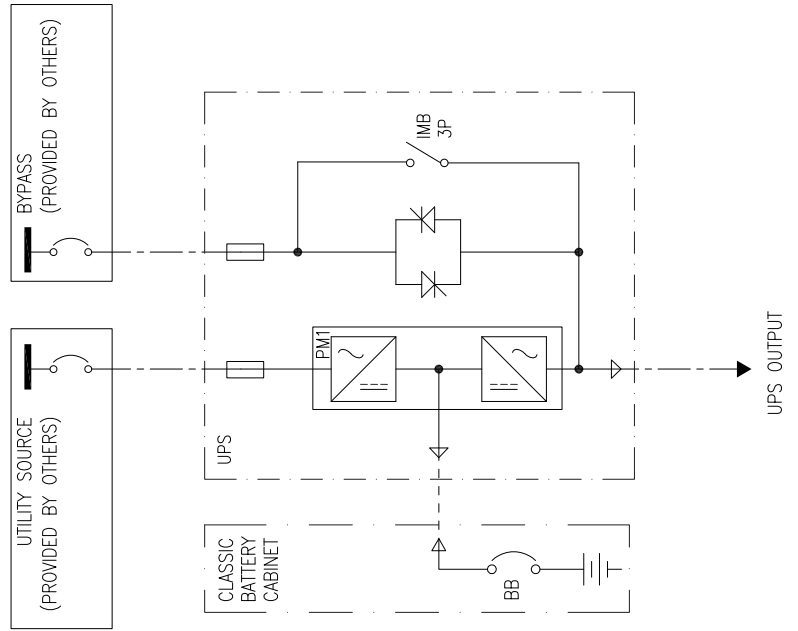

SINGLE MAINS

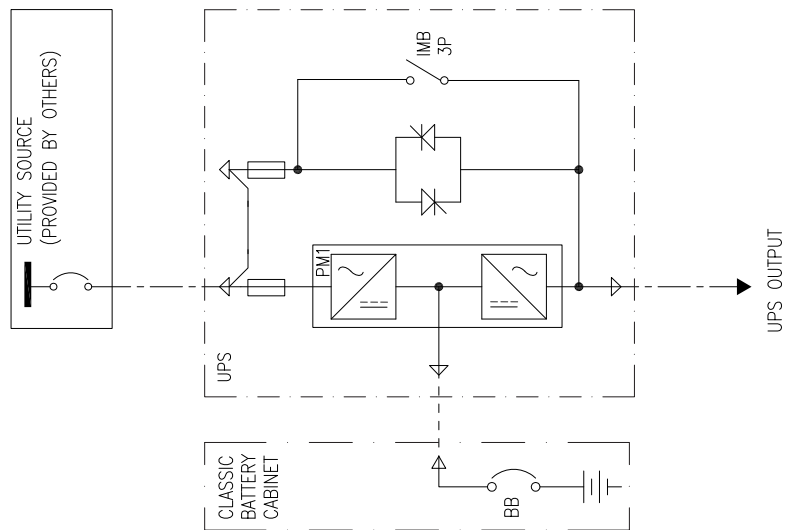

60-100 kW 480 V and 30-50 kW 208 V UPS

DUAL MAINS

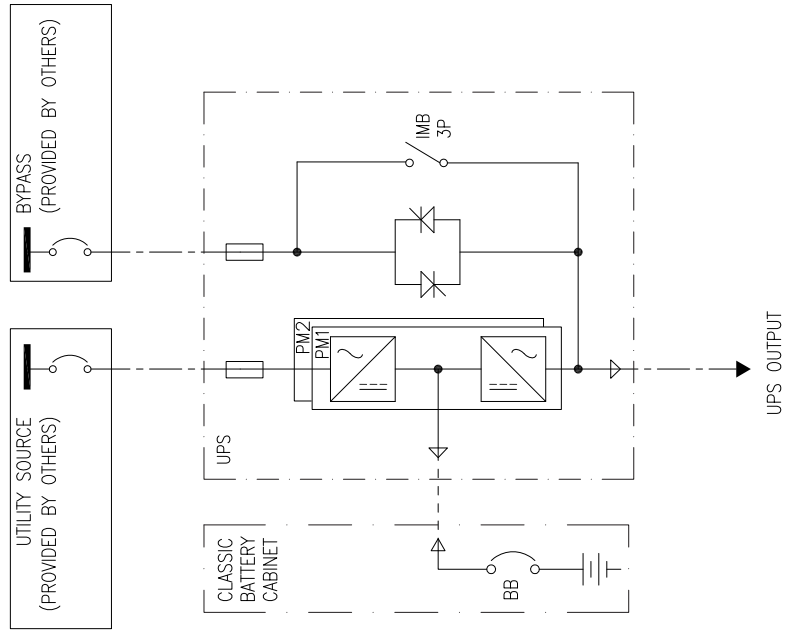

SINGLE MAINS

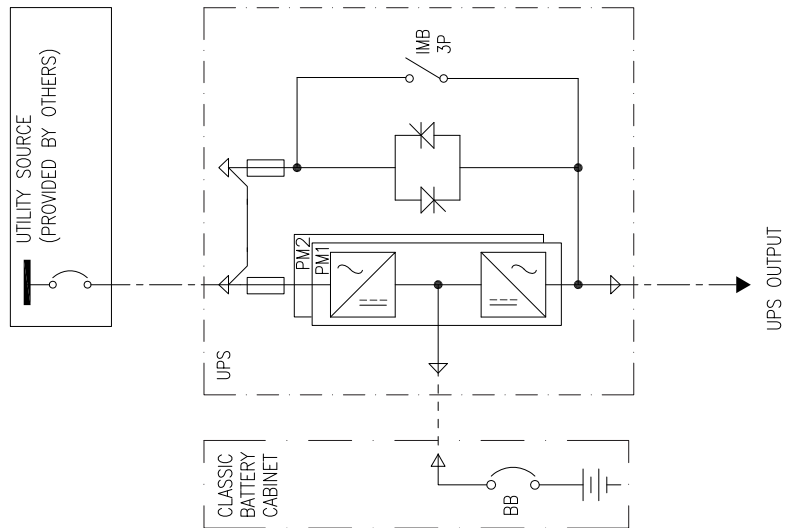

120-150 kW 480 V and 60-75 kW 208 V UPS

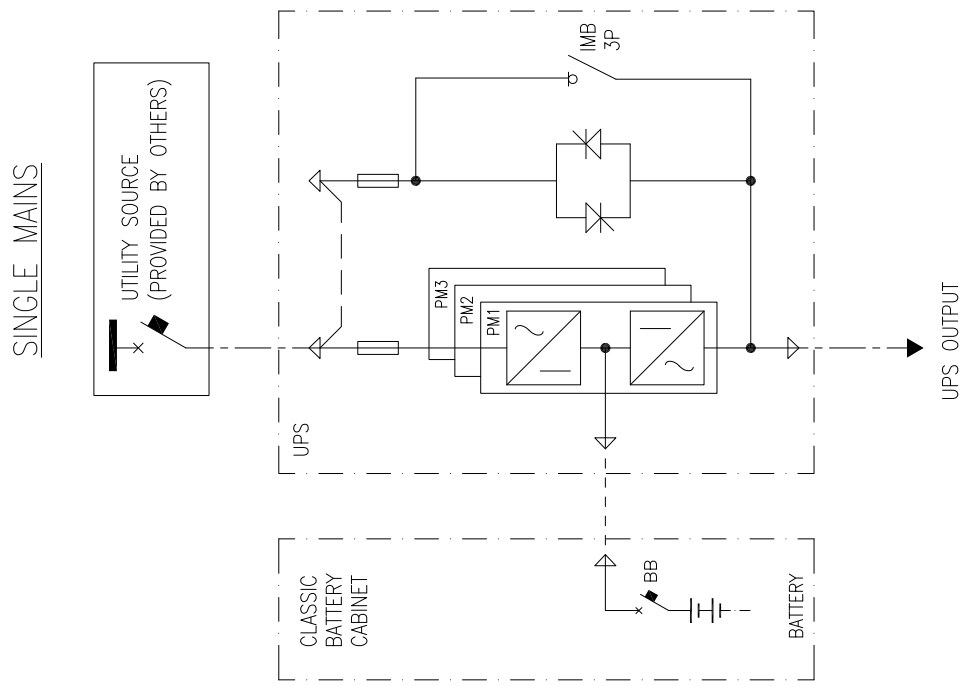
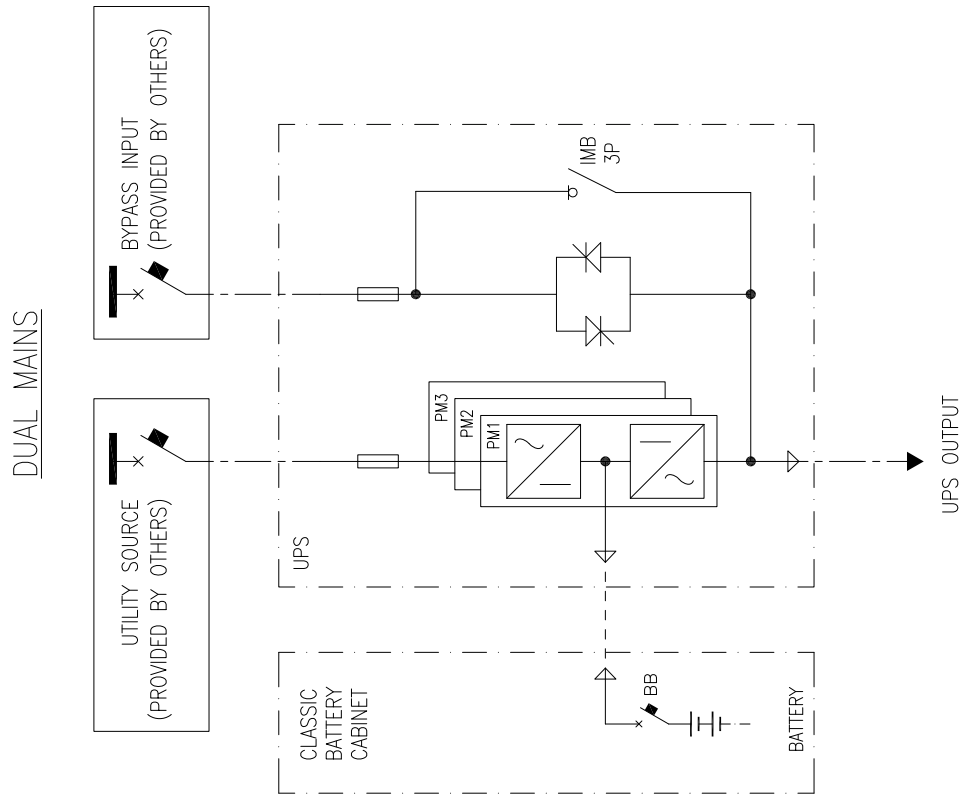

Options

Configuration Options

- Compact design, high density technology, and modular architecture
- Single or dual mains
- Up to 4+0 UPSs in parallel for capacity
- Up to 3+1 UPSs in parallel for redundancy
- Default rear or bottom cable entry
- ECO mode
- eConversion mode
- EcoStruxure IT compatible
- Generator compatible
- Touchscreen LCD
- Replacement of power module in any operation mode (Live Swap)¹⁰
- Halogen-free cables for scalable UPS models.
- Supported battery types: VRLA, Lithium-ion, and NiCd.

10. In all systems configured for Live Swap.

Hardware Options

NOTE: All hardware options listed here may not be available in all regions.

Power Module

- Power module 50 kW 480 V/25 kW 208 V (GVPM50KD)
- Power module 20 kW 480 V/10 kW 208 V (GVPM20KD)

Galaxy Lithium-Ion Battery Cabinet

Battery cabinet including Lithium-Ion batteries and battery breaker.

- Galaxy Lithium-Ion battery cabinet with 13 battery modules (LIBSESMG13UL)
- Galaxy Lithium-Ion battery cabinet with 16 battery modules (LIBSESMG16UL)

Modular Battery Cabinet

Modular battery cabinet including battery breaker.

- Modular battery cabinet for up to six smart modular battery strings (GVSMODBC6). Can be installed adjacent to the UPS with the use of optional installation kit GVSOPT030.
- Modular battery cabinet for up to nine smart modular battery strings (GVSMODBC9). Can only be installed remote to the UPS.

Battery Modules

9 Ah smart high capacity battery modules for use with GVSMODBC6 and GVSMODBC9:

- Galaxy VS 9 Ah Smart High Capacity Battery Module (GVSBTHU)
- Galaxy VS 9 Ah Smart Modular High Capacity Battery String (GVSBTH4)

9 Ah smart long-life high capacity battery modules for use with GVSMODBC6 and GVSMODBC9:

- Galaxy VS 9 Ah Smart Long-Life High Capacity Battery Module (GVSBTHULL)
- Galaxy VS 9 Ah Smart Modular Long-Life High Capacity Battery String (GVSBTH4LL)

NOTE: Always use the same battery module type in the UPS system. Do not mix different battery module types.

Classic Battery Cabinets

Classic battery cabinet including batteries and battery breaker.

- 700 mm (27.56 in) wide, classic battery cabinet (GVSCBT1, GVSCBT2, GVSCBT3)
- 1000 mm (39.37 in) wide, classic battery cabinet (GVSCBT4, GVSCBT5)
- 700 mm (27.56 in) wide, classic battery cabinet, seismic compliant (GVSCBT1ST, GVSCBT2ST, GVSCBT3ST)

- 1000 mm (39.37 in) wide, classic battery cabinet, seismic compliant (GVSCBT4ST, GVSCBT5ST)
- 1127 mm (44.37 in) wide, classic battery cabinet, seismic compliant (GVSCBT6ST, GVSCBT7ST)

Maintenance Bypass Panel

Maintenance bypass panel for complete isolation of the UPS during service operations. Only for single UPS.

- 10-30 kW 208 V, 20-60 kW 480 V maintenance bypass panel (GVSBPSU60G-WP)
- 25-50 kW 208 V, 50-100 kW 480 V maintenance bypass panel (GVSBPSU100G-WP)

Maintenance Bypass Cabinet

Maintenance bypass cabinet for complete isolation of the UPS during service operations. Only for single UPS.

- 10-40 kW 208 V, 20-80 kW 480 V maintenance bypass cabinet (GVSBPSU80G)
- 50-75 kW 208 V, 100-150 kW 480 V maintenance bypass cabinet (GVSBPSU150G)

Maintenance Bypass Cabinet with Input Transformer

Maintenance bypass cabinet with input transformer for complete isolation of the UPS during service operations. Only for single 208 V UPS.

- 10-25 kW 480 V or 600 V in, 208 V out, maintenance bypass cabinet with input transformer (GVSBPIT25B)
- 30-50 kW 480 V or 600 V in, 208 V out, maintenance bypass cabinet with input transformer (GVSBPIT50)
- 60-75 kW 480 V or 600 V in, 208 V out, maintenance bypass cabinet with input transformer (GVSBPIT75)

Maintenance Bypass Cabinet with Output Transformer

Maintenance bypass cabinet with output transformer for complete isolation of the UPS during service operations. Only for single 480 V UPS.

- 20-50 kW 480 V in, 208 V out, maintenance bypass cabinet with output transformer (GVSBPOT50B)
- 60-100 kW 480 V in, 208 V out, maintenance bypass cabinet with output transformer (GVSBPOT100)
- 120-150 kW 480 V in, 208 V out, maintenance bypass cabinet with output transformer (GVSBPOT150)

Input Transformer Cabinet

Input transformer cabinet including input breaker. For single mains or dual mains.

- 20-100 kW 600 V in, 480 V out, input transformer cabinet (GVSBPIT100)
- 120-150 kW 600 V in, 480 V out, input transformer cabinet (GVSBPIT150)

Remote Alarm Panel

- Remote alarm panel (GVSOPT036)

Optional Installation Kits

- Seismic kit for UPS (GVSOPT002)
- Parallel kit for UPS (GVSOPT006)
- IP22 kit for UPS (GVSOPT026)
- Mounting skid kit for the UPS or GVSMODBC6 for marine or industrial installation (GVSOPT027)
- Cable kit for two or more GVSCBT6ST or GVSCBT7ST (GVSOPT028)
- Seismic kit for GVSBPOT150 (GVSOPT029)
- Cable kit for GVSMODBC6 installed adjacent to the UPS (GVSOPT030)
- IP52 kit for the UPS (GVSOPT033)
- IP52 kit for GVSMODBC6 (GVSOPT034)
- Live Swap kit for the UPS (GVSOPT038)

Optional Network Management Card

- Network Management Card LCES2 with Modbus, Ethernet and AUX sensors (AP9644)

Air Filter

- Air filter kit (GVSOPT001)

Temperature Sensors

- Extra temperature sensor for second classic battery bank (0J-0M-1160). Not for use with modular battery cabinet solution.
- Temperature sensor for network management card (AP9335T)
- Temperature/humidity sensor for network management card (AP9335TH)

Weights and Dimensions for Options

NOTE: Not all options listed here are available for all UPS models. Refer to the hardware options list for the relevant UPS model.

Maintenance Bypass Cabinet Shipping Weights and Dimensions

Commercial reference	Weight kg (lbs)	Height mm (in)	Width mm (in)	Depth mm (in)
GVSBPUS80G	125 (275.58)	1660 (65.35)	635 (25)	990 (38.98)
GVSBPUS150G	135 (297.62)	1660 (65.35)	635 (25)	990 (38.98)

Maintenance Bypass Cabinet Weights and Dimensions

Commercial reference	Weight kg (lbs)	Height mm (in)	Width mm (in)	Depth mm (in)
GVSBPUS80G	110 (242.51)	1485 (58.46)	318 (12.52)	850 (33.46)
GVSBPUS150G	120 (264.55)	1485 (58.46)	318 (12.52)	850 (33.46)

Maintenance Bypass Cabinet with Transformer Shipping Weights and Dimensions

Commercial reference	Weight kg (lbs)	Height mm (in)	Width mm (in)	Depth mm (in)
GVSBPIT25B	425 (936.97)	1670 (65.75)	800 (31.5)	990 (39.98)
GVSBPIT50	560 (1234.59)	1670 (65.75)	800 (31.5)	990 (39.98)
GVSBPIT75	650 (1433)	1670 (65.75)	800 (31.5)	990 (39.98)
GVSBPOT50B	560 (1234.59)	1670 (65.75)	800 (31.5)	990 (39.98)
GVSBPOT100	675 (1488.12)	1670 (65.75)	800 (31.5)	990 (39.98)
GVSBPOT150	930 (2050.29)	1670 (65.75)	1020 (40.15)	1010 (39.76)

Maintenance Bypass Cabinet with Transformer Weights and Dimensions

Commercial reference	Weight kg (lbs)	Height mm (in)	Width mm (in)	Depth mm (in)
GVSBPIT25B	395 (870.83)	1485 (58.46)	600 (23.62)	836 (32.91)
GVSBPIT50	530 (1168.45)	1485 (58.46)	600 (23.62)	836 (32.91)
GVSBPIT75	620 (1364)	1485 (58.46)	600 (23.62)	836 (32.91)
GVSBPOT50B	530 (1168.45)	1485 (58.46)	600 (23.62)	836 (32.91)
GVSBPOT100	645 (1421.98)	1485 (58.46)	600 (23.62)	836 (32.91)
GVSBPOT150	890 (1958)	1485 (58.46)	800 (31.50)	836 (32.91)

Classic Battery Cabinet Shipping Weights and Dimensions

Commercial reference	Weight kg (lbs)	Height mm (in)	Width mm (in)	Depth mm (in)
GVSCBT1	619 (1364.66)	1688 (66.46)	1372 (54.02)	998 (39.29)
GVSCBT1ST	662 (1459.46)	1688 (66.46)	1372 (54.02)	998 (39.29)
GVSCBT2	708 (1560.87)	1688 (66.46)	1372 (54.02)	998 (39.29)
GVSCBT2ST	751 (1655.67)	1688 (66.46)	1372 (54.02)	998 (39.29)
GVSCBT3	1009 (2224.47)	1688 (66.46)	1372 (54.02)	998 (39.29)
GVSCBT3ST	1053 (2321.47)	1688 (66.46)	1372 (54.02)	998 (39.29)
GVSCBT4	1370 (3020.34)	1688 (66.46)	1372 (54.02)	998 (39.29)
GVSCBT4ST	1422 (3134.98)	1688 (66.46)	1372 (54.02)	998 (39.29)
GVSCBT5	1569 (3459.06)	1688 (66.46)	1372 (54.02)	998 (39.29)
GVSCBT5ST	1622 (3575.90)	1688 (66.46)	1372 (54.02)	998 (39.29)
GVSCBT6ST	1832 (4031)	1688 (66.46)	1372 (54.02)	998 (39.29)
GVSCBT7ST	1850 (4070)	1688 (66.46)	1372 (54.02)	998 (39.29)

Classic Battery Cabinet Weights and Dimensions

Commercial reference	Weight kg (lbs)	Height mm (in)	Width mm (in)	Depth mm (in)
GVSCBT1	573 (1263.25)	1485 (58.46)	700 (27.56)	840 (33.07)
GVSCBT1ST	617 (1360.25)	1485 (58.46)	700 (27.56)	840 (33.07)
GVSCBT2	662 (1459.46)	1485 (58.46)	700 (27.56)	840 (33.07)
GVSCBT2ST	706 (1556.46)	1485 (58.46)	700 (27.56)	840 (33.07)
GVSCBT3	964 (2125.26)	1485 (58.46)	700 (27.56)	840 (33.07)
GVSCBT3ST	1007 (2220.06)	1485 (58.46)	700 (27.56)	840 (33.07)
GVSCBT4	1324 (2918.92)	1485 (58.46)	1000 (39.37)	840 (33.07)
GVSCBT4ST	1377 (3035.77)	1485 (58.46)	1000 (39.37)	840 (33.07)
GVSCBT5	1524 (3359.85)	1485 (58.46)	1000 (39.37)	840 (33.07)
GVSCBT5ST	1576 (3474.49)	1485 (58.46)	1000 (39.37)	840 (33.07)
GVSCBT6ST	1736 (3828)	1485 (58.46)	1127 (44.37)	840 (33.07)
GVSCBT7ST	1736 (3828)	1485 (58.46)	1127 (44.37)	840 (33.07)

Modular Battery Cabinet Shipping Weights and Dimensions

Commercial reference	Weight kg (lbs)	Height mm (in)	Width mm (in)	Depth mm (in)
GVSMODBC6	175 (385.8)	1664 (65.51)	635 (25)	990 (38.97)
GVSMODBC9	206 (454.15)	2082 (81.96)	755 (29.72)	1010 (39.76)

NOTE: The modular battery cabinet is shipped without battery strings installed.

Modular Battery Cabinet Weights and Dimensions

Commercial reference	Weight kg (lbs)	Height mm (in)	Width mm (in)	Depth mm (in)
GVSMODBC6 – Empty – With six battery strings	145 (319.67) 913 (2012.82)	1485 (58.46)	521 (20.51)	847 (33.35)
GVSMODBC9 – Empty – With nine battery strings	186 (410) 1338 (2950)	1970 (77.56)	550 (21.65)	847 (33.35)

NOTE: One battery module weighs approximately 32 kg (70.5 lbs).

Input Transformer Cabinet Shipping Weights and Dimensions

Commercial reference	Weight kg (lbs)	Height mm (in)	Width mm (in)	Depth mm (in)
GVSBPIT100	390 (860)	1670 (65.75)	800 (31.50)	990 (39)
GVSBPIT150	390 (860)	1670 (65.75)	800 (31.50)	990 (39)

Input Transformer Cabinet Weights and Dimensions

Commercial reference	Weight kg (lbs)	Height mm (in)	Width mm (in)	Depth mm (in)
GVSBPIT100 with surge protection device (SSP08EMA12) installed	370 (816)	1800 (70.86)	600 (23.62)	836 (32.91)
GVSBPIT150 with surge protection device (SSP08EMA12) installed	370 (816)	1800 (70.86)	600 (23.62)	836 (32.91)

Remote Alarm Panel Shipping Weights and Dimensions

Commercial reference	Weight kg (lbs)	Height mm (in)	Width mm (in)	Depth mm (in)
GVSOPT036	19 (42)	581 (22.87)	468 (18.42)	366 (14.40)

Remote Alarm Panel Weights and Dimensions

Commercial reference	Weight kg (lbs)	Height mm (in)	Width mm (in)	Depth mm (in)
GVSOPT036	14 (31)	400 (15.74)	300 (11.81)	178 (7.00)

Limited Factory Warranty

One-Year Factory Warranty

The limited warranty provided by Schneider Electric in this Statement of Limited Factory Warranty applies only to products you purchase for your commercial or industrial use in the ordinary course of your business.

Terms of Warranty

Schneider Electric warrants that the product shall be free from defects in materials and workmanship for a period of one year from the date of product start-up when start-up is performed by Schneider Electric-authorized service personnel and occurs within six months of the Schneider Electric shipment date. This warranty covers repairing or replacing any defective parts including on-site labor and travel. In the event that the product fails to meet the foregoing warranty criteria, the warranty covers repairing or replacing defective parts at the sole discretion of Schneider Electric for a period of one year from the shipment date. For Schneider Electric cooling solutions, this warranty does not cover circuit breaker resetting, loss of refrigerant, consumables, or preventive maintenance items. Repair or replacement of a defective product or part thereof does not extend the original warranty period. Any parts furnished under this warranty may be new or factory-remanufactured.

Non-transferable Warranty

This warranty is extended to the first person, firm, association or corporation (herein referred to by "You" or "Your") for whom the Schneider Electric product specified herein has been purchased. This warranty is not transferable or assignable without the prior written permission of Schneider Electric.

Assignment of Warranties

Schneider Electric will assign you any warranties which are made by manufacturers and suppliers of components of the Schneider Electric product and which are assignable. Any such warranties are assigned "AS IS" and Schneider Electric makes no representation as to the effectiveness or extent of such warranties, assumes no responsibility for any matters which may be warranted by such manufacturers or suppliers and extends no coverage under this Warranty to such components.

Drawings, Descriptions

Schneider Electric warrants for the warranty period and on the terms of the warranty set forth herein that the Schneider Electric product will substantially conform to the descriptions contained in the Schneider Electric Official Published Specifications or any of the drawings certified and agreed to by contract with Schneider Electric if applicable thereto ("Specifications"). It is understood that the Specifications are not warranties of performance and not warranties of fitness for a particular purpose.

Exclusions

Schneider Electric shall not be liable under the warranty if its testing and examination disclose that the alleged defect in the product does not exist or was caused by end user or any third person misuse, negligence, improper installation or testing. Further, Schneider Electric shall not be liable under the warranty for unauthorized attempts to repair or modify wrong or inadequate electrical voltage

or connection, inappropriate on-site operation conditions, corrosive atmosphere, repair, installation, start-up by non-Schneider Electric designated personnel, a change in location or operating use, exposure to the elements, Acts of God, fire, theft, or installation contrary to Schneider Electric recommendations or specifications or in any event if the Schneider Electric serial number has been altered, defaced, or removed, or any other cause beyond the range of the intended use.

THERE ARE NO WARRANTIES, EXPRESS OR IMPLIED, BY OPERATION OF LAW OR OTHERWISE, OF PRODUCTS SOLD, SERVICED OR FURNISHED UNDER THIS AGREEMENT OR IN CONNECTION HEREWITH. SCHNEIDER ELECTRIC DISCLAIMS ALL IMPLIED WARRANTIES OF MERCHANTABILITY, SATISFACTION AND FITNESS FOR A PARTICULAR PURPOSE. SCHNEIDER ELECTRIC EXPRESS WARRANTIES WILL NOT BE ENLARGED, DIMINISHED, OR AFFECTED BY AND NO OBLIGATION OR LIABILITY WILL ARISE OUT OF, SCHNEIDER ELECTRIC RENDERING OF TECHNICAL OR OTHER ADVICE OR SERVICE IN CONNECTION WITH THE PRODUCTS. THE FOREGOING WARRANTIES AND REMEDIES ARE EXCLUSIVE AND IN LIEU OF ALL OTHER WARRANTIES AND REMEDIES. THE WARRANTIES SET FORTH ABOVE CONSTITUTE SCHNEIDER ELECTRIC SOLE LIABILITY AND PURCHASER'S EXCLUSIVE REMEDY FOR ANY BREACH OF SUCH WARRANTIES. SCHNEIDER ELECTRIC WARRANTIES RUN ONLY TO PURCHASER AND ARE NOT EXTENDED TO ANY THIRD PARTIES.

IN NO EVENT SHALL SCHNEIDER ELECTRIC, ITS OFFICERS, DIRECTORS, AFFILIATES OR EMPLOYEES BE LIABLE FOR ANY FORM OF INDIRECT, SPECIAL, CONSEQUENTIAL OR PUNITIVE DAMAGES, ARISING OUT OF THE USE, SERVICE OR INSTALLATION, OF THE PRODUCTS, WHETHER SUCH DAMAGES ARISE IN CONTRACT OR TORT, IRRESPECTIVE OF FAULT, NEGLIGENCE OR STRICT LIABILITY OR WHETHER SCHNEIDER ELECTRIC HAS BEEN ADVISED IN ADVANCE OF THE POSSIBILITY OF SUCH DAMAGES, SPECIFICALLY, SCHNEIDER ELECTRIC IS NOT LIABLE FOR ANY COSTS, SUCH AS LOST PROFITS OR REVENUE, LOSS OF EQUIPMENT, LOSS OF USE OF EQUIPMENT, LOSS OF SOFTWARE, LOSS OF DATA, COSTS OF SUBSTITUANTS, CLAIMS BY THIRD PARTIES, OR OTHERWISE.

NO SALESMAN, EMPLOYEE OR AGENT OF SCHNEIDER ELECTRIC IS AUTHORIZED TO ADD TO OR VARY THE TERMS OF THIS WARRANTY. WARRANTY TERMS MAY BE MODIFIED, IF AT ALL, ONLY IN WRITING SIGNED BY AN SCHNEIDER ELECTRIC OFFICER AND LEGAL DEPARTMENT.

Warranty Claims

Customers with warranty claims issues may access the SCHNEIDER ELECTRIC worldwide customer support network through the SCHNEIDER ELECTRIC web site: <http://www.schneider-electric.com>. Select your country from the country selection pull-down menu. Open the Support tab at the top of the web page to obtain contact information for customer support in your region.

Schneider Electric
35 rue Joseph Monier
92500 Rueil Malmaison
France

+ 33 (0) 1 41 29 70 00



As standards, specifications, and design change from time to time,
please ask for confirmation of the information given in this publication.

© 2018 – 2023 Schneider Electric. All rights reserved.

990-91140E-001